

Feel the water

GENEBRE

Colección Grifería Cocina y Baño
Tap Collection Kitchen & Bathroom
2024—2025



GENEBRE

Tenemos una visión común que es el faro que guía nuestro rumbo: cuidar del agua, el recurso natural más valioso y esencial para la vida. Lo hacemos con las soluciones que aportamos hoy en día y también con las que descubriremos en el futuro.

We have a common vision which is our guiding light: taking care of water, the most valuable and essential natural resource for life. We do this with the solutions we provide today and also with those we will discover in the future.

¿Deseas más información?

Do you want more information?



www.genebre.es

Síguenos / Follow us:



Contacta con nosotros:

Contact us:

GENEBRE GROUP

Edificio Genebre
Avda. Joan Carles I, 46-48
Distrito económico de l'Hospitalet
08908 l'Hospitalet de Llobregat
Barcelona (SPAIN)
Teléfono / Phone +34 93 298 80 00
www.genebre.es

CONTACTO COMERCIAL
COMMERCIAL CONTACT

España / Spain

Teléfono / Phone +34 93 298 80 01
Fax: + 34 93 298 80 06
griferia@genebre.es

Europa / Europe

Teléfono / Phone +34 93 298 80 15

Europa este / East Europe

Teléfono / Phone +34 93 298 80 19

América latina / Latin America

Teléfono / Phone +34 93 298 80 17

América del norte / North America

Teléfono / Phone +34 93 298 80 00
Fax: + 34 93 298 80 08

www.genebre.com

exportacion@genebre.es

OTROS TELÉFONOS

OTHER TELEPHONE NUMBERS

Centralita / Central telephone number

Teléfono / Phone +34 93 298 80 00

Administración / Administration

Teléfono / Phone +34 93 298 80 02
Fax: + 34 93 298 80 07

Servicio de atención técnica al cliente /
Technical support

Teléfono / Phone +34 902 504 203

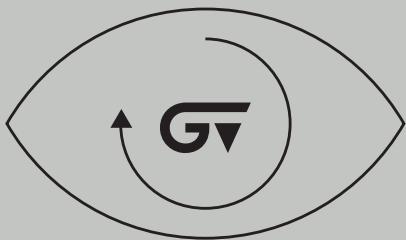

Cuidamos del agua desde el origen hasta el retorno al medio a través de una amplia gama de productos para cada fase

We take care of water from origin to return to source through a wide range of products for each phase

En Genebre Group completamos el ciclo del agua pensando en las personas y el planeta. Porque cuando llega a nuestros hogares, espacios públicos o privados, aplicamos soluciones para optimizar y ahorrar tanto agua como energía. Siempre pensando en conseguir máxima eficiencia, calidad y confort.

At Genebre Group, we complete the water cycle with people and the planet in mind. Because when it reaches our homes, public or private spaces, we apply solutions to optimize and save both water and energy. Always thinking about achieving maximum efficiency, quality and comfort.

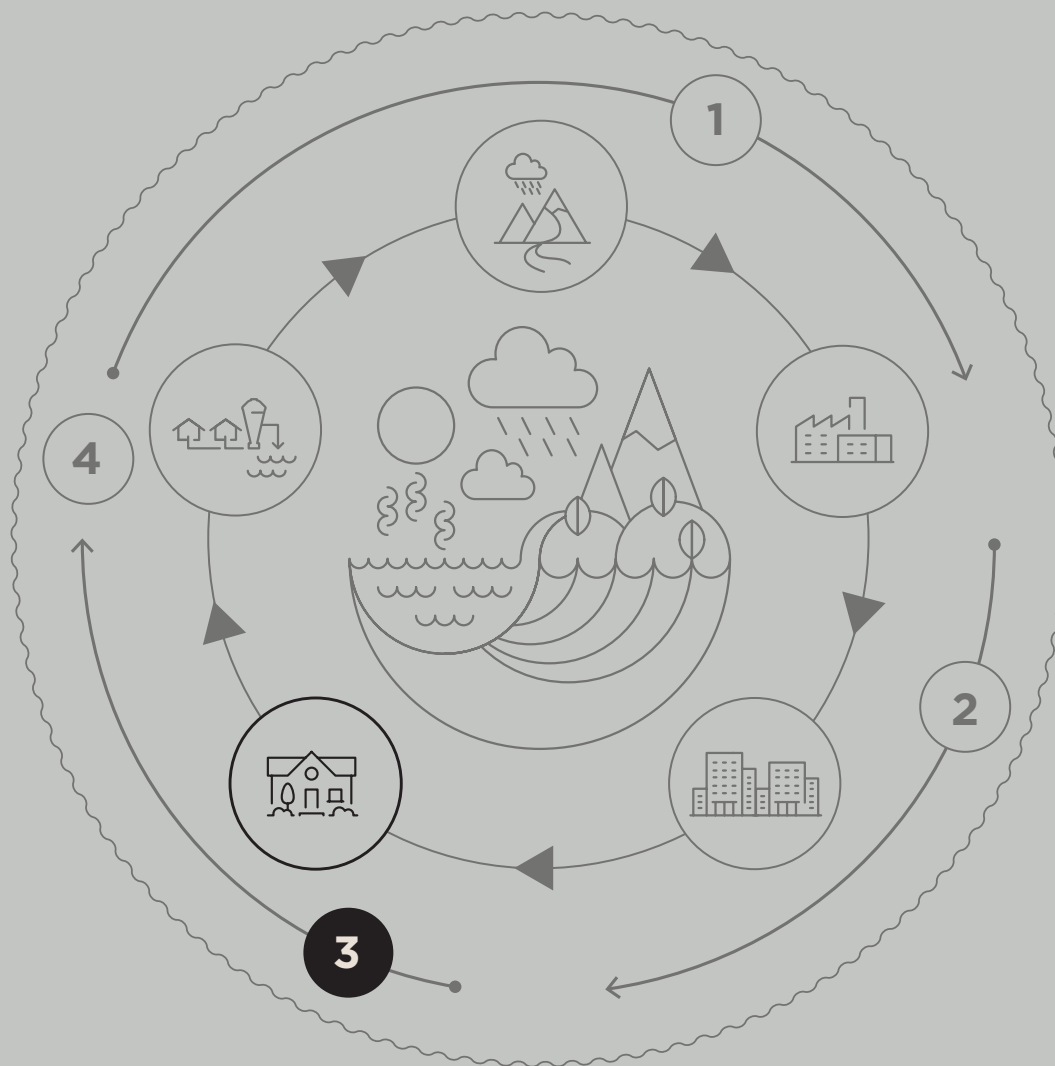

BIENESTAR, DISEÑO Y OPTIMIZACIÓN.

Máxima funcionalidad, espíritu sostenible.
Diseñamos sistemas, soluciones y diversidad de productos que promueven el bienestar de las personas desde la eficiencia y la optimización tanto del agua como de la energía.

WELL-BEING, DESIGN AND OPTIMIZATION.

Maximum functionality, sustainable spirit.
We design systems, solutions and product diversity that promote people's well-being based on efficiency and optimization of both water and energy.

Cerca de ti en cualquier momento

Close to you at any time





¿Conoces todas las ventajas de nuestra página web?

En Genebre trabajamos día a día para seguir mejorando todos nuestros canales de comunicación contigo. Especialmente a través de nuestra web. Por eso, ya seas profesional, instalador, colaborador, usuario o cliente, en nuestro site encontrarás toda la información que necesites. Las 24 horas del día, los 365 días del año. Por ejemplo:

- > Descubre nuestras últimas novedades
- > Información de nuestros productos
- > Consulta Fichas técnicas
- > Descarga Manuales e Instrucciones
- > Accede al Área de descargas y últimas noticias
- > Además, si eres cliente activo Genebre podrás beneficiarte del Área Exclusiva para clientes.

Do you know all the advantages of our website?

At Genebre we work every day to continue improving all our communication channels with you. Especially through our website. Therefore, whether you are a professional, installer, collaborator, user or client, on our site you will find all the information you need. 24 hours a day, 365 days a year.

For example:

- > *Discover our latest news*
- > *Information about our products*
- > *Consult technical specifications*
- > *Download Manuals and Instructions*
- > *Access the downloads and latest news area*
- > *Additionally, if you are an active Genebre customer you can benefit from the Exclusive Area for customers.*



¿Eres cliente de Genebre?
Solicita el alta aquí



*Are you a Genebre customer?
Request registration here*

GENEBRE

Índice

Index

Cuidamos del agua
We take care of water **p. 02**

Cerca de ti
Close to you **p. 04**

Feel the Water **p. 08**

Feel the Quality **p. 10**

Más opciones ecológicas
More green options **p. 12**

Tecnología
Technology **p. 14**

Novedades 2024
News 2024 **p. 16**

Acabados
Finishes **p. 18**

Medidas
Measures **p. 20**

Grifería para Baños
Bathroom taps **p. 22**

Kloe	24
Koral	32
Oslo	42
Kode	54
Klip	62
Tau	68
Tau 2	78
Kenjo	84
K8	92
Ge2	98
New Regent Classic	106
New Regent	112
Gamma	118
Ixo	124
Kross	128
Kalo	132
Style shower	136
GEBOX system	148

Grifería para Cocinas

Kitchen taps

p. 150

Grifería de cocina para encimeras

Countertop sink mixers

152

Grifería de cocina para filtrado

Sink mixers for filtration

158

Grifería de cocina extraíbles

Pull out sink mixers

160

Grifería de cocina con muelle

Sink mixers with spring

164

Grifería de cocina mural

Wall-mounted sink mixers

166

Grifería de cocina abatible

Folding sink mixers

168

Grifería de cocina selección inox

Stainless steel selection sink mixers

169

Grifería de cocina Classic

Classic sink mixers

172

Grifería de cocina de 1 agua

One-water sink taps

182

Accesorios

Accessories

p.184

Packaging

p.206

Punto de venta

Point of sale

p.207

Recambios

Spare parts

p.208

Información técnica

Technical information

p.226

Índice por referencia

Index by reference

p.292

Condiciones de venta

Sales conditions

p.298

Feel the water

A close-up photograph of a hand splashing water against a black background. The water is captured in mid-air, creating a complex, crystalline structure of droplets and bubbles. The hand is visible on the right side, with fingers slightly curled. The lighting highlights the texture and movement of the water.



El agua es vida. Sólo con verla y oírla, aumenta el flujo sanguíneo en el cerebro y el corazón, y nos relaja.

En Genebre sabemos la gran variedad de beneficios que sólo el agua puede ofrecer. Por eso seguimos mejorando continuamente nuestros productos para que tu experiencia con el agua sea cada día mejor. Esa es nuestra razón de ser y lo que en realidad mejor sabemos hacer.

Water is life. Just seeing and hearing it increases the blood flow in the brain and heart, and relaxes us.

At Genebre, we know the great variety of benefits that only water can offer. That's why we continue improving our products so that your experience with water is better every day. That is our reason for being and what we really know best how to do.

GENEBRE

Feel the quality



En Genebre podríamos hablarte de los rigurosos exámenes que organismos de certificación independientes han realizado a todos nuestros productos (laboratorios ENAC, laboratorio Oliver Rodés, WRAS, ACS).

También podríamos aburrirte enumerando las complejas normativas que cumple nuestra empresa (la ISO 9001, la ISO 14001) o nuestros productos (la UNE-EN 19703, la EN 1982, la CW617N, la EN 12165, la ISO 9227, la EN 200, la NF 077, la EN1717, ...).

O maravillarte con las numerosas pruebas de resistencia a las que sometemos a nuestros productos antes de que salgan al mercado (discos cerámicos capaces de resistir más de 200.000 maniobras, giro de los caños que después de más de 80.000 accionados siguen como el primer día, cromados resistentes a la corrosión, plásticos anticálcareos, el latón y sus aleaciones, etc...).

Pero por encima de todo, queremos hablarte de nuestro compromiso con la calidad y la salud, del ahorro de agua y energía o de la garantía y la asistencia técnica con la que nos encontrarás siempre a tu lado.

Homologación CE (cuando es requerido) y otras específicas para mercados como Bielorrusia, Chile, Polonia, Rusia, México, Ucrania, Singapur y Arabia Saudí.

GENEBRE es miembro de Agrival, Asociación nacional de fabricantes de grifería y valvulería.

At Genebre we could tell you about the rigorous examinations that independent certification institutions have carried out on our products (ENAC laboratories, Oliver Rodés laboratory, WRAS, ACS).

We could also bore you just by listing the large list of regulations that our company complies with (ISO 9001, ISO 14001) or our products (UNE-EN 19703, EN 1982, CW617N, EN 12165, ISO 9227, EN 200, NF 077, EN1717, ...).

Or marvel you with the numerous resistance tests that we always undergo internally to our products before they are launched on the market (ceramic discs capable of withstanding more than 200,000 maneuvers, turning of the pipes that after more than 80,000 actuation continue as the first day, corrosion-resistant chrome plating, anti-limescale plastics, brass and its alloys, etc ...

But above all, we want to talk to you about our commitment to quality and health, saving water and energy or the guarantee and technical assistance with which you will always find us by your side.

EC homologation (when required) and other specific certifications for markets in Belarus, Chile, Poland, Russia, Mexico, Ukraine, Singapore and Saudi Arabia.

GENEBRE is a member of Agrival, the national association of taps and valve manufacturers.

Grifería diseñada para edificios sostenibles

En GENE BRE desarrollamos productos pensados para mejorar el nivel de sostenibilidad de edificios y el confort de las personas, para que arquitectos, ingenieros y, en general, cualquier profesional de la construcción, puedan desarrollar sus proyectos de edificios sostenibles, saludables, respetuosos con el medio ambiente y que cumplan con la normativa vigente.

Taps designed for sustainable buildings

At GENE BRE we develop products that improve the level of sustainability of buildings and the comfort of people, so that architects, engineers and, in general, any construction professional, can develop their projects of sustainable, healthy, environmentally friendly buildings and that comply with current regulations.

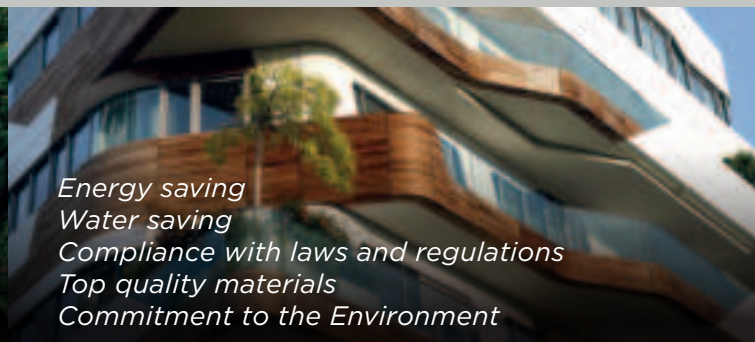



La grifería GENE BRE ayuda a cumplir y mejorar las certificaciones:

GENE BRE taps help to comply and improve the certifications:

Certificación LEED (America) para la eficiencia con el consumo de agua, limitando el consumo máximo de litros por minuto o de litros por uso en el caso de temporizados.



LEED certification (America) for efficiency with water consumption, limiting the maximum consumption of liters per minute or liters per use in the case of timer.

Certificación DGNB (Alemania) para la evaluación y certificación de la sostenibilidad, que contempla aspectos medioambientales, económicos y socio-culturales de los edificios.

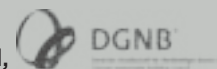

DGNB certification (Germany) for the evaluation and certification of sustainability, which considers environmental, economic and socio-cultural aspects of buildings.

Certificación BREEAM (Inglaterra) para la evaluación y certificación de la sostenibilidad en la edificación que actualmente ya cuenta con 600.000 edificios certificados en más de 90 países.



BREEAM certification (England) for the evaluation and certification of sustainability in buildings, which currently has 600,000 certified buildings in more than 90 countries.

La Certificación Edificio Sustentable (CES, Chile) para incentivar el diseño y la construcción de edificios con criterios de sustentabilidad y estimular el mercado para que valore este tipo de edificaciones.



The Sustainable Building Certification (CES, Chile) to encourage the design and construction of buildings with sustainability criteria and stimulate the market to value this type of buildings.

Certificación WELL sistema de puntuación dinámico para edificios y comunidades que permite identificar, medir y monitorizar las características de los espacios construidos que impactan en la salud y el bienestar de los ocupantes.



WELL certification, a dynamic scoring system for buildings and communities that allows to identify, measure and monitor the characteristics of the built spaces that impact on the health and well-being of the occupants

Certificación de Sustentabilidad (CS, Argentina) para dar visibilidad a las acciones relacionadas con el cuidado del Medio Ambiente y la Responsabilidad Social Empresarial.



Sustainability Certification (CS, Argentina) to give visibility to actions related to caring for the Environment and Corporate Social Responsibility.

Certificación Verde España: sistema de evaluación y certificación de la sostenibilidad. Un evaluador acreditado realiza la evaluación con la herramienta VERDE como paso previo a la certificación del edificio.



Green Spain Certification: sustainability evaluation and certification system. An accredited evaluator performs the evaluation with the GREEN tool as a preliminary step to the certification of the building.

Porque un edificio sostenible es el que funciona bien hoy y en el futuro.

Because a sustainable building is one that works well today and in the future.

Si tienes dudas o consultas, ponte en contacto con nuestro Departamento de Proyectos donde analizaremos tu caso en concreto y te ofreceremos un asesoramiento personalizado.

If you have questions or queries, get in touch with our Projects Department where we will analyze your specific case and offer you personalized advice.





Más opciones ecológicas

More green options

Presentamos los sistemas que incorporan las diferentes griferías de GENE BRE para ahorrar en el gasto de agua y energía.

Novedades diseñadas especialmente para facilitar el uso y, a su vez, hacerlo más seguro y medioambientalmente sostenible.

Promoviendo la sensibilidad y el respeto por el medioambiente

GENEBRE es una compañía comprometida con el medioambiente. Su visión de un futuro sostenible y una filosofía enfocada en proteger el agua y los fluidos le permiten mejorar, investigar, desarrollar y crear conceptos innovadores a partir de las tecnologías más punteras. De manera que aplica siempre criterios que transmitan valores ecológicos en todos sus productos y a la vez que satisfagan las necesidades de funcionalidad, confort y diseño de los usuarios.

GENEBRE ha colaborado en el programa de I+D NUESVAL. Un estudio coordinado por el Centro Tecnológico de Manresa cuyo objetivo es desarrollar nuevas aleaciones de latón para válvulas de conducción de fluidos en condiciones ambientales de alta temperatura. Un modelo de proyecto basado en la innovación, en el que GENE BRE ha depositado su compromiso empresarial, con el fin de desarrollar tipos específicos de válvulas destinadas tanto a instalaciones domésticas como industriales..

The following user-friendly systems include the different GENE BRE taps that make for safer and more environmentally sustainable use, leading to financial savings in water expenditure and/or domestic energy.

Promoting respect for the environment

GENEBRE is a company committed to the environment. Its vision of a sustainable future and a philosophy focused on protecting water and fluids allow it to improve, research, develop and create innovative concepts using the most advanced technologies. GENE BRE always applies the same criteria which transmits ecological values in all of its products, and at the same time satisfies the users' needs of functionality, comfort, and design.

GENEBRE has collaborated el programa de I+D NUESVAL, a study coordinated by the Centro Tecnológico de Manresa, whose objective is to develop new brass and bronze alloy for valves. It is a project model based on innovation, in which GENE BRE reinforces its commitment to developing specific types of valves for domestic as well as industrial installations.

Ahorro de agua *Water saving*
Ahorro energético *Energy saving*
Medio ambiente *Environment*
Sostenibilidad *Sustainability*



Sistema GE-ECO.
 En las series Koral, Kode,
 Klip, Kelogic, Tau y Oslo.

GE-ECO system.
In Koral, Kode, Klip, Kelogic,
Tau and Oslo series.



Sistema GE-COLD START.
 En las series Kelogic, Tau
 y Oslo.

GE-COLD START.
In Kelogic, Tau y Oslo series.

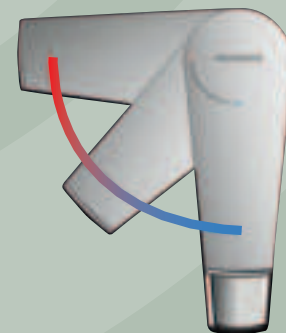

Gran variedad de economizadores.

A wide range of economizers.



Sistemas de filtrado.
 En las serie Tau Cocinas.

Filtration systems.
In Tau Kitchen serie.



GENEBRE

Tecnología

Technology

Presentamos los sistemas que incorporan las diferentes griferías de GENE BRE para ahorrar en el gasto de agua y energía.

Novedades diseñadas especialmente para facilitar el uso y, a su vez, hacerlo más seguro y medioambientalmente sostenible.

The following user-friendly systems include the different GENE BRE taps that make for safer and more environmentally sustainable use, leading to financial savings in water expenditure and/or domestic energy.



GE-ECO

- **Economizador de agua.**
- **Ahorro de energía.**
- *Water economizer.*
- *Energy saving.*



GE-2P

Apertura del grifo en dos posiciones:

- Primera posición: **ahorro del 50% de agua.**
- Segunda posición: pleno caudal.

Two-position opening of the tap:

- First position: **supplies 50% less water.**
- Second position: full flow.

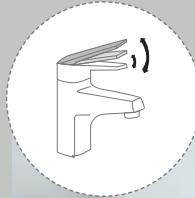

Innovo



GE-COLD START

- **Gran ahorro energético:**

Descubre todos los nuevos productos con tecnología GE-COLD START, podrás identificarlo con el icono superior en cada producto.

- **Great deal of energy:**

prevents boiler, heater or electric boiler from being activated unduly.

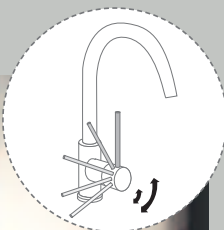

Ref. 65219 18 45 66



GE-SAFE

- **Prevención ante quemaduras:**

limita a 38°C el caudal de agua caliente, y asegura el corte de agua para evitar quemaduras en caso de fallo del suministro de agua fría.

- **Prevention against burns:**

limits and ensures hot water cuts off at a maximum temperature of 38°C, avoiding burns in the event of a cut in the cold-water supply.

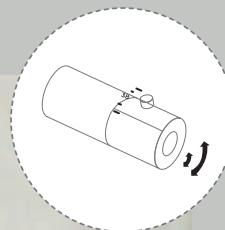

Ref.: 67112 14 45 67

GENEBRE

Novedades

News

2024

NEW

- 1 Nueva Serie Kloe versátil y estilizada, disponible con los nuevos acabados Brushed Metal y Gold.
- 2 Nuevos acabados Black en serie Koral.
- 3 Nuevos accesorios para baño en los nuevos acabados Brushed Metal y Gold.
- 4 Nueva grifería empotrada para ducha GEBOX con sistema premontado
- 5 Nuevos accesorios para mayor modularidad en grifería empotrada para ducha.
- 6 Nueva sección de Ayudas Técnicas a la Instalación.

- 1 *New versatile and stylish Kloe Series, available with the new Brushed Metal and Gold finishes.*
- 2 *New Black finishes in series such as Koral.*
- 3 *New bathroom accessories in the new Brushed Metal and Gold finishes.*
- 4 *New GEBOX built-in shower taps with pre-assembled system*
- 5 *New accessories for greater modularity in built-in shower taps.*
- 6 *New section of Technical Installation Aids.*



Brushed
Gold



Black



1 3

Nueva Serie de grifería
para Baño KLOE y nuevos
acabados en accesorios

*New Bathroom Taps KLOE
Series and new finishes
in accessories*

Chrome



Brushed
Metal



Nueva estructura New structure

Nueva presentación de acabados de
producto, agrupados por referencias.
Además, podrás acceder a la
información técnica a través del QR.

*New presentation of product finishes,
grouped by references. In addition,
you can access technical information
through the QR.*

Acabados Finishes



Chrome

Black

Brushed
Gold

Brushed
Metal



Monomando de ducha empotrado
Built-in single lever shower mixer

● Ref.: 69115 34 45 66 - **Chrome**

● Ref.: 69115 34 41 66 - **Black**

● Ref.: 69115 34 51 66 - **Brushed Gold**

● Ref.: 69115 34 52 66 - **Brushed Metal**



Consulta las especificaciones técnicas
de los productos escaneando el QR
Check the technical specifications
of the products by scanning the QR



GENEBRE

Acabados

Finishes

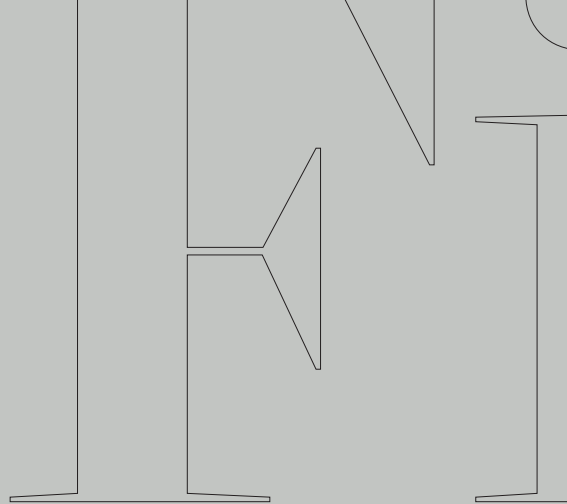

Amisno



Chrome



Black



Brushed Gold

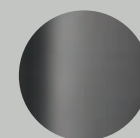

Brushed Gold

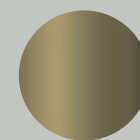

Bronze



White



Inox

GENEBRE

Medidas

Measures

Porque cada baño es distinto y personal, en Genebre ponemos a tu disposición diferentes alturas en todos nuestros grifos de las colecciones Kode, Oslo, Tau, Tau2, Koral, Klip, Klip2, Kelogic, Kenjo y K8, fabricadas siempre de una sola pieza, aportando un plus de diseño y robustez.

Tú eliges. La altura convencional de toda la vida para lavarse las manos, o una altura media, alta, empotrada o de pie con los que también podrás llenar recipientes, lavarte el pelo o darle a tu baño ese toque de diseño que estabas buscando.

Because each bathroom is different and personal, at Genebre we offer you different heights in all our taps from the Kode, Oslo, Tau, Tau2, Koral, Klip, Klip2, Kelogic, Kenjo and K8 collections, all of them manufactured in one piece providing a plus of design and robustness.

It's your choice. The conventional height to wash your hands, or a medium, high, recessed or standing height with which you can also fill containers, wash your hair or give your bathroom that touch of design that you were looking for.

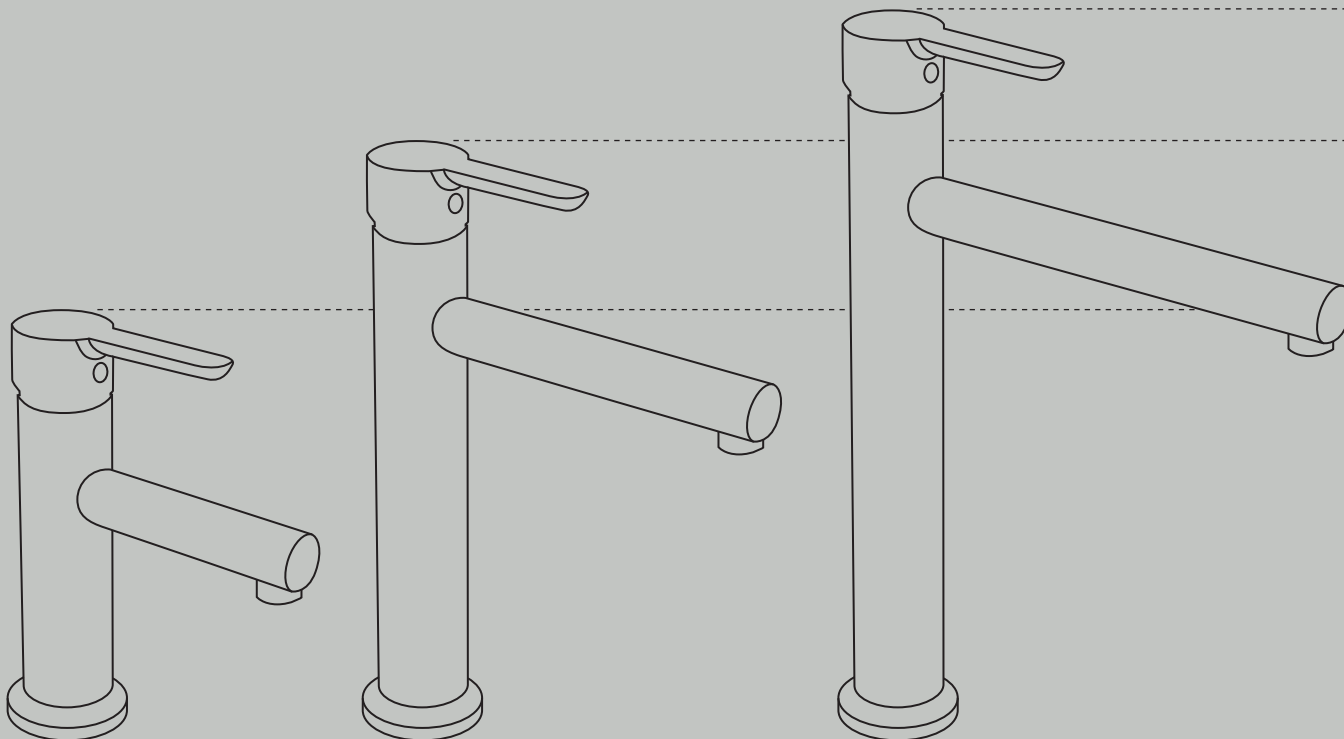

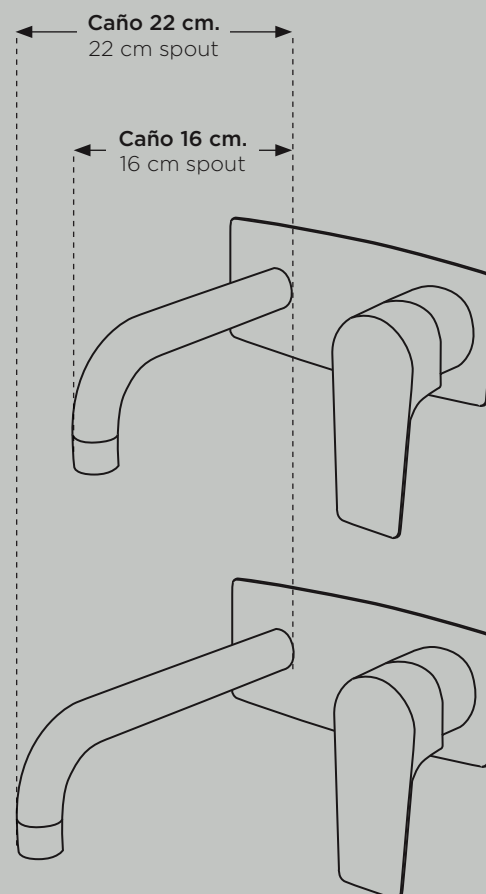
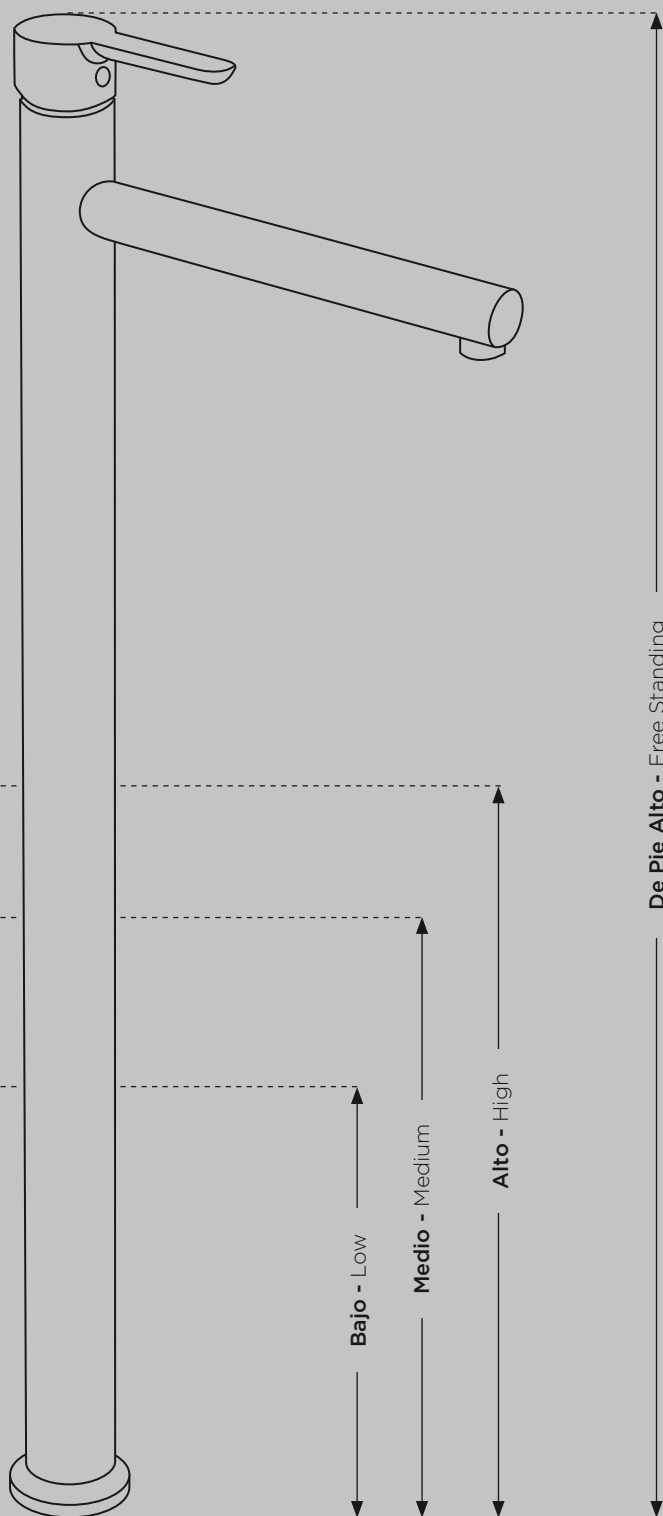

Genebre: soluciones a medida y máximo confort para cada lavabo, ya sea empotrado, sobre encimera, normal o tipo bol.

Genebre: tailor-made solutions and maximum comfort for each washbasin, whether built-in, countertop, normal or bowl-type.

DB

Baños

Bathrooms

El agua es vida. Sólo con verla y oírla, aumenta el flujo sanguíneo en el cerebro y el corazón, y nos relaja.

En Genebre sabemos la gran variedad de beneficios que sólo el agua puede ofrecer. Por eso seguimos mejorando continuamente nuestros productos para que tu experiencia con el agua sea cada día mejor. Esa es nuestra razón de ser y lo que en realidad mejor sabemos hacer.

Water is life. Just seeing and hearing it increases the blood flow in the brain and heart, and relaxes us.

At Genebre, we know the great variety of benefits that only water can offer. That's why we continue improving our products so that your experience with water is better every day. That is our reason for being and what we really know best how to do.



Kloe

Un mundo de acabados / A world of finishes

La nueva serie Kloe reafirma el concepto de estilo y elegancia, con un diseño único, puro y estilizado. Además, se adapta perfectamente a todo tipo de espacios de baño, gracias a su incomparable versatilidad y una amplia gama de acabados.

The new Kloe series reaffirms the concept of style and elegance, with a pure and stylized design. In addition, it adapts perfectly to all types of bathroom spaces, thanks to its incomparable versatility and a wide range of finishes.

Monomandos Lavabo
Single lever wash-basin mixers



Kloe

Acabados Finishes



Consulta las especificaciones técnicas de los productos escaneando el QR
Check the technical specifications of the products by scanning the QR



Monomando de lavabo

Single lever wash-basin mixer

- Ref.: 69130 34 45 66 - **Chrome**
- Ref.: 69130 34 41 66 - **Black**
- Ref.: 69130 34 51 66 - **Brushed Gold**
- Ref.: 69130 34 52 66 - **Brushed Metal**

Monomando de lavabo medio alto

Medium height single lever wash-basin mixer

- Ref.: 69134 34 45 66 - **Chrome**
- Ref.: 69134 34 41 66 - **Black**
- Ref.: 69134 34 51 66 - **Brushed Gold**
- Ref.: 69134 34 52 66 - **Brushed Metal**

Monomando de lavabo alto

High single lever wash-basin mixer

- Ref.: 69136 34 45 66 - **Chrome**
- Ref.: 69136 34 41 66 - **Black**
- Ref.: 69136 34 51 66 - **Brushed Gold**
- Ref.: 69136 34 52 66 - **Brushed Metal**

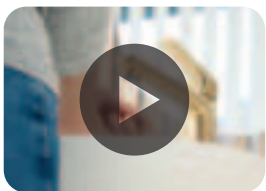

¡Enlaza al video y déjate inspirar con nuestra nueva serie Kloe para baños!

Link to the video and be inspired by our new Kloe series for bathrooms!

Acabados Finishes



Chrome



Black



Brushed
Gold



Brushed
Metal



Monomando de lavabo empotrado caño 16 cm
Built-in wash-basin mixer 16 cm spout

- Ref.: 69131 34 45 66 - **Chrome**
- Ref.: 69131 34 41 66 - **Black**
- Ref.: 69131 34 51 66 - **Brushed Gold**
- Ref.: 69131 34 52 66 - **Brushed Metal**



Monomando de lavabo empotrado caño 22 cm
Built-in wash-basin mixer 22 cm spout

- Ref.: 69132 34 45 66 - **Chrome**
- Ref.: 69132 34 41 66 - **Black**
- Ref.: 69132 34 51 66 - **Brushed Gold**
- Ref.: 69132 34 52 66 - **Brushed Metal**



Monomando de bidé
Single lever bidet mixer

- Ref.: 69140 34 45 66 - **Chrome**
- Ref.: 69140 34 41 66 - **Black**
- Ref.: 69140 34 51 66 - **Brushed Gold**
- Ref.: 69140 34 52 66 - **Brushed Metal**



Monomando de bidé con transmisión
Single lever bidet mixer with diverter

- Ref.: 69142 34 45 66 - **Chrome**
- Ref.: 69142 34 41 66 - **Black**
- Ref.: 69142 34 51 66 - **Brushed Gold**
- Ref.: 69142 34 52 66 - **Brushed Metal**

Monomandos Empotrados para Lavabo
Built-in wash-basin mixers



Monomandos Empotrados para Ducha
Single lever shower mixers

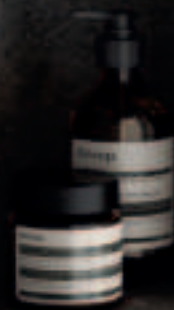

Acabados *Finishes*



Monomando de baño con kit
Single lever bath mixer with kit

- Ref.: 69100 34 45 66 - **Chrome**
- Ref.: 69100 34 41 66 - **Black**
- Ref.: 69100 34 51 66 - **Brushed Gold**
- Ref.: 69100 34 52 66 - **Brushed Metal**

Monomando de ducha con kit
Single lever shower mixer with kit

- Ref.: 69110 34 45 66 - **Chrome**
- Ref.: 69110 34 41 66 - **Black**
- Ref.: 69110 34 51 66 - **Brushed Gold**
- Ref.: 69110 34 52 66 - **Brushed Metal**



Monomando de ducha empotrado
Built-in single lever shower mixer

- Ref.: 69115 34 45 66 - **Chrome**
- Ref.: 69115 34 41 66 - **Black**
- Ref.: 69115 34 51 66 - **Brushed Gold**
- Ref.: 69115 34 52 66 - **Brushed Metal**

Monomando empotrado con inversor 2 vías
2 way Built-in single lever mixer with diverter

- Ref.: 69116 34 45 66 - **Chrome**
- Ref.: 69116 34 41 66 - **Black**
- Ref.: 69116 34 51 66 - **Brushed Gold**
- Ref.: 69116 34 52 66 - **Brushed Metal**



Koral

Relájate / Relax

Siente tu respiración. Deja que el agua acaricie todos tus poros, y disfruta de las sinuosas líneas y el estilo propio de la nueva Serie Koral.

Feel your breath. Let the water caress all your pores, and enjoy the sinuous lines of the new Koral Series.

Koral

Acabados Finishes

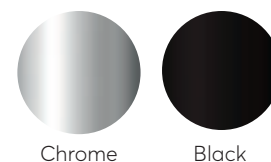

Chrome



Black

Consulta las especificaciones técnicas de los productos escaneando el QR
Check the technical specifications of the products by scanning the QR



Monomando de lavabo
Single lever wash-basin mixer

- Ref.: 64130 32 45 66 - **Chrome**
- Ref.: 64130 32 41 66 - **Black**



Monomando de lavabo medio alto
Medium height single lever wash-basin mixer

- Ref.: 64134 32 45 66 - **Chrome**
- Ref.: 64134 32 41 66 - **Black**



Monomando de lavabo alto
High single lever wash-basin mixer

- Ref.: 64136 32 45 66 - **Chrome**
- Ref.: 64136 32 41 66 - **Black**

Monomando de lavabo apertura en frío
Single lever wash-basin mixer cold start

- Ref.: 64150 32 45 - **Chrome**

Monomandos de Lavabo
Wash-basin mixers



Ref.: 64130 32 41 66

Monomandos de Lavabo Empotrados
Built-in wash-basin Mixers



Acabados *Finishes*



Monomando de lavabo empotrado caño 16 cm
Built-in wash-basin mixer 16 cm spout

- Ref.: 64131 32 45 66 - **Chrome**
- Ref.: 64131 32 41 66 - **Black**

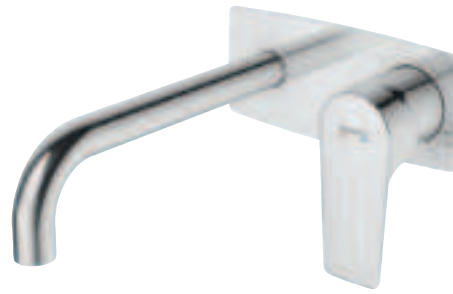

Monomando de lavabo empotrado caño 22 cm
Built-in wash-basin mixer 22 cm spout

- Ref.: 64132 32 45 66 - **Chrome**
- Ref.: 64132 32 41 66 - **Black**



Monomando de bidé
Single lever bidet mixer

- Ref.: 64140 32 45 66 - **Chrome**
- Ref.: 64140 32 41 66 - **Black**



Monomando de bidé con transmisión
Single lever bidet mixer with diverter

- Ref.: 64142 32 45 66 - **Chrome**
- Ref.: 64142 32 41 66 - **Black**



Monomando de ducha con kit
Single lever shower mixer with kit

- Ref.: 64110 32 45 66 - **Chrome**
- Ref.: 64110 32 41 66 - **Black**



Monomando de baño con kit
Single lever bath mixer with kit

- Ref.: 64100 32 45 66 - **Chrome**
- Ref.: 64100 32 41 66 - **Black**



* **Kit incluido**

* **Kit included**

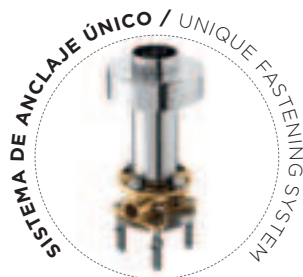

Se crean 5 variantes de monomando para bañera exenta, y un juego de columnas equipables con la grifería a escoger. Todas las variantes poseen un sistema de regulación único, el cuál nos ayudará a instalarlo totalmente perpendicular y alineado perfectamente con la bañera.

5 variants of single-lever bath for exempt bathtub are created, and a set of columns that can be equipped with the taps to be selected. All the variants have a unique regulation system, which will help us to install it completely perpendicular and perfectly aligned with the bathtub.



Monomando de pie para bañera
Floor single lever mixer for bath

● Ref.: 64119 32 45 66 - **Chrome**

● Ref.: 64119 32 41 66 - **Black**

Monomando de Pie para Bañera Floor Single-lever Mixer for Bath

Ref.: 64119 32 41 66

Acabados *Finishes*



Monomando de ducha empotrado
Built-in single lever shower mixer

- Ref.: 64115 32 45 66 - **Chrome**
- Ref.: 64115 32 41 66 - **Black**



Monomando empotrado con inversor 2 vías
2 way Built-in single lever mixer with diverter

- Ref.: 64116 32 45 66 - **Chrome**
- Ref.: 64116 32 41 66 - **Black**



Monomando 2 vías empotrado
2 way Built-in single lever mixer

- Ref.: 64316 32 45 66 - **Chrome**
- Ref.: 64316 32 41 66 - **Black**



¡Enlaza al video y conoce mejor nuestro sistema GEBOX!

Link to the video and learn about our GEBOX system!



Monomando empotrado con inversor cerámico 2 vías

Built-in single lever mixer with 2-way ceramic diverter

- Ref.: 64117 32 45 66 - **Chrome**
- Ref.: 64117 32 41 66 - **Black**



Monomando empotrado con inversor cerámico 3 vías

Built-in single lever mixer with 3-way ceramic diverter

- Ref.: 64118 32 45 66 - **Chrome**
- Ref.: 64118 32 41 66 - **Black**



Inversor cerámico 3 vías empotrado
Built-in 3-way ceramic diverter

- Ref.: 64114 30 45 66 - **Chrome**
- Ref.: 64114 30 41 66 - **Black**

Acabados Finishes



Chrome



Black

GE-EASY: UNIC Control



Un innovador concepto de columna de ducha extensible que incorpora un sistema de doble función en la maneta, desde donde accionar el rociador o el mango de ducha.

An innovative concept of extendable shower column that incorporate a dual function system in the actuator from which to operate the shower head or shower handle.

UNIC Control:
Temperatura. Temperature.
Caudal. Flow.
Inversor. Inverter.

- A** **Función rociador.**
Shower head function.
- C** **Función mango de ducha.**
Handshower function.
Stop.

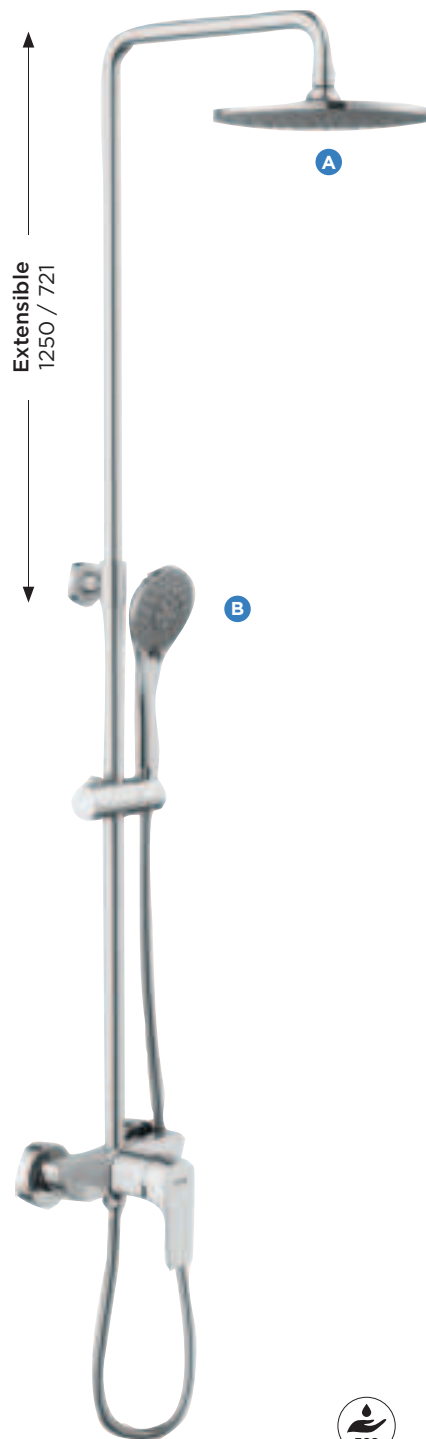

Columna monomando extensible con kit
 Single lever extendable column with kit

- Ref.: CM64110 32 - **Chrome**
- Ref.: CM64111 32 41 - **Black**



Columna Monomando Extensible con Kit
Single Lever Extensible Column eith Kit



Oslo

Vanguardismo y sencillez Vanguardism and simplicity

Una línea estilizada de formas depuradas y ángulos rectos es la base de la serie Oslo. Una nueva colección con diferentes alturas de caños, que proyecta elegancia y esbeltez y un avanzado diseño vanguardista donde cada detalle está pensado para embellecer el baño.

A stylized line of pure forms and right angles is the basis of the Oslo series. A new collection, with different spout heights, which projects elegance and slenderness, and has an advanced vanguardist design where each detail is intended to beautify the bathroom.

Oslo

Acabados Finishes



Chrome



Black

Consulta las especificaciones técnicas de los productos escaneando el QR
Check the technical specifications of the products by scanning the QR



Monomando de lavabo

Single lever wash-basin mixer

● Ref.: 65130 19 45 66 - **Chrome**

● Ref.: 65130 19 45 66 - **Black**



Monomando de lavabo medio alto

Medium height single lever wash-basin mixer

● Ref.: 65134 19 45 66 - **Chrome**

● Ref.: 65134 19 41 66 - **Black**



Monomando de lavabo alto

High single lever wash-basin mixer

● Ref.: 65136 19 45 66 - **Chrome**

● Ref.: 65136 19 41 66 - **Black**



Monomando de lavabo apertura en frío

Single lever wash-basin mixer cold start

● Ref.: 65150 19 45 66 - **Chrome**

Monomando de Lavabo
Wash-basin Mixer



Monomando de Pie para Lavabo
Floor Single-lever Mixer for Basin





La grifería GENE BRE está diseñada y fabricada según los estándares europeos de calidad, como la UNE-EN 19703 ofreciendo la funcionalidad, durabilidad y seguridad esperadas.

GENEBRE taps are designed and manufactured according to European quality standards, such as UNE-EN 19703, offering the expected functionality, durability and safety.



Para una instalación totalmente perpendicular y alineado.

Completely perpendicular and perfectly aligned installation.



NEW

Monomando de Pie para lavabo OSLO
OSLO Floor single lever mixer for basin

- Ref.: 65139 19 45 66 - **Chrome**
- Ref.: 65139 19 41 66 - **Black**

Acabados *Finishes*

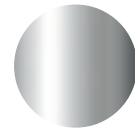

Chrome



Black

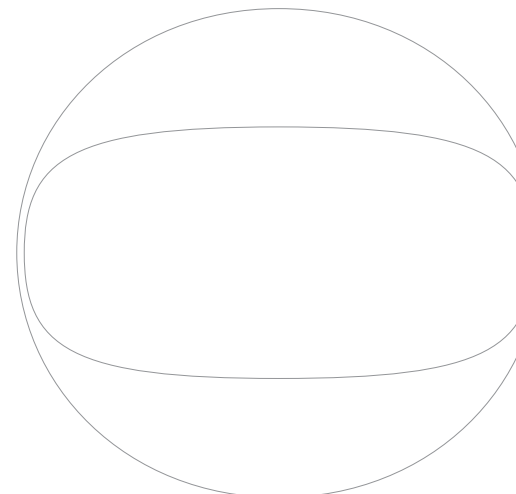
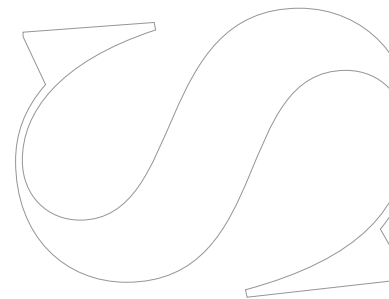
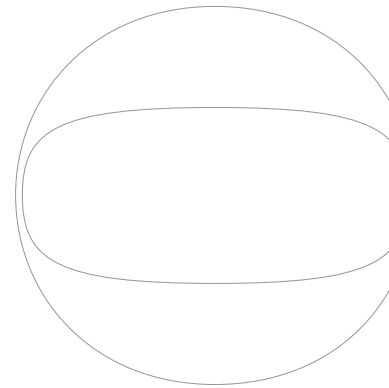

Acabados Finishes



Chrome



Black



NEW

Monomando de lavabo empotrado caño 16 cm
Built-in wash-basin mixer 16 cm spout

● Ref.: 65131 19 45 66 - **Chrome**

● Ref.: 65131 19 41 66 - **Black**



NEW

Monomando de lavabo empotrado caño 22 cm
Built-in wash-basin mixer 22 cm spout

● Ref.: 65132 19 45 66 - **Chrome**

● Ref.: 65132 19 41 66 - **Black**

Monomandos de Lavabo Empotrados
Built-in Wash-basin Mixers



Ref.: 65132 19 45 66



Monomando de bidé
Single lever bidet mixer

● Ref.: 65140 19 45 66 - **Chrome**

● Ref.: 65140 19 41 66 - **Black**



Monomando de bidé con transmisión
Single lever bidet mixer with diverter

● Ref.: 65142 19 45 66 - **Chrome**

● Ref.: 65142 19 41 66 - **Black**



Set mezclador sanitario de ducha con soporte
Sanitary shower mixer with support

● Ref.: 65144 19 45 67 - **Chrome**

● Ref.: 65144 19 41 67 - **Black**



Set mezclador sanitario de ducha con soporte
Sanitary shower mixer set with support

● Ref.: 65144 19 45 66 - **Chrome**



Set mezclador Sanitario
Sanitary Shower Mixer

Ref.: 65144 19 45 66

Acabados Finishes

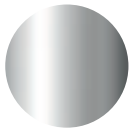

Chrome



Black

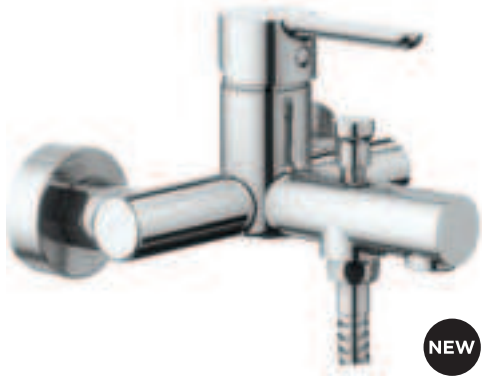

NEW

Monomando de baño con kit
Single lever bath mixer with kit

- Ref.: 65100 19 45 66 - **Chrome**
- Ref.: 65100 19 41 66 - **Black**



NEW

Monomando de ducha con kit
Single lever shower mixer with kit

- Ref.: 65110 19 45 66 - **Chrome**
- Ref.: 65110 19 41 66 - **Black**



Mango de ducha C1 jet
C1 jet handshower

- Ref.: 100197 45 00 - **Chrome**

Flexo H 1/2" - H 1/2" 1,70 m inoxidable
F 1/2" - F 1/2" Stainless steel flexible hose 1.70 m

- Ref.: 100135 60 00 - **Chrome**

Soporte ducha cilíndrico
Cylindrical shower holder

- Ref.: 100153 45 - **Chrome**



NEW

Monomando de ducha empotrado
Built-in single lever shower mixer

- Ref.: 65115 19 45 66 - **Chrome**
- Ref.: 65115 19 41 66 - **Black**

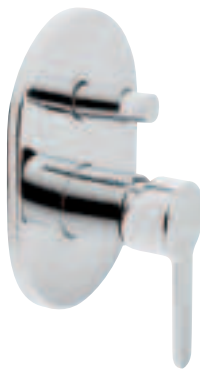

NEW

Monomando empotrado con inversor 2 vías
2 way Built-in single lever mixer with diverter

- Ref.: 65116 19 45 66 - **Chrome**
- Ref.: 69115 19 41 66 - **Black**

OSLO



NEW

Set columna fija con kit
Fixed column set with kit

- Ref.: 1744 45 - **Chrome**
- Ref.: 1744 41 - **Black**



Columna monomando fija con kit
Single lever fixed column with kit

- Ref.: CM65110 19 - **Chrome**
- Ref.: CM65111 19 41 - **Black**



Columna termostática extensible con kit
Thermostatic fixed column with kit

- Ref.: CT67110 1 - **Chrome**
- Ref.: CT67111 19 41 - **Black**

Acabados *Finishes*



Chrome



Black



NEW

Kit de ducha empotrado Oslo

Oslo Built-in shower kit

● Ref.: ST116 19 - **Chrome**

● Ref.: ST1111941 - **Black**

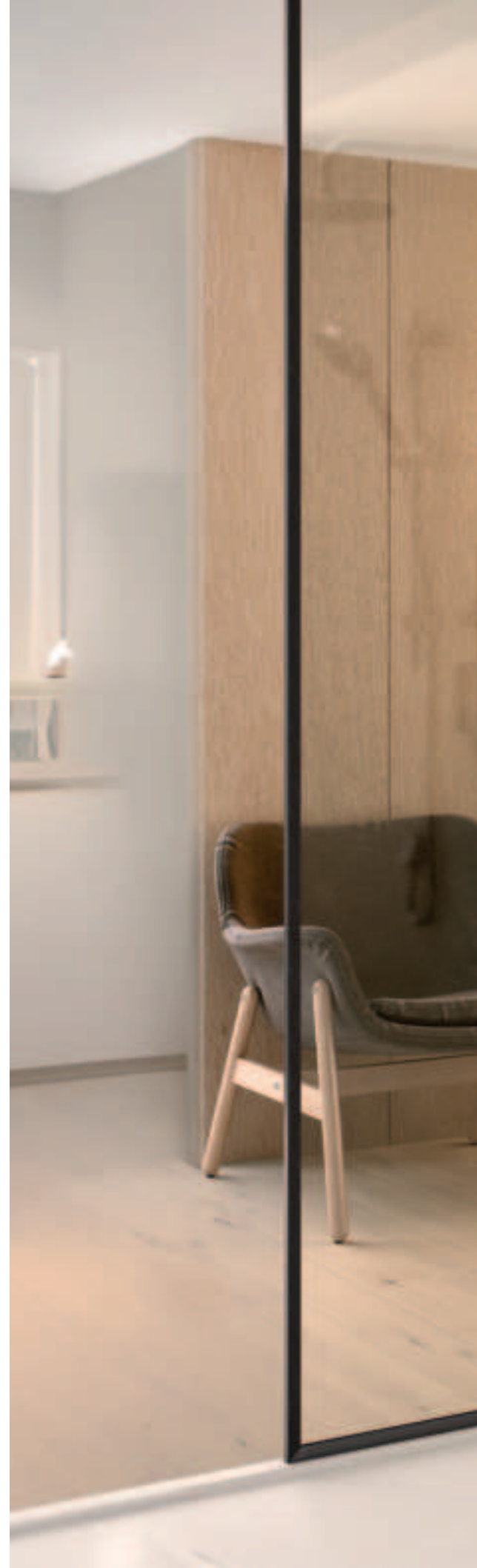



Kit de Ducha Empotrado
Built-in Shower Kit

REF.: ST1111941



Kode

Robustez estilizada / Stylized robustness

Inspirada en las nuevas tendencias, la nueva serie Kode deja entrever un estilo robusto y dinámico de maneta prominente con formas redondeadas que la matizan. Un magnífico diseño de alta gama creada para los baños de última generación.

Inspired in new trends, the new Kode series reveals a robust, dynamic style with a prominent handle with round forms that match. A magnificent high-end design created for new generation bathrooms.

Kode



Consulta las especificaciones técnicas de los productos escaneando el QR
Check the technical specifications of the products by scanning the QR



Chrome



Monomando de lavabo
Single lever wash-basin mixer

● Ref.: 62130 08 45 66 - **Chrome**



Monomando de lavabo alto
High single lever wash-basin mixer

● Ref.: 62136 08 45 66 - **Chrome**

Monomandos de Lavabo
Wash-basin Mixers





**Monomando de lavabo empotrado
caño 16 cm**
Built-in wash-basin mixer
16 cm spout
● Ref.: 62131 31 45 66 - **Chrome**



**Monomando de lavabo empotrado
caño 22 cm**
Built-in wash-basin mixer
22 cm spout
● Ref.: 62132 31 45 66 - **Chrome**



Monomando de bidé
Single lever bidet mixer
● Ref.: 62140 08 45 66 - **Chrome**



Monomando de bidé con transmisión
Single lever bidet mixer with diverter
● Ref.: 62142 31 45 66 - **Chrome**



Monomando de baño sin kit
Single lever bath mixer without kit
● Ref.: 62100 08 45 67 - **Chrome**



Monomando de ducha sin kit
Single lever shower mixer without kit
● Ref.: 62110 31 45 67 - **Chrome**



*** Kit de ducha recomendado:**
* Recommended shower kit:

- Ref.: DXO3 45 - **Chrome**
- Ref.: 100137 60 00 - **Chrome**
- Ref.: 100068 45 - **Chrome**



NEW

Monomando de pie para bañera Kode con sistema de anclaje único
Kode Floor single lever mixer for bath with unique fastening system
● Ref.: 62119 31 45 66 - **Chrome**



Monomandos de Pie
Floor Single Lever

Ref.: 62119 31 45 66



Monomando de ducha empotrado
Built-in single lever shower mixer

● Ref.: 62115 31 45 66 - **Chrome**



Monomando empotrado con inversor cerámico 2 vías
Built-in single lever mixer with 2 way ceramic diverter

● Ref.: 62117 31 45 66 - **Chrome**



Monomando empotrado con inversor cerámico 3 vías
Built-in single lever mixer with 3 way ceramic diverter

● Ref.: 62118 31 45 66 - **Chrome**



Inversor cerámico 3 vías empotrado con placa ovalada
Built-in 3 way ceramic diverter with oval plate

● Ref.: 62114 30 45 66 - **Chrome**

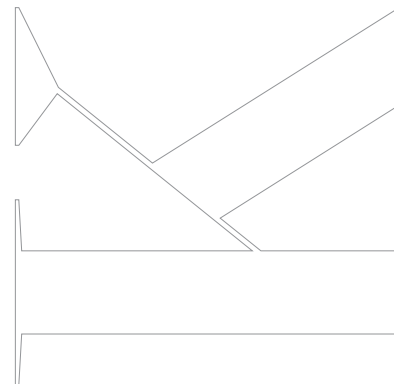
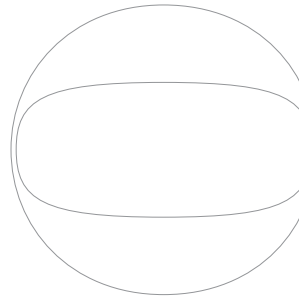
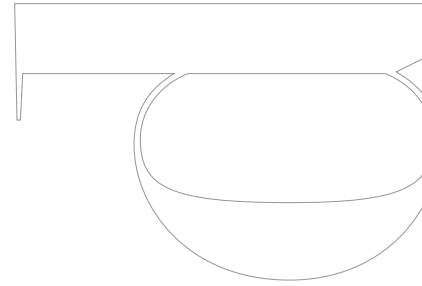
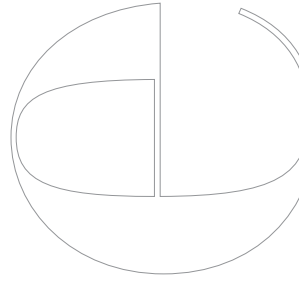

La grifería GENE BRE está diseñada y fabricada según los estándares europeos de calidad, como la UNE-EN 19703 ofreciendo la funcionalidad, durabilidad y seguridad esperadas.

GENEBRE taps are designed and manufactured according to European quality standards, such as UNE-EN 19703, offering the expected functionality, durability and safety.

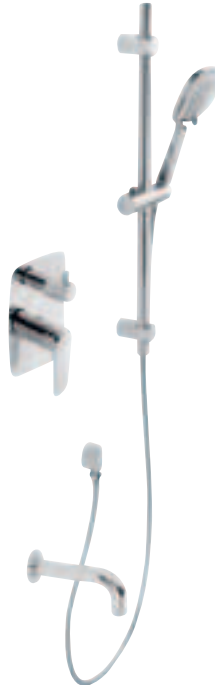

Inversor cerámico 3 vías empotrado con placa ovalada

Built-in 3 way ceramic diverter with oval plate

● Ref.: 62114 30 45 66 - **Chrome**

Monomando de ducha empotrado

Built-in single lever shower mixer

● Ref.: 62115 31 45 66 - **Chrome**

Rociador doble función cascada-lluvia

Shower head double function waterfall-rain

● Ref.: 1643 45 - **Chrome**

Toma ducha mural redonda

Round wall connector

● Ref.: 1680 04 - **Chrome**

Barra ducha TAU

TAU shower bar

● Ref.: 1636 45 - **Chrome**

Flexo extensible

H 1/2" - H 1/2" 1,70 - 2,25 m inoxidable

F 1/2" - F 1/2" Extensible stainless steel flexible hose 1.70 to 2.25 m

● Ref.: 100137 60 00 - **Chrome**

Mango de ducha O3 jets

O3 jets handshower

● Ref.: DXO3 45 - **Chrome**

Monomando empotrado con inversor cerámico 3 vías

Built-in single lever mixer with 3 way ceramic diverter

● Ref.: 62118 31 45 66 - **Chrome**

Brazo pared redondo 35 cm

Round wall arm 35 cm

● Ref.: B65113 18 - **Chrome**

Rociador D22 ovalado

Oval D22 shower sprayer

● Ref.: R63112 08 - **Chrome**

Toma ducha mural redonda

Round wall connector

● Ref.: 1680 04 - **Chrome**

Barra ducha TAU

TAU shower bar

● Ref.: 1636 45 - **Chrome**

Flexo extensible

H 1/2" - H 1/2" 1,70 - 2,25 m inoxidable

F 1/2" - F 1/2" Extensible stainless steel flexible hose 1.70 to 2.25 m

● Ref.: 100137 60 00 - **Chrome**

Mango de ducha O3 jets

O3 jets handshower

● Ref.: DXO3 45 - **Chrome**

Caño mural baño cilíndrico

Round wall bath spout

● Ref.: 1668 45 - **Chrome**

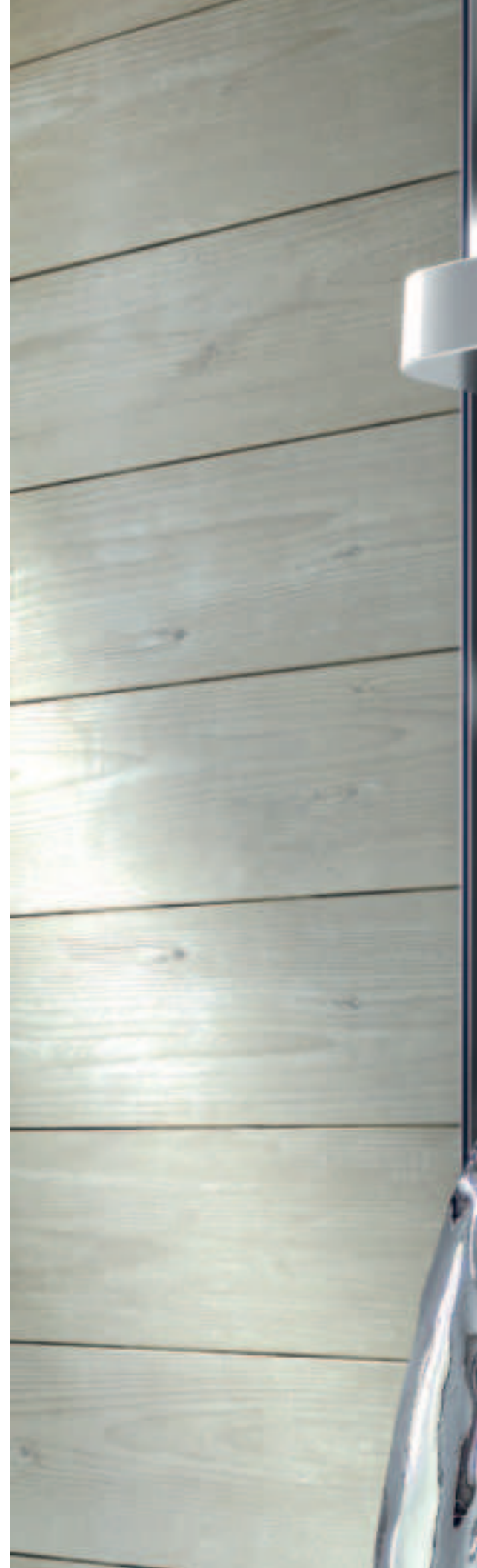





Klip

Siempre actual / Stylized robustness

De líneas rectas y casi cuadradas ofrece un diseño sugerente que se integra con las tendencias de decoración de las cocinas y baños más modernos. Robusta, resistente y de belleza discreta, la colección Klip es una de nuestras colecciones más solicitadas.

Straight, almost square lines offer a suggestive design that combines with the most modern decoration trends for kitchens and bathrooms. Robust, and resistant in its discreet beauty, the Klip series is one of our most sought after collections.

Klip



Consulta las especificaciones técnicas de los productos escaneando el QR
Check the technical specifications of the products by scanning the QR



Chrome



Monomando de lavabo
Single lever wash-basin mixer

● Ref.: 64130 16 45 66 - **Chrome**

Sistema de apertura en frío
Cold start system

● Ref.: 64150 16 45 66 - **Chrome**



Monomando de lavabo medio alto
Medium height single lever wash-basin mixer

● Ref.: 64134 16 45 66 - **Chrome**



Monomando de lavabo alto
High single lever wash-basin mixer

● Ref.: 64136 16 45 66 - **Chrome**

Monomandos de Lavabo
Wash-basin Mixers



Ref.: 64130 16 45 66



Monomando de lavabo empotrado caño 16 cm
Built-in wash-basin mixer 16 cm spout

● Ref.: 64131 16 45 66 - **Chrome**



Monomando de lavabo empotrado caño 22 cm
Built-in wash-basin mixer 22 cm spout

● Ref.: 64132 16 45 66 - **Chrome**



Monomando de bidé
Single lever bidet mixer

● Ref.: 64140 16 45 66 - **Chrome**



Monomando de bidé con transmisión
Single lever bidet mixer with diverter

● Ref.: 64142 16 45 66 - **Chrome**



Monomando de baño con kit *
Single lever bath mixer with kit *

● Ref.: 64100 16 45 66 - **Chrome**



Monomando de ducha con kit *
Single lever shower mixer with kit *

● Ref.: 64110 16 45 66 - **Chrome**



* **Kit incluido**
* Kit included



Monomando de ducha empotrado
Built-in single lever shower mixer

● Ref.: 64115 16 45 66 - **Chrome**



Monomando empotrado con inversor 2 vías
2 way Built-in single lever mixer with diverter

● Ref.: 64116 16 45 66 - **Chrome**



Monomando empotrado con inversor cerámico 2 vías
Built-in single lever mixer with 2-way ceramic diverter

● Ref.: 64117 04 45 66 - **Chrome**



Monomando empotrado con inversor cerámico 3 vías
Built-in single handle mixer with 3-way ceramic diverter

● Ref.: 64118 04 45 66 - **Chrome**



Inversor cerámico 3 vías empotrado con placa cuadrada
Built-in 3-way ceramic diverter with square plate

● Ref.: 65114 30 45 66 - **Chrome**



Termostática baño
Thermostatic bath mixer

● Ref.: 67103 14 45 67 - **Chrome**



Termostática ducha
Thermostatic shower mixer

● Ref.: 67104 14 45 67 - **Chrome**



Monomando empotrado con inversor 2 vías
2 way Built-in single lever mixer with diverter
● Ref.: 64116 16 45 66 - **Chrome**

Brazo a techo redondo 15 cm
Round roof arm 15 cm
● Ref.: 1671 45 - **Chrome**

Rociador redondo 22 cm
Round shower head Ø 22 cm
● Ref.: R65112 18 - **Chrome**

Toma ducha mural redonda
Round wall connector
● Ref.: 1680 04 - **Chrome**

Conjunto Tau, barra, flexo y ducha 5 jets
Tau set, bar, hose and 5 jets handshower
● Ref.: 1748 45 - **Chrome**



Termostática baño
Thermostatic bath mixer
● Ref.: 67103 14 45 67 - **Chrome**

Set columna con ducha, soporte y flexo
Column set with shower, holder and flexible hose
● Ref.: 1745 45 - **Chrome**



La grifería GENE BRE está diseñada y fabricada según los estándares europeos de calidad, como la UNE-EN 19703 ofreciendo la funcionalidad, durabilidad y seguridad esperadas.

GENEBRE taps are designed and manufactured according to European quality standards, such as UNE-EN 19703, offering the expected functionality, durability and safety.

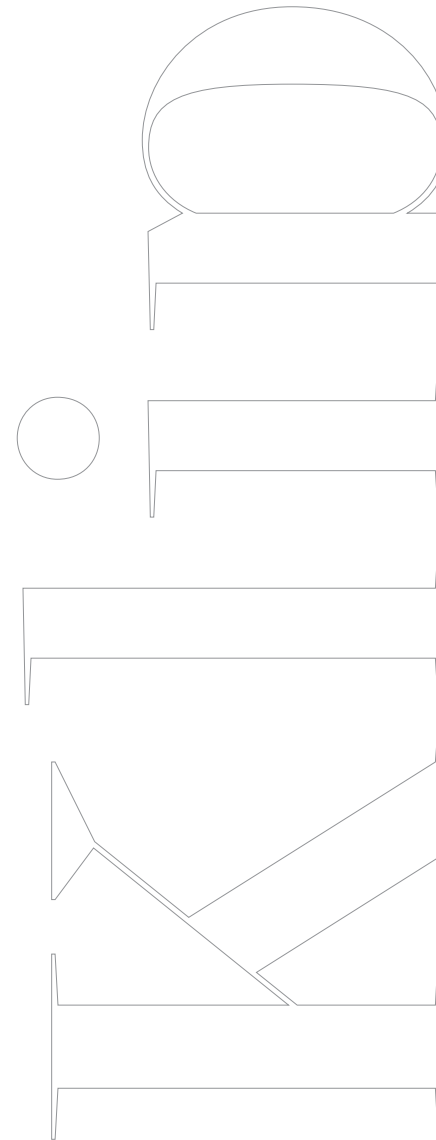



Tau

Espacios con carácter / Spaces with character

Bella y seductora, la serie Tau transforma la cocina y el baño en espacios con estilo. Concebida a partir de un concepto de líneas cilíndricas y curvas estilizadas que realzan su silueta, cuenta con una gran gama de versiones que permiten adaptarla a todos los ambientes.

Beautiful and seductive, the Tau series transforms the kitchen and bathroom into spaces with style. Conceived from cylindrical lines and stylized curves that highlight its silhouette, there is a large variety that adapts to all types of ambiances.

Tau

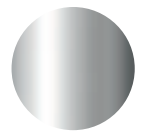

Chrome



Consulta las especificaciones técnicas de los productos escaneando el QR
Check the technical specifications of the products by scanning the QR



Monomando de lavabo
Single lever wash-basin tap
● Ref.: 65135 18 45 66 - **Chrome**



Monomando de lavabo medio alto
Medium height single lever wash-basin mixer
● Ref.: 65134 18 45 66 - **Chrome**



Monomando de lavabo alto
High single lever wash-basin mixer
● Ref.: 65136 18 45 66 - **Chrome**

Monomandos de Lavabo
Wash-basin Mixers

Ref.: 65134 18 54 66





Monomando de lavabo apertura en frío
Single lever wash-basin tap cold start

● Ref.: 65138 18 45 66 - **Chrome**



Monomando de lavabo empotrado caño 16 cm
Built-in wash-basin mixer 16 cm spout

● Ref.: 65131 18 45 66 - **Chrome**



Monomando de lavabo empotrado caño 22 cm
Built-in wash-basin mixer 22 cm spout

● Ref.: 65132 18 45 66 - **Chrome**



Monomando de bidé
Single lever bidet mixer

● Ref.: 65145 18 45 66 - **Chrome**



Monomando de bidé con transmisión
Single lever bidet mixer with diverter

● Ref.: 65142 18 45 66 - **Chrome**



La grifería GENE BRE está diseñada y fabricada según los estándares europeos de calidad, como la UNE-EN 19703 ofreciendo la funcionalidad, durabilidad y seguridad esperadas.

GENEBRE taps are designed and manufactured according to European quality standards, such as UNE-EN 19703, offering the expected functionality, durability and safety.



Monomando de baño con kit *
Single lever bath mixer with kit *
● Ref.: 65100 18 45 66 - **Chrome**



Monomando de ducha con kit *
Single lever shower mixer with kit *
● Ref.: 65110 18 45 66 - **Chrome**



*** Kit incluido**
* Kit included



Monomando de pie para bañera Tau
Tau Floor single lever mixer for bath
● Ref.: 65119 18 45 66 - **Chrome**



NEW

Se crean 5 variantes de monomando para bañera exenta, y un juego de columnas equipables con la grifería a escoger. Todas las variantes poseen un sistema de regulación único, el cuál nos ayudará a instalarlo totalmente perpendicular y alineado perfectamente con la bañera.

5 variants of single-lever bath for exempt bathtub are created, and a set of columns that can be equipped with the taps to be selected. All the variants have a unique regulation system, which will help us to install it completely perpendicular and perfectly aligned with the bathtub.



Set Columna con Ducha, Soporte y Flexo
Column Set with Shower, Holder and Flexible Hose

Tau



Monomando de ducha empotrado
Built-in single lever mixer
● Ref.: 65115 18 45 66 - **Chrome**



Monomando empotrado con inversor 2 vías
2 way Built-in single lever mixer with diverter
● Ref.: 65116 18 45 66 - **Chrome**



Monomando empotrado con inversor cerámico 2 vías
Built-in single lever mixer with 2-way ceramic diverter
● Ref.: 65117 18 45 66 - **Chrome**



Monomando empotrado con inversor cerámico 3 vías
Built-in single lever mixer with 3-way ceramic diverter
● Ref.: 65118 18 45 66 - **Chrome**



Inversor cerámico 3 vías empotrado con placa cuadrada
Built-in 3-way ceramic diverter with square plate
● Ref.: 65114 30 45 66 - **Chrome**

NEW



Termostática baño
Thermostatic bath mixer

● Ref.: 67102 14 45 67 - **Chrome**



Termostática ducha
Thermostatic shower mixer

● Ref.: 67112 14 45 67 - **Chrome**



Termostática Ducha
Thermostatic Shower Mixer

Ref.: 67112 14 45 67



Termostática empotrada 2 vías
Built-in 2-way thermostatic mixer

● Ref.: 64114 14 45 67 - **Chrome**



Termostática empotrada 3 vías
Built-in 3-way thermostatic

● Ref.: 64111 14 45 67 - **Chrome**



Columna monomando extensible con kit
Single lever extensible column with kit
● Ref.: CM65110 18 - **Chrome**



Columna termostática extensible con kit
Thermostatic extensible column with kit
● Ref.: CT67110 18 - **Chrome**



Set columna con ducha, soporte y flexo
Column set with shower, holder and flexible hose
● Ref.: 1745 45 - **Chrome**



Columna Monomando Extensible con Kit
Single-lever Extensible Column with Kit



Tau 2

Mezcla de formas / Mixture of forms

Una colección con mucha personalidad que se sumerge en el contraste de las formas. El caño cilíndrico que proviene de la serie TAU convive con una maneta de formas totalmente rectas. Una fusión que aporta a esta colección un aire más actual.

A collection with a lot of personality is immersed in the contrast of forms. The cylindric spout that comes from the TAU series co-exists with a handle with totally straight lines. A fusion that contributes an air of modernity to the collection.

Tau 2



Chrome



Consulta las especificaciones técnicas de los productos escaneando el QR
Check the technical specifications of the products by scanning the QR



Monomando de lavabo
Single lever wash-basin mixer

● Ref.: 65135 29 45 66 - **Chrome**



Monomando de lavabo medio alto
Medium height single lever wash-basin mixer

● Ref.: 65134 29 45 66 - **Chrome**



Monomando de lavabo alto
High single lever wash-basin mixer

● Ref.: 65136 29 45 66 - **Chrome**



Monomando de lavabo empotrado caño 16 cm
Built-in wash-basin mixer 16 cm spout

● Ref.: 65131 29 45 66 - **Chrome**



Monomando de lavabo empotrado caño 22 cm
Built-in wash-basin mixer 22 cm spout

● Ref.: 65132 29 45 66 - **Chrome**



La grifería GENE BRE está diseñada y fabricada según los estándares europeos de calidad, como la UNE-EN 19703 ofreciendo la funcionalidad, durabilidad y seguridad esperadas.

GENEBRE taps are designed and manufactured according to European quality standards, such as UNE-EN 19703, offering the expected functionality, durability and safety.



Monomando de bidé
Single lever bidet mixer

● Ref.: 65145 29 45 66 - **Chrome**



Monomando de bidé con transmisión
Single lever bidet mixer with diverter

● Ref.: 65142 29 45 66 - **Chrome**



Monomando de baño con kit *
Single lever bath mixer with kit *

● Ref.: 65100 29 45 66 - **Chrome**



Monomando de ducha con kit *
Single lever shower mixer with kit *

● Ref.: 65110 29 45 66 - **Chrome**



*** Kit incluido**
* Kit included

MINA



Monomando de ducha empotrado
Built-in single lever shower mixer
● Ref.: 65115 29 45 66 - **Chrome**



Monomando empotrado con inversor 2 vías
2 way Built-in single lever mixer with diverter
● Ref.: 65116 29 45 66 - **Chrome**



Monomando de pie para bañera Tau 2
Tau 2 Floor single lever mixer for bath
● Ref.: 65119 29 45 66 - **Chrome**



Se crean 5 variantes de monomando para bañera exenta, y un juego de columnas equipables con la grifería a escoger. Todas las variantes poseen un sistema de regulación único, el cuál nos ayudará a instalarlo totalmente perpendicular y alineado perfectamente con la bañera.

5 variants of single-lever bath for exempt bathtub are created, and a set of columns that can be equipped with the taps to be selected. All the variants have a unique regulation system, which will help us to install it completely perpendicular and perfectly aligned with the bathtub.

NEW

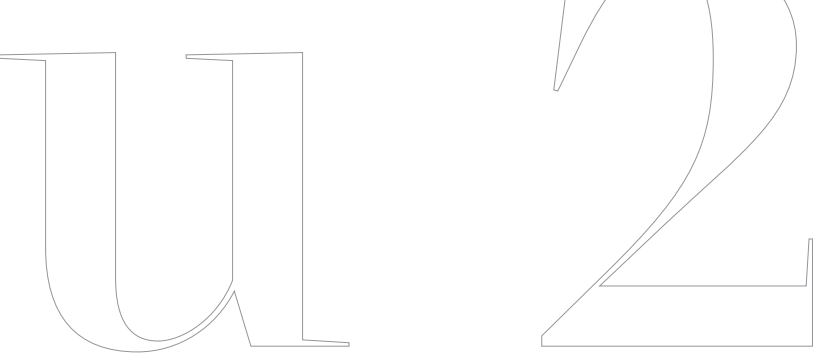

Columna monomando extensible con kit
Single lever extensible column with kit
● Ref.: CM65110 29 - **Chrome**

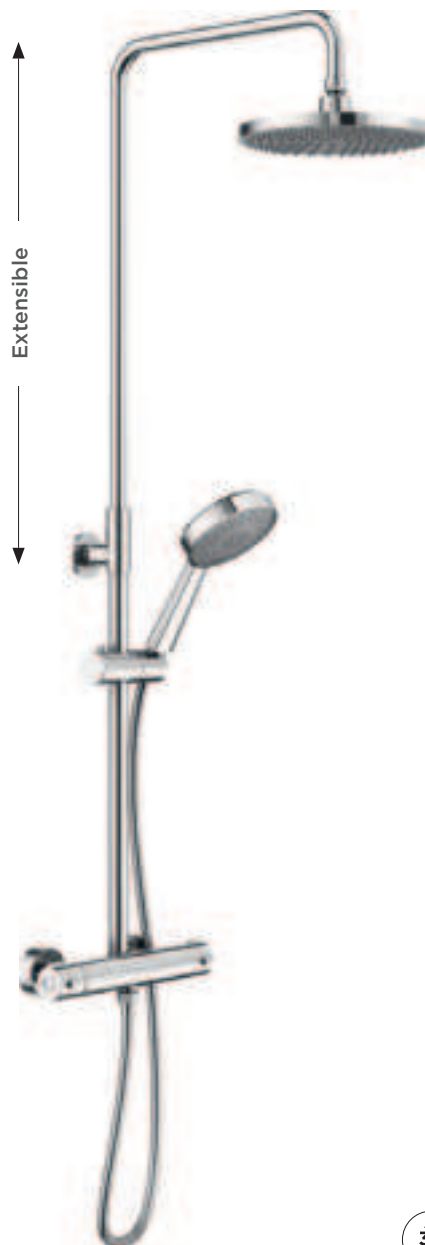

Columna termostática extensible con kit
Thermostatic extensible column with kit
● Ref.: CT67110 18 - **Chrome**



Set columna con ducha, soporte y flexo
Column set with shower, holder and flexible hose
● Ref.: 1745 45 - **Chrome**



Kenjo

**Creada para sentir el placer del agua.
Created to feel the pleasure of water.**

Diseño de gran belleza minimalista, con cuidadas formas rectas y una minuciosa atención a los detalles la convierten en una gama muy especial. Elegante y sobria, pero a la vez espectacular. La salida del agua es libre o tipo cascada que proporciona un chorro limpio y natural para disfrutar de momentos de intenso placer.

A design with great minimalist beauty, careful straight lines, and a meticulous attention to detail make it a very special range. Elegant and simple, yet spectacular at the same time. The water outlet is free or waterfall-style and gives a clean and natural stream to enjoy the pleasures of water.

Kenjo



Consulta las especificaciones técnicas de los productos escaneando el QR
Check the technical specifications of the products by scanning the QR



Chrome



Monomando de lavabo
Single lever wash-basin mixer
● Ref.: 63130 26 45 66 - **Chrome**



Monomando de lavabo medio alto
Medium height single lever wash-basin mixer
● Ref.: 63134 26 45 66 - **Chrome**



Monomando de lavabo alto
High single lever wash-basin mixer
● Ref.: 63136 26 45 66 - **Chrome**



Monomando de lavabo cascada
Waterfall single lever wash-basin mixer
● Ref.: 63137 26 45 66 - **Chrome**



Monomando de lavabo cascada alto
High waterfall single lever wash-basin mixer
● Ref.: 63138 26 45 66 - **Chrome**

Monomando de Lavabo
Wash-basin Mixer



Ref.: 63137 26 45 66



Monomando de lavabo empotrado caño 16 cm
Built-in wash-basin mixer 16 cm spout

● Ref.: 63131 26 45 66 - **Chrome**



Monomando de lavabo empotrado caño 22 cm
Built-in wash-basin mixer 22 cm spout

● Ref.: 63132 26 45 66 - **Chrome**



Monomando de bidé
Single lever bidet mixer

● Ref.: 63140 26 45 66 - **Chrome**



Monomando de bidé con transmisión
Single lever bidet mixer with diverter

● Ref.: 63142 26 45 66 - **Chrome**



Monomando de baño sin kit
Single lever bath mixer without kit

● Ref.: 63100 26 45 67 - **Chrome**



Monomando de ducha sin kit
Single lever shower mixer without kit

● Ref.: 63110 26 45 67 - **Chrome**



*** Kit de ducha recomendado:**
* Recommended shower kit:

Mango de ducha K3 jets
K3 jets handshower
● Ref.: DXK3 45 - **Chrome**

Flexo H 1/2" - H 1/2" 1,70 m inoxidable
F 1/2" - F 1/2" Stainless steel flexible hose 1.70 m
● Ref.: 100135 60 00 - **Chrome**

Soporte ducha Kenjo
Kenjo shower holder
● Ref.: 100149 45 - **Chrome**



Monomando de ducha empotrado
Built-in single lever shower mixer
● Ref.: 63115 26 45 66 - **Chrome**



Monomando empotrado con inversor 2 vías
2 way Built-in single lever mixer with diverter
● Ref.: 63116 26 45 66 - **Chrome**

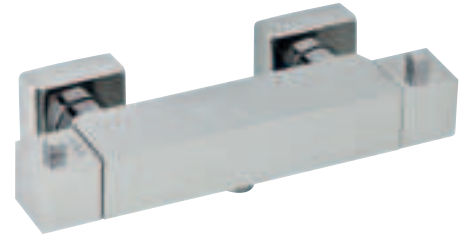

Termostática ducha sin kit
Thermostatic shower mixer without kit
● Ref.: 67110 26 45 67 - **Chrome**



Monomando de pie para bañera Kenjo
Kenjo Floor single lever mixer for bath
● Ref.: 63119 26 45 66 - **Chrome**



Monomando de Pie para Bañera
Single Lever Mixer for Bath

Ref.: 67112 14 45 67

Columna Extensible con Kit
Extensible Column with Kit





Columna monomando extensible con kit
Single lever extensible column with kit
● Ref.: CM63110 26 - **Chrome**



Columna termostática extensible con kit
Thermostatic extensible column with kit
● Ref.: CT67110 26 - **Chrome**



Set columna con ducha, soporte y flexo
Extensible column set with shower, holder and flexible hose
● Ref.: 1746 45 - **Chrome**



K8

La sencillez convertida en diseño / Simply design

A veces, lo más sencillo puede ser inolvidable. Como esta colección de formas discretas y sutiles, combinadas con delicadas líneas curvas y rectas que le confieren una personalidad única y la convierten en la elección ideal para el baño o la cocina.

Sometimes the simplest things can be unforgettable. Like this collection of discreet, subtle forms, combined with delicate curved and straight lines which give it a unique personality and make it the ideal choice for the bathroom and the kitchen.

K8



Chrome



Consulta las especificaciones técnicas de los productos escaneando el QR
Check the technical specifications of the products by scanning the QR



Monomando de lavabo Plus
Single lever wash-basin mixer

● Ref.: 61130 28 45 66 - **Chrome**



Monomando de lavabo medio alto
Medium height single lever wash-basin mixer

● Ref.: 60134 28 45 66 - **Chrome**



Monomando de lavabo alto
High single lever wash-basin mixer

● Ref.: 60136 28 45 66 - **Chrome**

Apertura en frío
Cold start

● Ref.: 61150 28 45 66 - **Chrome**



Monomando de lavabo
Single lever wash-basin mixer

● Ref.: 60150 28 45 66 - **Chrome**



Apertura en frío
Cold start

● Ref.: 60130 28 45 66 - **Chrome**

Apertura en frío
Cold start

● Ref.: 60154 28 45 66 - **Chrome**



Monomando de Lavabo
Single-lever Wash-basin Mixer

Ref.: 60150 28 45 66



Monomando de lavabo centerset 4"
Single lever wash-basin mixer 4" centerset
● Ref.: 60188 28 45 66 - **Chrome**



Monomando de Lavabo
Single-lever Wash-basin Mixer

Ref.: 60188 28 45 66



Monomando de bidé
Single lever bidet mixer
● Ref.: 60140 28 45 66 - **Chrome**



Monomando de bidé con transmisión
Single lever bidet mixer with diverter
● Ref.: 61142 28 45 66 - **Chrome**

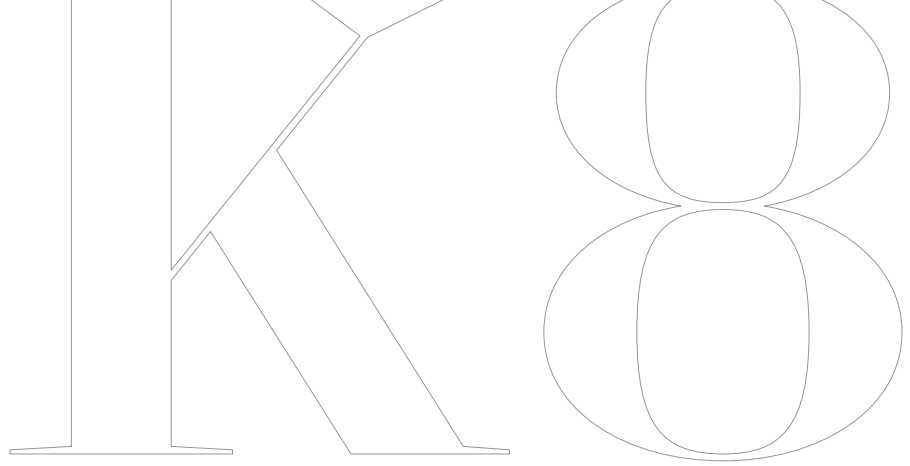

Monomando de baño con kit
Single lever bath mixer with kit
● Ref.: 60100 28 45 66 - **Chrome**



Monomando de ducha con kit
Single lever shower mixer with kit
● Ref.: 60110 28 45 66 - **Chrome**



* **Kit incluido**
* Kit included



Monomando de ducha empotrado
Built-in single lever shower mixer
● Ref.: 61115 28 45 66 - **Chrome**



Monomando empotrado con inversor 2 vías
2 way Built-in single lever mixer with diverter
● Ref.: 61116 28 45 66 - **Chrome**



La grifería GENE BRE está diseñada y fabricada según los estándares europeos de calidad, como la UNE-EN 19703 ofreciendo la funcionalidad, durabilidad y seguridad esperadas.

GENEBRE taps are designed and manufactured according to European quality standards, such as UNE-EN 19703, offering the expected functionality, durability and safety.



Monomando de Baño con Kit
Single Lever Bath Mixer with Kit



Ge2

**La grandeza de lo sencillo.
The greatness of the simple.**

Sencillez y dinamismo, de formas naturales y energicas son los atributos que definen esta sugerente colección. Sus líneas curvas y, a la vez, inclinadas y ergonómicas, su resistencia y su gran fiabilidad le otorgan un aspecto inconfundible.

Simplicity and dynamism, with natural energetic forms, are the attributes that define this suggestive collection. Its curved and ergonomic lines, ireresistance and great reliability give it a striking appearance.

Ge2



Chrome



Consulta las especificaciones técnicas de los productos escaneando el QR
Check the technical specifications of the products by scanning the QR



Monomando de lavabo Plus
Single lever Plus wash-basin mixer
● Ref.: 61130 22 45 66 - **Chrome**



Monomando de lavabo
Single lever wash-basin mixer
● Ref.: 60130 22 45 66 - **Chrome**



Monomando de lavabo centerset 4"
Single lever wash-basin mixer 4" centerset
● Ref.: 60188 22 45 66 - **Chrome**



Monomando de bidé
Single lever bidet mixer
● Ref.: 60140 22 45 66 - **Chrome**



Monomando de bidé con transmisión
Single lever bidet mixer with diverter
● Ref.: 61142 22 45 66 - **Chrome**



Monomando de baño con kit
Single lever bath mixer with kit

● Ref.: 60100 22 45 66 - **Chrome**



Monomando de ducha con kit
Single lever shower mixer with kit

● Ref.: 60110 22 45 66 - **Chrome**



* **Kit incluido**
* Kit included



Monomando de ducha empotrado
Built-in single lever shower mixer

● Ref.: 61115 22 45 66 - **Chrome**



Monomando empotrado con inversor 2 vías
2 way Built-in single lever mixer with diverter

● Ref.: 61116 22 45 66 - **Chrome**



La grifería GENE BRE está diseñada y fabricada según los estándares europeos de calidad, como la UNE-EN 19703 ofreciendo la funcionalidad, durabilidad y seguridad esperadas.

GENEBRE taps are designed and manufactured according to European quality standards, such as UNE-EN 19703, offering the expected functionality, durability and safety.



Monomando empotrado con inversor 2 vías
2 way Built-in single lever mixer with diverter

● Ref.: 61116 22 45 66 - **Chrome**

Rociador ducha con brazo
Wall shower arm and spray

● Ref.: 1698 45 00 - **Chrome**

Caño mural baño fundido
Casted wall bath spout

● Ref.: 1667 45 - **Chrome**

Monomando empotrado con inversor 2 vías
2 way Built-in single lever mixer with diverter

● Ref.: 61116 22 45 66 - **Chrome**

Brazo pared redondo 35 cm
Round wall arm 35 cm

● Ref.: B65113 18 - **Chrome**

Rociador redondo 22 cm
Round shower head Ø 22 cm

● Ref.: R65112 18 - **Chrome**

Barra ducha redonda
Round shower bar

● Ref.: 1638 45 - **Chrome**

Toma ducha mural redonda
Round wall connector

● Ref.: 1680 04 - **Chrome**

Mango de ducha E2 jets
E2 jets handshower

● Ref.: DXE2 45 - **Chrome**

Flexo H 1/2" - H 1/2" 1,70 m inoxidable
F 1/2" - F 1/2" Stainless steel flexible hose 1.70 m

● Ref.: 100135 60 00 - **Chrome**



Grifo lavabo 1 agua cartucho 25
 One-water wash-basin tap 25 cartridge
 ● Ref.: 1002 04 - **Chrome**



Grifo lavabo mural 1 agua cartucho 25
 One-water wall wash-basin tap 25 cartridge
 ● Ref.: 1003 04 - **Chrome**



Grifo doble combinable 1/2"-3/4" y 1/2"
 Double outlet tap 1/2"-3/4" and 1/2"
 ● Ref.: 1023 04 - **Chrome**

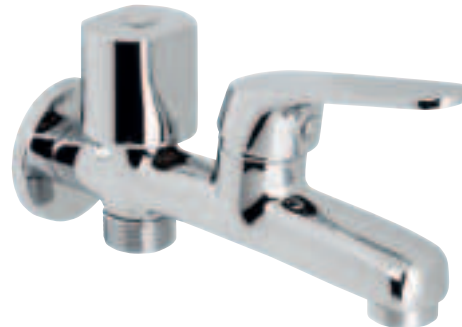

Grifo doble combinable a 1/2"- 3/4" y Aireador
 Double outlet tap 1/2" - 3/4" and aerator
 ● Ref.: 1024 04 - **Chrome**

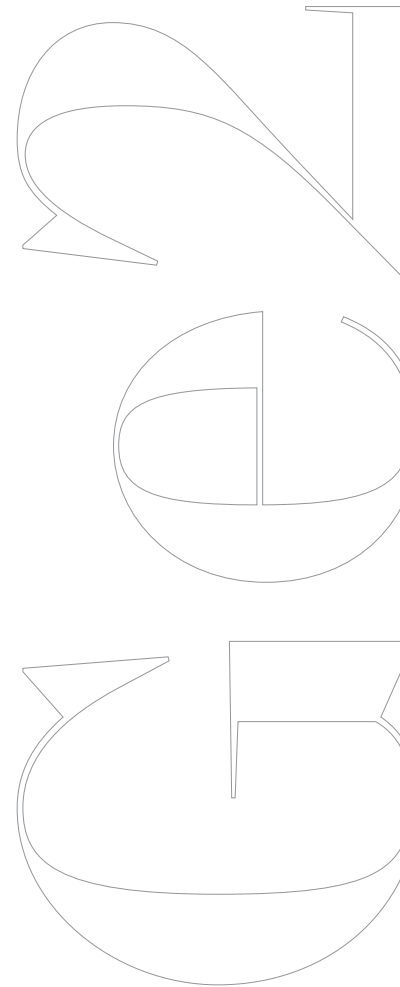



Grifo lavabo mural 1 agua cartucho 25
One-water wall wash-basin tap 25 cartridge
● Ref.: 1006 04 - **Chrome**



Grifo lavabo 1 agua cartucho 25
One-water wash-basin tap 25 cartridge
● Ref.: 1007 04 - **Chrome**



Grifo bide mural 1 agua
1 water wall bidet
● Ref.: 60001 22 45 67 - **Chrome**



Flexo H 1/2" - H 1/2" 1,20 m inoxidable
F 1/2" - F 1/2" Stainless steel flexible hose 1.20 m
● Ref.: 100141 45 - **Chrome**

Kit ducha sanitaria
Sanitary shower kit
● Ref.: 100696 45 - **Chrome**

Consulte la ficha técnica de nuestros productos: Para encontrar toda la información técnica de cualquier producto, localice la referencia del artículo al final de este catálogo, o en nuestra web.

Consult data sheet of our products: Use the item reference to find all of the technical information on any of our products, at the end of this catalogue or our web.



Grifo Lavabo 1 Agua
One-water Wash-basin Tap





New Regent Classic

Glamour vintage / Vintage glamour

La serie New Regent Classic readapta el estilo más clásico, y a veces de elegancia barroca, a los baños y cocinas de hoy. Un excelente y refinado maridaje de calidad, glamour y estilo vintage que nos transporta a épocas lejanas. Disponibles en acabados cromo o bronce.

The New Regent Classic series readapts a most classic style, almost barroque in elegance, to the bathrooms and kitchens of today. An excellent and refined blend of quality, glamour and vintage style that transports us to ancient times. Available in chrome and bronze finidhes..

New Regent Classic

Acabados Finishes:

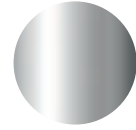

Chrome



Bronze



Consulta las especificaciones técnicas de los productos escaneando el QR
Check the technical specifications of the products by scanning the QR



Monobloc de lavabo cromo

Chrome wash-basin mixer

● Ref.: 68506 09 45 66 - **Chrome**



Monobloc de bidé cromo

Chrome bidet mixer

● Ref.: 68516 09 45 66 - **Chrome**

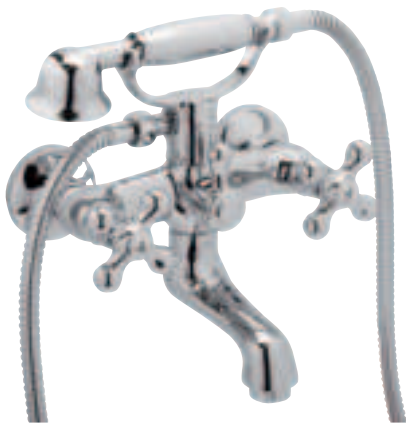

Mezclador de baño cromo con kit *

Chrome bath mixer with kit *

● Ref.: 68526 09 45 66 - **Chrome**



Mezclador de ducha cromo con kit *

Chrome shower mixer with kit *

● Ref.: 68531 09 45 66 - **Chrome**



* **Kit incluido**

* **Kit included**



NEW

Pies para mezclador de bañera *
Floor support for bath mixer *

● Ref.: 65120 45 - **Chrome**

* **Mezclador de baño no incluido**
* Bath mixer not included

Mezclador de baño cromo
Chrome bath mixer

● Ref.: 68526 09 45 66 - **Chrome**



Pies para mezclador para Bañera
Floor Support for Bath Mixer

Ref.: 65120 45

New Regent Classic



Monobloc de lavabo
Wash-basin mixer
● Ref.: 68506 09 43 66 - **Bronze**



Monobloc bidet
Bidet mixer
● Ref.: 68516 09 43 66 - **Bronze**



Mezclador de baño con kit *
Bath mixer with kit *
● Ref.: 68526 09 43 66 - **Bronze**



Mezclador de ducha con kit *
Shower mixer with kit *
● Ref.: 68531 09 43 66 - **Bronze**



* **Kit incluido**
* Kit included

Classic

Acabados *Finishes:*

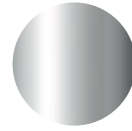

Chrome



Bronze

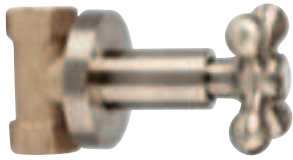

Llave de paso 1/2"
Stopcock 1/2"

● Ref.: 68590 09 43 66 - **Bronze**



Brazo pared redondo 35cm
Round wall arm 35cm

● Ref.: B64113 43 - **Bronze**

Rociador redondo 20cm
round shower head 20cm

● Ref.: R68113 43 - **Bronze**



Válvula universal click para bañera
Click pop-up waste for bath

● Ref.: 100208 43 - **Bronze**



Válvula universal click Luxe con y sin rebosadero
Luxe universal click pop-up waste with and without overflow

● Ref.: 100211 43 - **Bronze**



La grifería GENE BRE está diseñada y fabricada según los estándares europeos de calidad, como la UNE-EN 19703 ofreciendo la funcionalidad, durabilidad y seguridad esperadas.

GENEBRE taps are designed and manufactured according to European quality standards, such as UNE-EN 19703, offering the expected functionality, durability and safety.



New Regent

Distinción y elegancia clásica Classic distinction and elegance

De líneas curvas y volantes en cruz, esta colección está impregnada del estilo vintage del modelo New Regent Classic. Insinuando el pasado, sus líneas más sencillas y evocadoras la convierten en una bella selección de grifos que aportan un toque de romanticismo al ambiente.

With curved lines and cross handled wheels, this collection is permeated with full of vintage style from the New Regent Classic model. Insinuating the past, its simple and evocative lines makes it a beautiful selection of taps that add a touch of romanticism to the ambience.

Acabados Finishes

New Regent



Chrome



Consulta las especificaciones técnicas de los productos escaneando el QR
Check the technical specifications of the products by scanning the QR



Monobloc de lavabo

Wash-basin mixer

● Ref.: 68505 09 45 66 - **Chrome**



Batería lavabo

Widespread wash-basin mixer

● Ref.: 68510 09 45 66 - **Chrome**



Batería lavabo

Widespread wash-basin mixer

● Ref.: 68120 09 45 66 - **Chrome**

Batería Lavabo
Widespread Wash-basin Mixer

Ref.: 68510 09 45 66





Mezclador lavabo 4"
Wash-basin mixer 4"

● Ref.: 68511 09 45 66 - **Chrome**



Grifo lavabo
Wash-basin tap

● Ref.: 68500 09 45 66 - **Chrome**



Monobloc de bidé
Bidet mixer

● Ref.: 68515 09 45 66 - **Chrome**



Grifo bidé
Bidet tap

● Ref.: 68520 09 45 66 - **Chrome**



Batería de bidé con transmisión
Widespread bidet mixed with transmission

● Ref.: 68142 09 45 66 - **Chrome**



Mezclador de baño con kit *
Bath mixer with kit *

● Ref.: 68525 09 45 66 - **Chrome**



Mezclador de ducha con kit *
Shower mixer with kit *

● Ref.: 68530 09 45 66 - **Chrome**



* **Kit incluido**
* Kit included

New

Regent

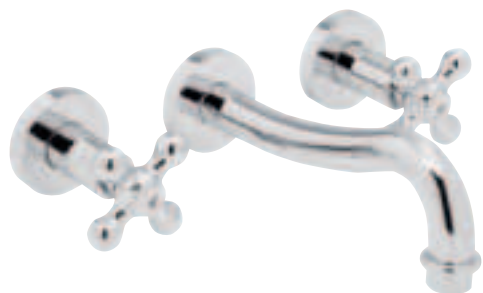

Grupo de lavabo empotrado
Built-in wash-basin mixer
● Ref.: 68131 09 45 66 - **Chrome**



Grupo ducha empotrado 8"
Built-in 8" shower mixer
● Ref.: 68535 09 45 66 - **Chrome**



Grupo baño empotrado 8" con inversor
Built-in 8" bath mixer with diverter
● Ref.: 68527 09 45 66 - **Chrome**

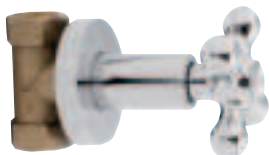

Llave de paso 1/2"
Stopcock 1/2"
● Ref.: 68590 09 45 66 - **Chrome**



Grifo de bidé con teleducha
Bidet tap with shower
● Ref.: 68001 09 45 66 - **Chrome**

Batería Lavabo
Widespread Wash-basin Mixer



Ref.: 68120 09 45 66



Gamma

Discreción intencionada / Intentional discretion

Sencilla y discreta. Ideal para aquellos espacios que buscan funcionalidad. De estilo bimando y características clásicas, los grifos de esta serie ofrecen un excelente equilibrio entre su diseño sereno y la alta calidad.

Simple and discreet. Ideal for those spaces seeking functionality. With dual handles and classic features, the taps in this series offer an excellent balance between their serene design and high quality.

Gamma

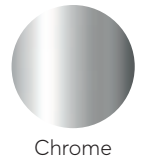

Consulta las especificaciones técnicas de los productos escaneando el QR
Check the technical specifications of the products by scanning the QR



Monobloc de lavabo
Wash-basin mixer

● Ref.: 68130 11 45 66 - **Chrome**



Batería de lavabo
Widespread wash-basin mixer

● Ref.: 68120 11 45 66 - **Chrome**



Mezclador lavabo 4''
Wash-basin mixer 4''

● Ref.: 68122 11 45 66 - **Chrome**



Grifo de lavabo
Wash-basin tap

● Ref.: 68180 11 45 66 - **Chrome**



La grifería GENE BRE está diseñada y fabricada según los estándares europeos de calidad, como la UNE-EN 19703 ofreciendo la funcionalidad, durabilidad y seguridad esperadas.

GENEBRE taps are designed and manufactured according to European quality standards, such as UNE-EN 19703, offering the expected functionality, durability and safety.

Gamma



Monobloc de bidé
Bidet mixer
● Ref.: 68140 11 45 66 - **Chrome**



Grifo bidé
Bidet tap
● Ref.: 68160 11 45 66 - **Chrome**

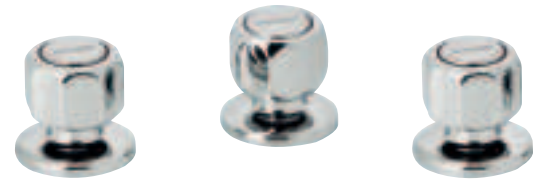

Batería de bidé con transmisión
Widespread bidet mixer with transmission
● Ref.: 68142 11 45 66 - **Chrome**



Mezclador de baño con kit *
Bath mixer with kit *
● Ref.: 68100 11 45 66 - **Chrome**



Mezclador de ducha con kit *
Shower mixer with kit *
● Ref.: 68110 11 45 66 - **Chrome**



* **Kit incluido**
* Kit included



Grupo de lavabo empotrado

Built-in wash-basin

● Ref.: 68131 11 45 66 - **Chrome**



Grupo ducha empotrado 8"

Built-in 8" shower mixer

● Ref.: 68115 11 45 66 - **Chrome**

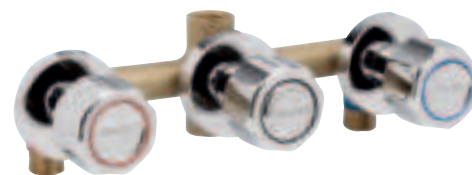

Grupo baño empotrado 8" con inversor

Built-in 8" bath mixer with diverter

● Ref.: 68116 11 45 66 - **Chrome**

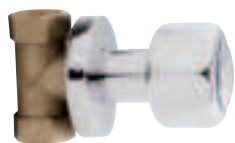

Llave de paso 1/2"

Stopcock 1/2"

● Ref.: 68170 11 45 66 - **Chrome**



Grifo de bidé con teleducha

Bidet tap with shower

● Ref.: 68001 11 45 66 - **Chrome**



Consulte la ficha técnica de nuestros productos: Para encontrar toda la información técnica de cualquier producto, localice la referencia del artículo al final de este catálogo, o en nuestra web.

Consult data sheet of our products: Use the item reference to find all of the technical information on any of our products, at the end of this catalogue or our web.







Ixo

Infinitas posibilidades / Infinite possibilities

Fusión entre elegancia clásica y minimalismo. Los volantes del modelo Ixo de formas geométricas y muy estilizadas son ideales para conjuntar con las múltiples posibilidades de caños que ofrece la colección. Un diseño actual y hermoso que consigue un ambiente muy especial.

A fusion of classic elegance and minimalism. The handles of the Ixo model with geometric stylised forms are ideal to match with the multiple possibilities of spouts that the collection offers. A current, attractive design that achieves a very special ambience.

Ixo



Chrome



Consulta las especificaciones técnicas de los productos escaneando el QR
Check the technical specifications of the products by scanning the QR



Batería de lavabo caño recto
Widespread wash-basin mixer with straight pipe spout
● Ref.: 68120 12 45 66 - **Chrome**



Batería de lavabo caño cisne
Widespread wash-basin mixer with swan pipe spout
● Ref.: 68124 12 45 66 - **Chrome**



Batería de lavabo caño inclinado
Widespread wash-basin mixer with sloping pipe spout
● Ref.: 68125 12 45 66 - **Chrome**

Batería Lavabo Caño Cisne
Widespread Wash-basin Mixer
with Swan Pipe Spout

Ref.: 68124 12 45 66



Las series Kalo, Kross e Ixo nacen de la combinación de diferentes componentes: cuerpos, caños y volantes. Busque la combinación que mejor se adapte a su baño. Puede pedirla utilizando la referencia del catálogo (conjunto) o bien por referencia de cada uno de los componentes (ver información técnica en la página 267).

The series Kalo, Kross and Ixo are born from the combination of different components: bodies, pipes and handles. Look for the combination that best suits your bathroom. You can order it using the set reference or by components reference (see technical information on page 267).



Grupo de lavabo empotrado caño 16 cm
Built-in wash-basin mixer with 16 cm pipe spout

● Ref.: 68131 12 45 66 - **Chrome**

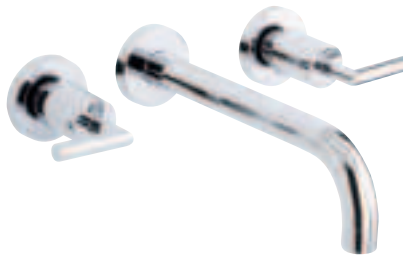

Grupo de lavabo empotrado caño 22 cm
Built-in wash-basin mixer with 22 cm pipe spout

● Ref.: 68132 12 45 66 - **Chrome**



Grupo ducha empotrado 8"
Built-in 8" shower mixer

● Ref.: 68115 12 45 66 - **Chrome**



Grupo ducha empotrado 8" con inversor
Built-in 8" shower mixer with diverter

● Ref.: 68116 12 45 66 - **Chrome**



Inversor cerámico 3 vías empotrado placa redonda

Built-in 3 way ceramic diverter with round plate

● Ref.: 63114 30 45 66 - **Chrome**



Batería de baño con inversor
Widespread bath mixer with diverter

● Ref.: 68113 12 45 66 - **Chrome**



Batería de bidé con transmisión
Widespread bidet mixer with transmission

● Ref.: 68142 12 45 66 - **Chrome**



Llave de paso 1/2"
Stopcock 1/2"

● Ref.: 68170 12 45 66 - **Chrome**



KROSS

En la variedad está el gusto / A taste for diversity

Los volantes de la serie Kross están diseñados para ser los protagonistas de los baños más elegantes. Y la posibilidad de combinarse con diferentes tipos de caños le permite múltiples opciones para adaptarse a cada estilo de baño.

The handle in the Kross series are designed to be the main focus of the most elegant bathrooms. They offer the possibility to combine with different types of spouts that allow for multiple options to adapt to each style of bathroom.

Kross



Chrome



Consulta las especificaciones técnicas de los productos escaneando el QR
Check the technical specifications of the products by scanning the QR



Batería de lavabo caño recto
Widespread wash-basin mixer
with straight pipe spout

● Ref.: 68120 08 45 66 - **Chrome**



Batería de lavabo caño cisne
Widespread wash-basin mixer
with swan pipe spout

● Ref.: 68124 08 45 66 - **Chrome**



Batería de lavabo caño inclinado
Widespread wash-basin mixer
with sloping pipe spout

● Ref.: 68125 08 45 66 - **Chrome**



Batería Lavabo Caño Cisne
Widespread Wash-basin Mixer
with Swan Pipe Spout

Ref.: 68124 05 45 66

Las series Kalo, Kross e Ixo nacen de la combinación de diferentes componentes: cuerpos, caños y volantes. Busque la combinación que mejor se adapte a su baño. Puede pedirla utilizando la referencia del catálogo (conjunto) o bien por referencia de cada uno de los componentes (ver información técnica en la página 265).

The series Kalo, Kross and Ixo are born from the combination of different components: bodies, pipes and handles. Look for the combination that best suits your bathroom. You can order it using the set reference or by components reference (see technical information on page 265).

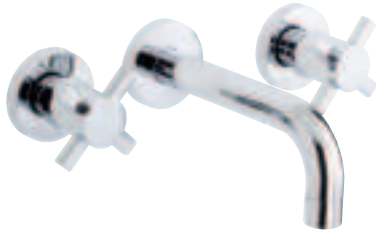

Grupo de lavabo empotrado caño 16 cm

Built-in wash-basin mixer with 16 cm pipe spout

● Ref.: 68131 08 45 66 - **Chrome**

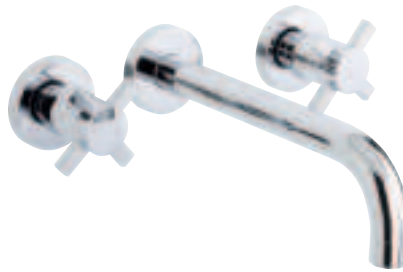

Grupo de lavabo empotrado caño 22 cm

Built-in wash-basin mixer with 22cm pipe spout

● Ref.: 68132 08 45 66 - **Chrome**

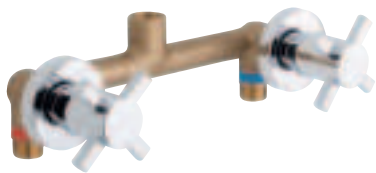

Grupo ducha empotrado 8"

Built-in 8" shower mixer

● Ref.: 68115 08 45 66 - **Chrome**



Grupo ducha empotrado 8" con inversor

Built-in 8" bath mixer with diverter

● Ref.: 68116 08 45 66 - **Chrome**



Inversor cerámico 3 vías empotrado placa redonda

Built-in 3 way ceramic diverter with round plate

● Ref.: 63114 30 45 66 - **Chrome**



Batería de baño con inversor

Widespread bath mixer with diverter

● Ref.: 68113 08 45 66 - **Chrome**



Batería de bidé con transmisión

Widespread bidet mixer with transmission

● Ref.: 68142 08 45 66 - **Chrome**



Llave de paso 1/2"

Stopcock 1/2"

● Ref.: 68170 08 45 66 - **Chrome**



Kalo

Diseño modular para todos los estilos Modular design for all styles

Genebre ha diseñado tres series de grifería bimando que combinan de forma perfecta y armoniosa los diferentes caños y volantes: Kalo, Kross e Ixo. Una propuesta muy versátil de formas sencillas y elegantes que permite múltiples combinaciones, únicas y personales..

Genebre has designed three series of dual-handle taps that perfectly and harmoniously combine these different spouts and handles: Kalo, Kross and Ixo. A versatile design with simple elegant forms which allow for multiple, personal and unique combinations.

Kalo



Chrome



Consulta las especificaciones técnicas de los productos escaneando el QR
Check the technical specifications of the products by scanning the QR



Batería de lavabo caño recto
Widespread wash-basin mixer with straight pipe spout

● Ref.: 68120 07 45 66 - **Chrome**



Batería de lavabo caño cisne
Widespread wash-basin mixer with swan pipe spout

● Ref.: 68124 07 45 66 - **Chrome**



Batería de lavabo caño inclinado
Widespread wash-basin mixer with sloping pipe spout

● Ref.: 68125 07 45 66 - **Chrome**



Grupo de lavabo empotrado caño 16 cm
Built-in wash-basin mixer with 16 cm pipe spout

● Ref.: 68131 07 45 66 - **Chrome**

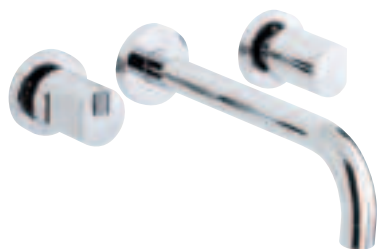

Grupo de lavabo empotrado caño 22 cm
Built-in wash-basin with 22 cm pipe spout

● Ref.: 68132 07 45 66 - **Chrome**



Grupo de Lavabo Empotrado
WBuilt-in Wash-basin Mixer

Ref.: 68137 07 45 66

Las series Kalo, Kross e Ixo nacen de la combinación de diferentes componentes: cuerpos, caños y volantes. Busque la combinación que mejor se adapte a su baño. Puede pedirla utilizando la referencia del catálogo (conjunto) o bien por referencia de cada uno de los componentes (ver información técnica en la página 264).

The series Kalo, Kross and Ixo are born from the combination of different components: bodies, pipes and handles. Look for the combination that best suits your bathroom. You can order it using the set reference or by components reference (see technical information on page 264).

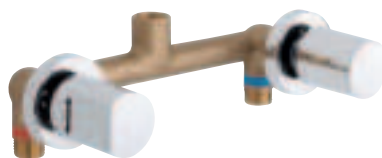

Grupo ducha empotrado 8"

Built-in 8" shower mixer

● Ref.: 68115 07 45 66 - **Chrome**



Grupo baño empotrado 8" con inversor

Built-in 8" bath mixer with diverter

● Ref.: 68116 07 45 66 - **Chrome**



Inversor cerámico 3 vías empotrado placa redonda

Built-in 3 way ceramic diverter with round plate

● Ref.: 63114 30 45 66 - **Chrome**



Batería de baño con inversor

Widespread bath mixer with diverter

● Ref.: 68113 07 45 66 - **Chrome**



Batería de bidé con transmisión

Widespread bidet mixer with transmission

● Ref.: 68142 07 45 66 - **Chrome**



Llave de paso 1/2"

Stopcock 1/2"

● Ref.: 68170 07 45 66 - **Chrome**



Style shower

Duchas con estilo / Showers with style

Para que a la ducha no le falte de nada. Disponemos de una amplia gama de mangos de duchas, accesorios y complementos ideales para cada modelo. Una colección que convierte a cada pieza en una creación inteligente y totalmente flexible para un entorno de bienestar.

For the shower that has everything. We have a wide range of jet handshowers, accessories and complements ideal for each model. A collection that turns each piece in to an intelligent creation, totally flexible for an environment of well being.

Style shower

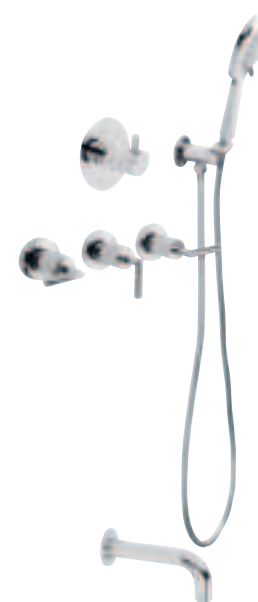
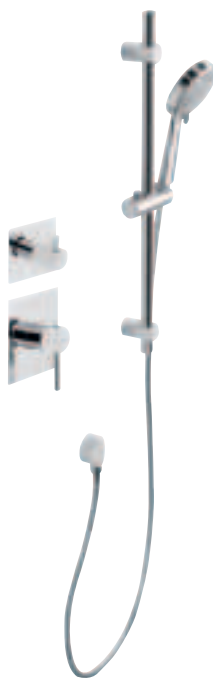

NEW

Inversor cerámico 3 vías empotrado con placa cuadrada
Built-in 3-way ceramic diverter with square plate

● Ref.: 65114 30 45 66 - **Chrome**

Monomando de ducha empotrado
Built-in single lever shower mixer

● Ref.: 65115 18 45 66 - **Chrome**

Rociador doble función cascada-lluvia
Shower head double function waterfall-rain

● Ref.: 1643 45 - **Chrome**

Toma ducha mural redonda
Round wall connector

● Ref.: 1680 04 - **Chrome**

Conjunto Tau, barra, flexo y ducha 5 jets
Tau set, bar, hose and 5 jets handshower

● Ref.: 1748 45 - **Chrome**

Monomando empotrado con inversor cerámico 3 vías
Built-in single lever mixer with 3-way ceramic diverter

● Ref.: 64118 32 45 66 - **Chrome**

Rociador doble función cascada-lluvia
Shower head double function waterfall-rain

● Ref.: 1643 45 - **Chrome**

Soporte de ducha cilíndrico con toma 1/2"
Cylindrical shower holder with 1/2" connector

● Ref.: 1634 04 - **Chrome**

Flexo extensible 1,70 - 2,25 m inoxidable doble grapaje
Extensible stainless steel flexible hose 1,70 to 2,25 m double lock

● Ref.: 100137 60 00 - **Chrome**

Mango de ducha T3 jets
T3 jets handshower

● Ref.: DXT3 45 - **Chrome**

Grupo ducha empotrado 8" con inversor
Built-in 8" shower mixer with diverter

● Ref.: 68116 12 45 66 - **Chrome**

Inversor cerámico 3 vías empotrado placa redonda
Built-in 3 way ceramic diverter with round plate

● Ref.: 63114 30 45 66 - **Chrome**

Rociador doble función cascada-lluvia
Shower head double function waterfall-rain

● Ref.: 1643 45 - **Chrome**

Soporte de ducha orientable cilíndrico con toma 1/2"
Orientable cylindrical shower holder with 1/2" connector

● Ref.: 1633 04 - **Chrome**

Flexo extensible H 1/2" - H 1/2" 1,70 - 2,25 m inoxidable
F 1/2" - F 1/2" Extensible stainless steel flexible hose 1.70 to 2.25 m

● Ref.: 100137 60 00 - **Chrome**

Mango de ducha T3 jets
T3 jets handshower

● Ref.: DXT3 45 - **Chrome**

Caño mural baño cilíndrico
Round wall bath spout

● Ref.: 1668 45 - **Chrome**



**Ejemplos de combinaciones*
para todos los espacios y necesidades.**

Examples of combinations for all kind of
spaces and needs.*

** En cada combinación hay un conjunto de
referencias que han de ser solicitadas para
obtener su conjunto.*

** In each combination there is a set of references
that have to be requested to obtain their set.*



NEW

Monomando empotrado con inversor cerámico 2 vías
Built-in single lever mixer with 2-way ceramic diverter

● Ref.: 64117 32 45 66 - **Chrome**

Brazo pared redondo 35 cm
Round wall arm 35 cm

● Ref.: B65113 18 - **Chrome**

Rociador D22 ovalado
Oval D22 shower sprayer

● Ref.: R63112 08 - **Chrome**

Soporte de ducha cilíndrico con toma 1/2"
Cylindrical shower holder with 1/2" connector

● Ref.: 1634 04 - **Chrome**

Flexo extensible 1,70 - 2,25 m inoxidable doble grapaje
Extensible stainless steel flexible hose 1,70 to 2,25 m double lock

● Ref.: 100137 60 00 - **Chrome**

Mango de ducha T3 jets
T3 jets handshower

● Ref.: DXT3 45 - **Chrome**

Monomando empotrado con inversor cerámico 3 vías
Built-in single lever mixer with 3-way ceramic diverter

● Ref.: 65118 18 45 66 - **Chrome**

Brazo pared redondo 35 cm
Round wall arm 35 cm

● Ref.: B65113 18 - **Chrome**

Rociador redondo 22 cm
Round shower head Ø 22 cm

● Ref.: R65112 18 - **Chrome**

Toma ducha mural redonda
Round wall connector

● Ref.: 1680 04 - **Chrome**

Conjunto Tau, barra, flexo y ducha 5 jets
Tau set, bar, hose and 5 jets handshower

● Ref.: 1748 45 - **Chrome**

Caño mural baño cilíndrico
Round wall bath spout

● Ref.: 1668 45 - **Chrome**

Monomando empotrado con inversor 2 vías
2 way Built-in single lever mixer with diverter

● Ref.: 64116 16 45 66 - **Chrome**

Brazo pared redondo 35 cm
Round wall arm 35 cm

● Ref.: B65113 18 - **Chrome**

Rociador redondo 22 cm
Round shower head Ø 22 cm

● Ref.: R65112 18 - **Chrome**

Caño mural baño cilíndrico
Round wall bath spout

● Ref.: 1668 45 - **Chrome**

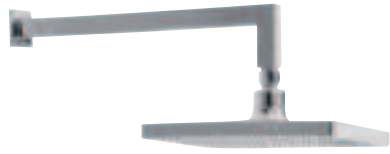

Monomando empotrado con inversor 2 vías
2 way Built-in single lever mixer with diverter

● Ref.: 63116 26 45 66 - **Chrome**

Brazo pared cuadrado 35 cm
Square wall arm 35 cm

● Ref.: B63113 26 - **Chrome**

Rociador cuadrado 22 cm
Square shower head 22 cm

● Ref.: R63112 26 - **Chrome**

Caño mural baño cuadrado
Square wall bath spout

● Ref.: 1674 45 - **Chrome**





Monomando de baño sin kit
Single lever bath mixer without kit

📞 Ref.: 63100 26 45 67 - **Chrome**

Set columna con ducha, soporte y flexo
Column set with shower, holder and flexible hose

📞 Ref.: 1746 45 - **Chrome**

Termostática ducha sin kit
Thermostatic shower mixer without kit

📞 Ref.: 67110 26 45 67 - **Chrome**

Set columna con ducha, soporte y flexo
Column set with shower, holder and flexible hose

📞 Ref.: 1746 45 - **Chrome**



Consulte la ficha técnica de nuestros productos: Para encontrar toda la información técnica de cualquier producto, localice la referencia del artículo al final de este catálogo, o en nuestra web.

Consult data sheet of our products: Use the item reference to find all of the technical information on any of our products, at the end of this catalogue or our web.





Set Columna con Ducha, Soporte y Flexo
Column Set with Shower, Holder and Flexible Hose



Grupo ducha empotrado 8"
Built-in 8" shower mixer

● Ref.: 68115 08 45 66 - **Chrome**

Toma ducha mural redonda
Round wall connector

● Ref.: 1680 04 - **Chrome**

Set columna con ducha, soporte y flexo
Column set with shower, holder and flexible hose

● Ref.: 1745 45 - **Chrome**



Monomando de ducha empotrado
Built-in single lever shower mixer

● Ref.: 64115 16 45 66 - **Chrome**

Toma ducha mural redonda
Round wall connector

● Ref.: 1680 04 - **Chrome**

Set columna con ducha, soporte y flexo
Column set with shower, holder and flexible hose

● Ref.: 1745 45 - **Chrome**



Monomando empotrado con inversor cerámico 3 vías
Built-in single handle mixer with 3-way ceramic diverter

● Ref.: 64118 04 45 66 - **Chrome**

Brazo a techo redondo 15 cm
Round roof arm 15 cm

● Ref.: 1671 45 - **Chrome**

Rociador redondo 22 cm
Round shower head Ø 22 cm

● Ref.: R65112 18 - **Chrome**

Toma ducha mural redonda
Round wall connector

● Ref.: 1680 04 - **Chrome**

Barra ducha metálica
Metallic shower bar

● Ref.: 1639 45 - **Chrome**

Flexo H 1/2" - H 1/2" 1,70 m. PVC antirrotura
F 1/2" - F 1/2" PVC flexible hose 1.70 m anti-breaking

● Ref.: 100140 30 - **Chrome**

Mango de ducha T3 jets
T3 jets handshower

● Ref.: DXT3 45 - **Chrome**

Caño mural baño cilíndrico
Round wall bath spout

● Ref.: 1668 45 - **Chrome**



Set Columna con Ducha, Soporte y Flexo
Column Set with Shower, Holder and Flexible Hose



Monomando empotrado con inversor 2 vías
2 way Built-in single lever mixer with diverter

● Ref.: 63116 26 45 66 - **Chrome**

Brazo a techo cuadrado 15 cm
Square roof arm 15 cm

● Ref.: 1672 45 - **Chrome**

Rociador cuadrado 22 cm
Square shower head 22 cm

● Ref.: R63112 26 - **Chrome**

Toma ducha mural cuadrada
Square wall connector

● Ref.: 1679 04 - **Chrome**

Conjunto Kenjo, barra, flexo y ducha 3 jets
Kenjo set, bar, flexible hose and 3 jets handshower

● Ref.: 1747 45 - **Chrome**

Monomando empotrado con inversor cerámico 2 vías
Built-in single lever mixer with 2 way ceramic diverter

● Ref.: 62117 31 45 66 - **Chrome**

Brazo a techo redondo 15 cm
Round roof arm 15 cm

● Ref.: 1671 45 - **Chrome**

Rociador ovalado 22 cm
Oval shower head 22 cm

● Ref.: R65112 08 - **Chrome**

Soporte de ducha orientable cilíndrico con toma 1/2"
Orientable cylindrical shower holder with 1/2" connector

● Ref.: 1633 04 - **Chrome**

Flexo extensible H 1/2" - H 1/2" 1,70 - 2,25 m inoxidable
F 1/2" - F 1/2" Extensible stainless steel flexible hose 1.70 to 2.25 m

● Ref.: 100137 60 00 - **Chrome**

Mango de ducha O3 jets
O3 jets handshower

● Ref.: DXO3 45 - **Chrome**

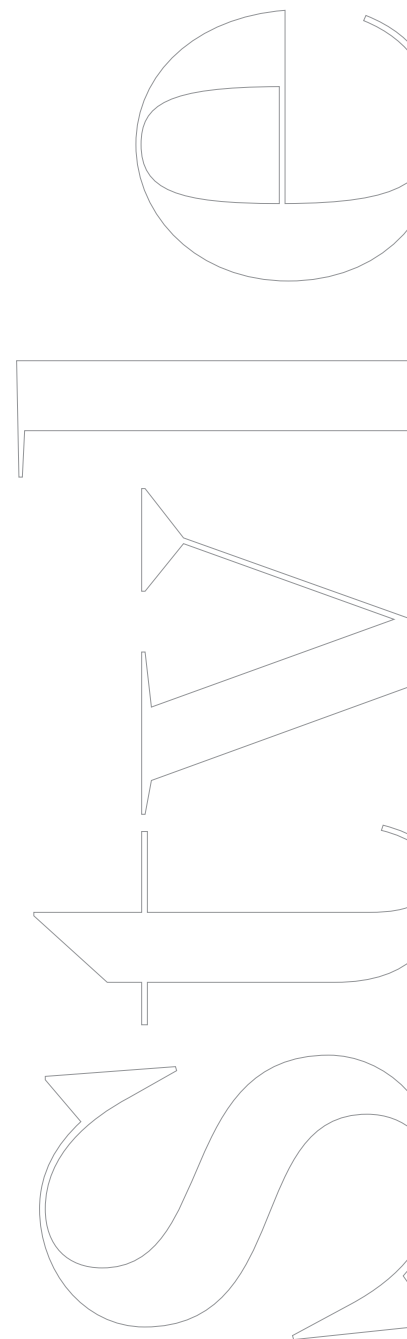



Monomando Empotrado con Inversor Cerámico 2 Vías
Built-in Single Lever Mixer with 2 Way Ceramic Diverter

Grifería empotrada para ducha con sistema GEBOX

Built-in shower taps with GEBOX system

Con el sistema GEBOX de Genebre, ahora la instalación de grifería empotrada para ducha resulta más sencilla, ágil y segura. Gracias a su sistema premontado de cuerpo preinstalado en caja permite una instalación rápida y sencilla. Disponible tanto para monomandos de una vía, como también para monomandos de dos o tres vías. Además, cuenta con un gran abanico de acabados, lo que le otorga gran versatilidad al sistema modular para grifería empotrada, que permite combinar elementos para que se adapten perfectamente a cualquier espacio de baño.

With the GEBOX system from Genebre, the installation of built-in shower taps is now easier, more agile and safer. Thanks to its pre-assembled system with a pre-installed body in a box, it allows for quick and easy installation. Available for both one-way single-lever and also two- or three-way single-lever. In addition, it has a wide range of finishes, which gives great versatility to the modular system for built-in taps, allowing elements to be combined so that they adapt perfectly to any bathroom space.

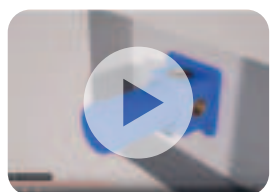

¡Enlaza al video y conoce mejor nuestro sistema GEBOX!

Link to the video and learn about our GEBOX system!

Monomando empotrado premontado sistema GEBOX
GEBOX system pre-assembled built-in single lever mixer

1 vía
1 way



B115 40 45



Kits Placa ducha empotrada
Built-in shower mixer plate Kits



KPB115 40 45



KPC115 40 45



KPT115 40 45



Manetas
Levers



100001 18 45



100001 22 45

Kits Placa ducha empotrada Negro
Black Built-in shower mixer plate Kit



KPC115 40 41

Monomando empotrado premontado sistema GEBOX
 GEBOX system pre-assembled built-in single lever mixer

2 vías
 2 ways



B117 40 45



KPB117 40 45



KPC117 40 45



KPT117 40 45



100001 28 45



100001 29 45

Monomando empotrado premontado sistema GEBOX
 GEBOX system pre-assembled built-in single lever mixer

3 vías
 3 ways



B118 40 45



KPB118 40 45



KPC118 40 45



KPT118 40 45



100001 31 45



100001 32 45



KPC117 40 41



KPC118 40 41

Cocina

Kitchen

El agua es vida. Sólo con verla y oírla, aumenta el flujo sanguíneo en el cerebro y el corazón, y nos relaja.

En Genebre sabemos la gran variedad de beneficios que sólo el agua puede ofrecer. Por eso seguimos mejorando continuamente nuestros productos para que tu experiencia con el agua sea cada día mejor. Esa es nuestra razón de ser y lo que en realidad mejor sabemos hacer.

Water is life. Just seeing and hearing it increases the blood flow in the brain and heart, and relaxes us.

At Genebre, we know the great variety of benefits that only water can offer. That's why we continue improving our products so that your experience with water is better every day. That is our reason for being and what we really know best how to do.

Grifería de cocina para encimeras

Countertop sink mixers

Cartucho **Ø40** Cartridge



Monomando de fregadera KORAL
KORAL Single lever sink mixer
● Ref.: 64201 32 45 66 - **Chrome**



Monomando de fregadera KLIP
KLIP Single lever sink mixer
● Ref.: 64201 16 45 66 - **Chrome**



Monomando de fregadera apertura frío KELOGIC
KELOGIC Single lever sink mixer cold start
● Ref.: 64201 04 45 66 - **Chrome**



Monomando de fregadera cartucho 40 TAU
TAU Single lever sink mixer 40 cartridge
● Ref.: 65214 18 45 66 - **Chrome**



Monomando de fregadera cartucho 40 TAU
TAU Single lever sink mixer 40 cartridge
● Ref.: 65204 18 45 66 - **Chrome**



Monomando de fregadera cartucho 40 TAU
TAU Single lever sink mixer 40 cartridge
● Ref.: 65203 18 45 66 - **Chrome**

Cartucho **Ø40** Cartridge



Monomando de fregadera caño fundido K8
K8 Single lever sink mixer casted spout
● Ref.: 61201 28 45 66 - **Chrome**



Monomando de fregadera caño conformado K8
K8 Single-lever sink mixer tube spout
● Ref.: 61203 28 45 66 - **Chrome**



Monomando de fregadera caño conformado K8
K8 Single-lever sink mixer tube spout
● Ref.: 61204 28 45 66 - **Chrome**



Monomando de fregadera caño fundido K8
K8 Single lever sink mixer casted spout
● Ref.: 61210 28 45 66 - **Chrome**

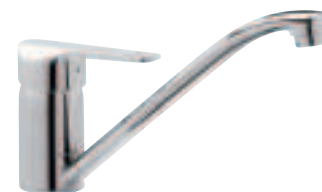

Monomando de fregadera K8
K8 Single lever sink mixer
● Ref.: 61200 28 45 66 - **Chrome**

Grifería de cocina para encimeras

Countertop sink mixers



Consulta las especificaciones técnicas de los productos escaneando el QR
Check the technical specifications of the products by scanning the QR



Cartucho $\varnothing 35$ Cartridge



Monomando de fregadera OSLO
OSLO Single lever sink mixer

● Ref.: 65200 19 45 66 - **Chrome**



Monomando de fregadera apertura en frío OSLO
OSLO Single lever sink mixer cold start

● Ref.: 65203 19 45 66 - **Chrome**



Monomando de fregadera cartucho 35 apertura en frío TAU
TAU Single lever sink mixer 35 cartridge cold start
Ref.: FRT65402



Monomando de fregadera cartucho 35 apertura en frío TAU
TAU Single lever sink mixer 35 cartridge cold start
● Ref.: 65404 18 45 66 - **Chrome**

Cartucho \varnothing 25 Cartridge



NEW

**Monomando de fregadera cartucho 25
apertura en frío TAU**

TAU Single lever sink mixer 25 cartridge
cold start

- Ref.: 65403 18 45 66 - **Chrome**
- Ref.: 65403 18 41 66 - **Black**
- Ref.: 65403 18 40 66 - **White**
- Ref.: 65403 18 44 66 - **Inox**



Monomando de Fregadera
Single Lever Sink Mixer

Ref.: 65403 18 40 66



NEW

**Monomando de fregadera cartucho 25
apertura en frío TAU**

TAU Single lever sink mixer 25 cartridge
cold start

- Ref.: 65215 18 45 66 - **Chrome**



**Monomando de fregadera cartucho 25
apertura en frío TAU**

TAU Single lever sink mixer 25 cartridge
cold start

Ref.: FRT65401

Monomando de Fregadera
Single Lever Sink Mixer



Ref.: FRK63400

Grifería de cocina para encimeras / Countertop sink mixers

Cartucho **Ø25** Cartridge



Monomando de fregadera cartucho 25 apertura en frío TAU

TAU Single lever sink mixer 25 cartridge
cold start

● Ref.: 65219 18 45 66 - **Chrome**



Monomando de fregadera cartucho 25 KENJO

KENJO Single lever sink mixer 25 cartridge
Ref.: FRK63400



Monomando de fregadera cartucho 25 KENJO

KENJO Single lever sink mixer 25 cartridge

● Ref.: FRK63401 - **Chrome**



Monomando mesada 8"

8" widespread single lever sink mixer

● Ref.: 60198 05 45 66 - **Chrome**



Monomando mesada 16cm

16cm widespread single lever sink mixer

● Ref.: 60199 05 45 66 - **Chrome**

Tu manantial de agua pura y sana

Your own source of pure and healthy water

El nuevo sistema de ultrafiltración GENE BRE purifica el agua conservando todos los minerales y propiedades beneficiosas para la salud.

En el proceso de ultrafiltración participan un primer cartucho compuesto de carbón activo de clorador, para el filtrado y retención de olores y sabores, cloro libre, compuestos orgánicos, trihalometanos y DQO. El cartucho verde es de ultra filtración anti bacteriológico con una efectividad superior al 99% la eliminación de E. Coli, bacterias coliformes y aerobios totales.

The new GENE BRE ultrafiltration anti system purifies water conserving all the minerals and properties that are beneficial to your health.

The ultrafiltration process involves a first cartridge composed of dechlorinating active carbon, to filter and retain odours and flavours, free chlorine, organic compounds, trihalomethanes and COD. The green cartridge offers anti-bacteriological ultrafiltration, which is more than 99% effective at eliminating E. coli, coliform and total aerobic bacteria.

Carbón activo de clorador

Dechlorinator activated carbon

El filtro azul elimina olores y malos sabores dejando el agua pura.

The blue filter eliminates odours and bad tastes leaving pure water.

Filtración anti bacteriológica

Anti-bacteriological filtration

El cartucho verde realiza una ultrafiltración anti bacteriológica con una efectividad superior al 99%, para un agua sana.

The green cartridge performs anti-bacteriological ultrafiltration, with more than 99% effectiveness, for healthy water.



Grifería de cocina para filtrado

Sink mixers for filtration



Consulta las especificaciones técnicas de los productos escaneando el QR
Check the technical specifications of the products by scanning the QR



NEW

Monomando de fregadera 3 vías apertura en frío TAU

TAU Single lever 3-way sink mixer cold start

- Ref.: 65702 18 45 66 - **Chrome**
- Ref.: 65702 18 41 66 - **Black**
- Ref.: 65702 18 44 66 - **Inox**



Grifo de 1 vía TAU

TAU One way tap

- Ref.: 65700 18 45 66 - **Chrome**



Monomando de Fregadera
Single Lever Sink Mixer

Ref.: 65702 18 41 66



Kit declorador
Dechlorinator kit
Ref.: FT00



NEW

Kit ultrafiltración
Ultrafiltration kit
Ref.: FT01



NEW

Filtro declorador
Dechlorinator filter
Ref.: FT92



NEW

Filtro ultrafiltración
Ultrafiltration filter
Ref.: FT91

Monomando de Fregadera
Single Lever Sink Mixer



Ref.: FRV61208 44

Grifería de cocina extraíble

Pull out sink mixers



Consulta las especificaciones técnicas de los productos escaneando el QR
Check the technical specifications of the products by scanning the QR



Cartucho $\varnothing 25$ Cartridge



Monomando de fregadera Inox caño extraíble TAU

TAU Stainless steel Single-lever sink mixer with pull-out spout

- Ref.: FRV61208 44 - **Inox**
- Ref.: FRV61208 41 - **Black**
- Ref.: FRV61208 45 - **Chrome**

Cartucho $\varnothing 35$ Cartridge



Monomando de fregadera Inox caño extraíble TAU

TAU Stainless steel Single-lever sink mixer with pull-out spout

- Ref.: FRV61206 - **Chrome**
- Ref.: FRV61207 44 - **Inox**
- Ref.: FRV61207 40 - **White**
- Ref.: FRV61207 41 - **Black**

Grifería de cocina extraíble / Pull out sink mixers

Cartucho Ø40 Cartridge



Monomando de fregadera ducha extraíble
Single lever sink mixer with pull-out spray
● Ref.: 65205 18 45 66 - **Chrome**



Monomando de fregadera caño extraíble TAU
TAU Single lever sink mixer with pull-out spout
● Ref.: 65206 18 45 66 - **Chrome**



Monomando de fregadera ducha extraíble TAU
TAU Single lever sink mixer with pull-out spray
● Ref.: FRV61205 - **Chrome**



Monomando de fregadera ducha extraíble KORAL
KORAL Single lever sink mixer with pull-out spray
● Ref.: 64206 32 45 66 - **Chrome**



Monomando de fregadera ducha extraíble KLIP
KLIP Single lever sink mixer with pull-out spray
● Ref.: 64206 16 45 66 - **Chrome**



Monomando de fregadera ducha extraíble K8
K8 Single-lever sink mixer with pull-out spray
● Ref.: 61206 28 45 66 - **Chrome**



Monomando de fregadera ducha extraíble K8
K8 Single lever sink mixer with pull-out spray
● Ref.: 61205 28 45 66 - **Chrome**



Monomando de Fregadera
Single Lever Sink Mixer

Ref.: FRV61205

Monomando de Fregadera
Single Lever Sink Mixer



Grifería de cocina con muelle

Sink mixers with spring

Cartucho $\varnothing 35$ Cartridge



Monomando de fregadera inox con muelle y ducha extraíble TAU

TAU Stainless steel single lever sink mixer with spring and pull-out sprayer

● Ref.: 65207 18 60 66 - **Inox**



Monomando de fregadera inox con muelle TAU

TAU Stainless steel single lever sink mixer with spring

● Ref.: 65211 18 60 66 - **Inox**



Monomando de fregadera con muelle TAU

TAU Single lever sink mixer with spring

● Ref.: 65211 18 45 66 - **Chrome**



Monomando de fregadera con muelle y caño TAU

TAU Single lever sink mixer with spring and spout

● Ref.: 65212 18 45 66 - **Chrome**



Consulta las especificaciones técnicas de los productos escaneando el QR
Check the technical specifications of the products by scanning the QR



Grifería de cocina mural

Wall-mounted sink mixers



Consulta las especificaciones técnicas de los productos escaneando el QR
Check the technical specifications of the products by scanning the QR



Cartucho $\varnothing 40$ Cartridge



Monomando de fregadera mural KORAL

KORAL Wall single lever sink mixer

● Ref.: 64192 32 45 66 - **Chrome**

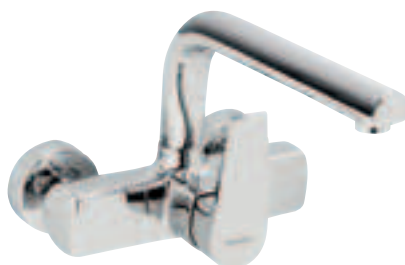

Monomando de fregadera mural KLIP

KLIP Wall single lever sink mixer

● Ref.: 64192 16 45 66 - **Chrome**

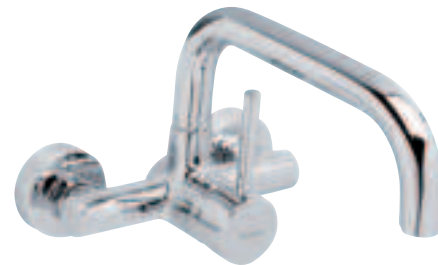

Monomando de fregadera mural 15 cm TAU

TAU Wall single lever sink mixer 15 cm

● Ref.: 65192 18 45 66 - **Chrome**



Monomando de fregadera mural 11 cm

Wall single lever sink mixer 11 cm

● Ref.: 61195 28 45 66 - **Chrome**

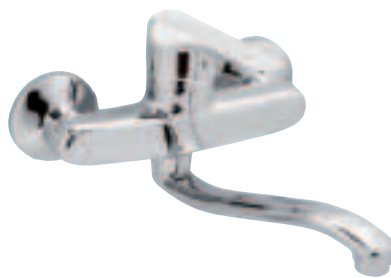

Monomando de fregadera caño inferior elevado K8

K8 Wall single lever sink mixer low spout

● Ref.: 61196 28 45 66 - **Chrome**

Cartucho **Ø40** Cartridge



Monomando de fregadera mural 15 cm, caño corto

Wall single lever sink mixer 15 cm, short spout

● Ref.: 61190 28 45 66 - **Chrome**



Monomando de fregadera mural 15 cm, caño largo

Wall single-lever sink mixer 15 cm, long spout

● Ref.: 61192 28 45 66 - **Chrome**

Cartucho **Ø35** Cartridge



Monomando de fregadera mural 15 cm OSLO

OSLO Wall single lever sink mixer 15 cm

● Ref.: 65192 19 45 66 - **Chrome**



Monomando de fregadera mural 8"

Wall single lever 8" sink mixer

● Ref.: 60194 05 45 66 - **Chrome**



La grifería GENE BRE está diseñada y fabricada según los estándares europeos de calidad, como la UNE-EN 19703 ofreciendo la funcionalidad, durabilidad y seguridad esperadas.

GENEBRE taps are designed and manufactured according to European quality standards, such as UNE-EN 19703, offering the expected functionality, durability and safety.



Monomando de Fregadera Mural
Wall Single Lever Sink Mixer

Ref.: 61190 28 45 66

Grifería de cocina abatible

Folding sink mixers



Consulta las especificaciones técnicas de los productos escaneando el QR
Check the technical specifications of the products by scanning the QR



Cartucho $\varnothing 35$ Cartridge

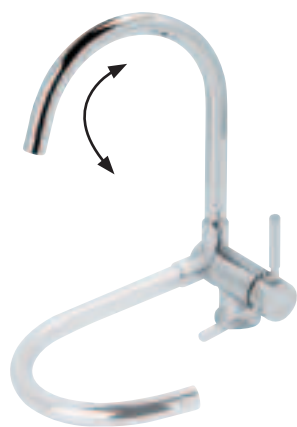

Monomando de fregadera abatible cartucho 35 apertura en frío TAU
TAU Single lever folding sink mixer 35 cartridge cold start

● Ref.: 65900 18 45 66 - **Chrome**

Cartucho $\varnothing 40$ Cartridge



Monomando de fregadera abatible K8
K8 Single lever folding sink mixer

● Ref.: 61900 28 45 66 - **Chrome**



Grifería de cocina selección Inox

Stainless steel selection sink mixers



Consulta las especificaciones técnicas de los productos escaneando el QR
Check the technical specifications of the products by scanning the QR



Ref.: 65219 40 60 66

Beneficios del acero inoxidable en la cocina:

La serie Inox está diseñada especialmente para el mundo de la cocina, su material es ideal para cubrir todas las garantías de higiene y sanitarias y resultan más inalterables al uso.

Benefits of stainless steel in the kitchen:

The Inox series is specially designed for the kitchen world, its material is ideal to cover all hygiene and sanitary guarantees and is more unalterable when used.

Cartucho Ø35 Cartridge



Monomando de fregadera inox caño cisne TAU

TAU Stainless steel single lever sink mixer with swan pipe

● Ref.: 65203 18 60 66 - **Inox**



Monomando de fregadera inox con muelle TAU

TAU Stainless steel single lever sink mixer with spring

● Ref.: 65211 18 60 66 - **Inox**



Monomando de fregadera inox con muelle y ducha extraíble TAU

TAU Stainless steel single lever sink mixer with spring and pull-out sprayer

● Ref.: 65207 18 60 66 - **Inox**

Grifería de cocina selección Inox / Stainless steel selection sink mixers

Cartucho Ø25 Cartridge



Monomando de fregadera inox cartucho 25

Stainless steel single lever sink mixer
25 cartridge

● Ref.: 65215 40 60 66 - **Inox**



Monomando de fregadera inox cartucho 25

TAU 2
TAU 2 Stainless steel single lever sink mixer
25 cartridge

● Ref.: 65219 40 60 66 - **Inox**





Monomando de Fregadera Inox
Stainless Steel Single Lever Sink Mixer

Ref.: 65215 40 60 66

Grifería de cocina Classic

Classic sink mixers

Encimeras Countertop

New Regent

Cartucho $\varnothing 40$ Cartridge



Consulta las especificaciones técnicas de los productos escaneando el QR
Check the technical specifications of the products by scanning the QR



Monomando de fregadera NEW REGENT
NEW REGENT sink mixer
● Ref.: 68201 39 43 66 - **Bronze**



Monomando de fregadera NEW REGENT
NEW REGENT sink mixer
● Ref.: 68201 39 45 66 - **Chrome**

Montura cerámica Ceramic frame



Monobloc de fregadera NEW REGENT
NEW REGENT sink mixer
● Ref.: 68595 09 43 66 - **Bronze**



Monobloc de fregadera NEW REGENT
NEW REGENT sink mixer
● Ref.: 68595 09 45 66 - **Chrome**

Monomando de Fregadera
Single Lever Sink Mixer



Grifería de cocina Classic / Classic sink mixers

Encimeras Countertop

New Regent

Montura cerámica Ceramic frame



Monobloc fregadera caño tubo
NEW REGENT
NEW REGENT Sink mixer, swan neck spout
● Ref.: 68540 09 45 66 - **Chrome**



Grifo fregadera encimera caño tubo vertical
NEW REGENT
NEW REGENT Deck sink tap
with swan neck spout
● Ref.: 68585 09 45 66 - **Chrome**



Mezclador mesada 8" caño tubo
NEW REGENT
NEW REGENT 8" deck mixer
with swan neck spout
● Ref.: 68545 09 45 66 - **Chrome**



Mezclador mesada 16 cm caño tubo
NEW REGENT
NEW REGENT 16 cm deck mixer
with swan neck spout
● Ref.: 68194 09 45 66 - **Chrome**

Gamma

Montura cerámica Ceramic frame



Monobloc de fregadera caño tubo GAMMA

GAMMA Sink mixer, swan neck spout

● Ref.: 68200 11 45 66 - **Chrome**



Mezclador mesada 6" caño tubo GAMMA

GAMMA 6" deck mixer with swan neck spout

● Ref.: 68194 11 45 66 - **Chrome**



Mezclador mesada 8" caño tubo GAMMA

GAMMA 8" deck mixer with swan neck spout

● Ref.: 68199 11 45 66 - **Chrome**



Grifo fregadera encimera caño tubo vertical GAMMA

GAMMA Deck sink tap with swan neck spout

● Ref.: 68003 11 45 66 - **Chrome**



Grifería de cocina Classic / Classic sink mixers

Mural Wall

New Regent

Montura cerámica Ceramic frame

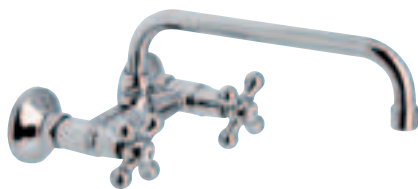

Grupo mural fregadera 15 cm caño tubo alto 24 cm NEW REGENT
NEW REGENT Wall sink mixer with 15 cm with high tube, 24 cm spout

● Ref.: 68555 09 45 66 - **Chrome**



Grupo mural fregadera 15 cm caño tubo bajo 24 cm NEW REGENT
NEW REGENT Wall sink mixer with 15cm low tube, 24 cm spout

● Ref.: 68560 09 45 66 - **Chrome**

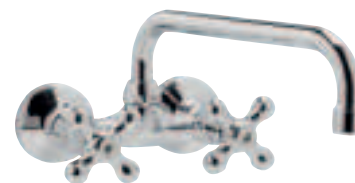

Grupo mural fregadera 11 cm caño tubo alto 24 cm NEW REGENT
NEW REGENT Wall sink mixer with 11cm high tube, 24 cm spout

● Ref.: 68196 09 45 66 - **Chrome**

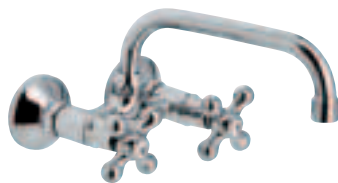

Grupo mural fregadera 11 cm caño tubo alto 18 cm NEW REGENT
NEW REGENT Wall sink mixer with 11 cm high tube, 18 cm spout

● Ref.: 68550 09 45 66 - **Chrome**



Grupo mural fregadera 20 cm caño tubo alto 24 cm NEW REGENT
NEW REGENT 20 cm wall sink mixer with high tube, 24 cm spout

● Ref.: 68565 09 45 66 - **Chrome**



Grupo mural fregadera 20 cm caño tubo alto vertical NEW REGENT
NEW REGENT 20 cm wall sink mixer with swan neck spout

● Ref.: 68570 09 45 66 - **Chrome**

Classico

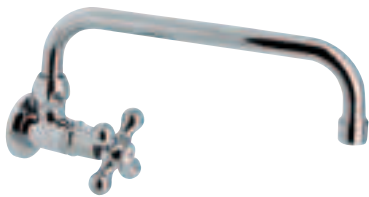

Grifo mural fregadera caño tubo alto 24 cm NEW REGENT
NEW REGENT Wall sink tap with tube spout 24 cm

● Ref.: 68580 09 45 66 - **Chrome**



Grifo fregadera mural caño tubo vertical NEW REGENT
NEW REGENT Wall sink tap with swan neck spout

● Ref.: 68575 09 45 66 - **Chrome**



La grifería GENE BRE está diseñada y fabricada según los estándares europeos de calidad, como la UNE-EN 19703 ofreciendo la funcionalidad, durabilidad y seguridad esperadas.

GENEBRE taps are designed and manufactured according to European quality standards, such as UNE-EN 19703, offering the expected functionality, durability and safety.

Grifería de cocina Classic / Classic sink mixers

Mural Wall

New Regent

Montura cerámica Ceramic frame



Cuerpo grupo mural 20 cm NEW REGENT
NEW REGENT Wall body mixer 20 cm
Ref.: 568565 45



Cuerpo grupo mural 15 cm NEW REGENT
NEW REGENT Wall body mixer 15 cm
Ref.: 568555 45



Cuerpo grupo mural 11 cm NEW REGENT
NEW REGENT Wall body mixer 11 cm
Ref.: 568550 45



Cuerpo grifo mural NEW REGENT
NEW REGENT Wall body tap
Ref.: 568575 45



Caño alto tubo 18 cm
High pipe spout 18 cm
Ref.: 68901 45

Caño alto tubo 24 cm
High pipe spout 24 cm
Ref.: 68902 45

Caño alto tubo 30 cm
High tube spout 30 cm
Ref.: 68908 45



Caño tubo vertical
Vertical pipe spout
Ref.: 68903 45



Caño bajo tubo 18 cm
Low tube spout 18 cm
Ref.: 68910 45

Caño bajo tubo 24 cm
Low tube spout 24 cm
Ref.: 68904 45

Caño bajo tubo 30 cm
Low tube spout 30 cm
Ref.: 68909 45

Grifería de cocina Classic / Classic sink mixers

Mural Wall

Gamma

Montura convencional Conventional frame

**Grupo mural fregadera 15 cm caño tubo alto 24 cm GAMMA**

GAMMA Wall sink mixer with 15 cm with high tube, 24 cm spout

● Ref.: 68193 11 45 66 - **Chrome****Grupo mural fregadera 15 cm caño tubo bajo 24 cm GAMMA**

GAMMA Wall sink mixer with 15cm low tube, 24 cm spout

● Ref.: 68197 11 45 66 - **Chrome****Grupo mural fregadera 11 cm caño tubo alto 24 cm GAMMA**

GAMMA Wall sink mixer with 11 cm, high tube 24 cm spout

● Ref.: 68196 11 45 66 - **Chrome****Grupo mural fregadera 11 cm caño tubo alto 18 cm GAMMA**

GAMMA Wall sink mixer with 11cm high tube, 18 cm spout

● Ref.: 68195 11 45 66 - **Chrome****Grupo mural fregadera 20 cm caño tubo alto 24 cm GAMMA**

GAMMA 20 cm wall sink mixer with high tube, 24 cm spout

● Ref.: 68104 11 45 66 - **Chrome****Grupo mural fregadera 20 cm caño tubo alto vertical GAMMA**

GAMMA 20 cm wall sink mixer with swan neck spout

● Ref.: 68103 11 45 66 - **Chrome**

Grifería de cocina Classic / Classic sink mixers

Mural Wall

Gamma

Montura convencional Conventional frame



Grupo mural fregadera 15 cm caño tubo alto 18 cm GAMMA

GAMMA Wall sink mixer with 15 cm, high tube, 18 cm spout

● Ref.: 68190 11 45 66 - **Chrome**



Grifo mural fregadera caño tubo alto 24 cm GAMMA

GAMMA Wall sink tap with tube spout 24 cm

● Ref.: 68093 11 45 66 - **Chrome**



Grifo fregadera mural caño tubo vertical GAMMA

GAMMA Wall sink tap with swan neck spout

● Ref.: 68083 11 45 66 - **Chrome**

Classic



Cuerpo grupo mural 20 cm GAMMA
 GAMMA Wall body mixer 20 cm
 Ref.: 568104 45



Cuerpo grupo mural 15 cm GAMMA
 GAMMA Wall body mixer 15 cm
 Ref.: 568193 45



Cuerpo grupo mural 11 cm GAMMA
 GAMMA Wall body mixer 11 cm
 Ref.: 568195 45



Cuerpo grifo mural GAMMA
 GAMMA Wall body tap
 Ref.: 568083 45



Caño alto tubo 18 cm
 High pipe spout 18 cm
 Ref.: 68901 45



Caño tubo vertical
 Vertical pipe spout
 Ref.: 68903 45



Caño bajo tubo 18 cm
 Low tube spout 18 cm
 Ref.: 68910 45

Caño alto tubo 24 cm
 High pipe spout 24 cm
 Ref.: 68902 45

Caño alto tubo 30 cm
 High tube spout 30 cm
 Ref.: 68908 45

Caño bajo tubo 24 cm
 Low tube spout 24 cm
 Ref.: 68904 45

Caño bajo tubo 30 cm
 Low tube spout 30 cm
 Ref.: 68909 45

Grifería de cocina de 1 agua

One-tap sink taps



Consulta las especificaciones técnicas de los productos escaneando el QR
Check the technical specifications of the products by scanning the QR



Grifo mural con tubo 24 cm 1 agua cartucho 25
One-water wall sink tap spout 24 cm 25 cartridge
Ref.: 1008 04



Grifo fregadera 1 agua cartucho 25
One-water sink tap 25 cartridge
Ref.: 1009 04



Grifo mural con tubo alto 1 agua cartucho 25
One-water wall sink tap high spout 25 cartridge
Ref.: 1005 04



Grifo doble combinable a 1/2"- 3/4" y Aireador
Double outlet tap 1/2" - 3/4" and aerator
Ref.: 1024 04



Grifo doble combinable 1/2"-3/4" y 1/2"
Double outlet tap 1/2"-3/4" and 1/2"
Ref.: 1023 04



La grifería GENE BRE está diseñada y fabricada según los estándares europeos de calidad, como la UNE-EN 19703 ofreciendo la funcionalidad, durabilidad y seguridad esperadas.

GENEBRE taps are designed and manufactured according to European quality standards, such as UNE-EN 19703, offering the expected functionality, durability and safety.



Accesorios

Accessories

Hasta el último detalle.

Genebre te ofrece una larga lista de accesorios y complementos funcionales y decorativos ideales para combinar con nuestros modelos de grifería y dar un toque personal a cada baño.

Down to the last detail.

Genebre offers a long list of accessories and functional and decorative complements, ideal to combine with our models of taps, and give a personal touch to each bathroom.

Mangos de ducha / Handshowers



Consulta las especificaciones técnicas de los productos escaneando el QR
Check the technical specifications of the products by scanning the QR



Mango de ducha K3 jets
K3 jets handshower
Ref.: DXK3 45



Mango de ducha K1 jets
K1 jet handshower
Ref.: DXK1 45



Mango de ducha O3 jets
O3 jets handshower
Ref.: DXO3 45



Mango de ducha T3 jets
T3 jets handshower
Ref.: DXT3 45



Mango de ducha L3 jets
L3 jets handshower
● Ref.: DXL3 45 - **Chrome**
● Ref.: DXL3 41 - **Black**
● Ref.: DXL3 51 - **Brushed Gold**
● Ref.: DXL3 52 - **Brushed Metal**



Mango de ducha T5 jets
T5 jets handshower
Ref.: DXT5 45



Mango de ducha E1 jet
E1 jet handshower
Ref.: 100175 45 00



Mango de ducha E2 jets
E2 jets handshower
Ref.: DXE2 45



Mango de ducha E5 jets
E5 jets handshower
Ref.: DXE5 45



Mango de ducha C1 jet
C1 jet handshower
● Ref.: 100197 45 00 - **Chrome**



La grifería GENE BRE está diseñada y fabricada según los estándares europeos de calidad, como la UNE-EN 19703 ofreciendo la funcionalidad, durabilidad y seguridad esperadas.

GENEBRE taps are designed and manufactured according to European quality standards, such as UNE-EN 19703, offering the expected functionality, durability and safety.

Kits de ducha / Shower kits



Kit de ducha Kenjo, flexo, soporte y ducha 3 jets
Kenjo shower set, flexible hose, holder and 3 jets handshower
Ref.: 100698 45



Kit de ducha Tau, flexo, soporte y ducha 5 jets
Tau shower set, flexible hose, holder and 5 jets handshower
Ref.: 100699 45



Kit de ducha GE2, flexo, soporte y ducha 1 jet
GE2 shower set, flexible hose, holder and 1 jet handshower
Ref.: 100697 45

Flexos / Flexible hoses



Flexo H 1/2" - H 1/2" 1,20 m inoxidable
F 1/2" - F 1/2" Stainless steel flexible hose 1.20 m

- Ref.: 100141 45 - **Chrome**
- Ref.: 9908 0285 - **Black**
- Ref.: 100141 51 - **Brushed Gold**
- Ref.: 100141 52 - **Brushed Metal**



Flexo H 1/2" - H 1/2" 1,70 m inoxidable
F 1/2" - F 1/2" Stainless steel flexible hose 1.70 m

- Ref.: 100135 60 00 - **Chrome**
- Ref.: 9908 0287 - **Black**
- Ref.: 100135 51 00 - **Brushed Gold**
- Ref.: 100135 52 00 - **Brushed Metal**



Flexo extensible H 1/2" - H 1/2" 1,70 - 2.25 m inoxidable
F 1/2" - F 1/2" Extensible stainless steel flexible hose 1.70 to 2.25 m

Ref.: 100137 60 00



Flexo H 1/2" - H 1/2" 1,70 m PVC antirrotura
F 1/2" - F 1/2" PVC flexible hose 1.70 m anti-breaking

Ref.: 100140 30

Soportes de ducha / Shower holders



Soporte ducha Kenjo
Kenjo shower holder
Ref.: 100149 45



Soporte ducha
Shower holder
Ref.: 100152 45 00



Soporte ducha cilíndrico
Cylindrical shower holder
● Ref.: 100153 45 - **Chrome**
● Ref.: 100153 41 - **Black**
● Ref.: 100153 51 - **Brushed Gold**
● Ref.: 100153 52 - **Brushed Metal**



Soporte de ducha ovalado
Oval shower holder
Ref.: 100068 45



Soporte de ducha orientable cuadrado con toma 1/2"
Orientable square shower holder with 1/2" connector
Ref.: 1649 04

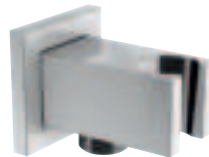

Soporte de ducha cuadrado con toma 1/2"
Square shower holder with 1/2" connector
Ref.: 1635 04



Soporte ducha cilíndrico con toma 1/2"
Cylindrical shower holder with 1/2" connector
● Ref.: 1634 04 - **Chrome**
● Ref.: 1946 41 - **Black**
● Ref.: 1946 51 - **Brushed Gold**
● Ref.: 1946 52 - **Brushed Metal**



Soporte de ducha orientable cilíndrico con toma 1/2"
Orientable cylindrical shower holder with 1/2" connector
Ref.: 1633 04

Tomas de ducha / Wall connectors



Toma ducha mural cuadrada
Square wall connector
Ref.: 1679 04



Toma ducha mural redonda
Round wall connector
● Ref.: 1680 04 - **Chrome**
● Ref.: 1618 41 - **Black**
● Ref.: 1618 51 - **Brushed Gold**
● Ref.: 1618 52 - **Brushed Metal**

Conjuntos barra / Bar sets



Conjunto Kenjo, barra, flexo y ducha 3 jets
Kenjo set, bar, flexible hose and 3 jets
handshower
Ref.: 1747 45



Conjunto Tau, barra, flexo y ducha 5 jets
Tau set, bar, hose and 5 jets handshower
Ref.: 1748 45



Barra ducha Kenjo
Kenjo shower bar
Ref.: 1637 45



Barra ducha redonda
Round shower bar
Ref.: 1638 45

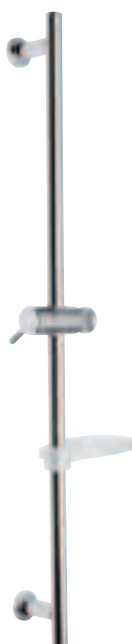

Barra ducha metálica
Metallic shower bar
Ref.: 1639 45



Barra ducha TAU
TAU shower bar
● Ref.: 1636 45 - **Chrome**
● Ref.: 1636 41 - **Black**
● Ref.: 1636 51 - **Brushed Gold**
● Ref.: 1636 52 - **Brushed Metal**

NEW

Rociadores y brazos / Shower heads and sprayer arms



Rociador doble función cascada-lluvia
Shower head double function waterfall-rain
Ref.: 1643 45



NEW

Brazo pared redondo 35 cm
Round wall arm 35 cm
● Ref.: B65113 18 - **Chrome**
● Ref.: B64113 43 - **Bronze**
● Ref.: B64113 41 - **Black**
● Ref.: B64113 51 - **Brushed Gold**
● Ref.: B64113 52 - **Brushed Metal**



NEW

Brazo a techo redondo 15 cm
Round roof arm 15 cm
● Ref.: 1671 45 - **Chrome**
● Ref.: 1671 41 - **Black**
● Ref.: 1671 51 - **Brushed Gold**
● Ref.: 1671 52 - **Brushed Metal**



Brazo pared cuadrado 35 cm
Square wall arm 35 cm
Ref.: B63113 26



Brazo a techo cuadrado 15 cm
Square roof arm 15 cm
Ref.: 1672 45



Brazo pared redondo 24 cm
Round wall 24 cm
Ref.: B65114 18



Rociador redondo 22 cm
Round shower head Ø 22 cm
● Ref.: R65112 18 - **Chrome**



Rociador D22 Oslo Black
Oslo Black D22 shower head
● Ref.: R65112 41- **Black**



Rociador redondo 20 cm Bronze
Bronze round shower head Ø 20 cm
● Ref.: R68113 43 - **Bronze**

Rociadores y brazos / Shower heads and sprayer arms



Rociador cuadrado 22 cm
Square shower head 22 cm
Ref.: R63112 26



Rociador D22 ovalado
Oval D22 shower sprayer
Ref.: R63112 08



Rociador cilíndrico 10 cm
Cylindrical shower head 10 cm
Ref.: R1155 04



Rociador redondo 25 cm
Round shower head 25 cm
● Ref.: R65110 60 - **Chrome**
● Ref.: R65110 41 - **Black**
● Ref.: R65110 51 - **Brushed Gold**
● Ref.: R65110 52 - **Brushed Metal**



Rociador cuadrado 25 cm Inox
Square shower head 25 cm
● Ref.: R65130 60 - **Chrome**
● Ref.: R65130 41 - **Black**
● Ref.: R65130 51 - **Brushed Gold**
● Ref.: R65130 52 - **Brushed Metal**



Rociador redondo 30 cm
Round shower head 30 cm
● Ref.: R65150 60 - **Inox**

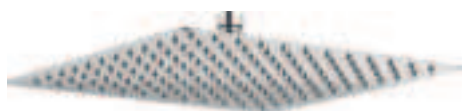

Rociador cuadrado 30 cm
Square shower head 30 cm
● Ref.: R65170 70 - **Inox**



Rociador ducha con brazo
Wall shower arm and spray
Ref.: 1698 45 00

Válvulas de escuadra / Angle valves



Válvula de escuadra cuadrada 3/8"
Square angle valve 3/8"

Ref.: 3106 04

Válvula de escuadra cuadrada 1/2"
Square angle valve 1/2"

Ref.: 3106 05



Válvula de escuadra redonda 3/8"
Round angle valve 3/8"

- Ref.: 3104 04 - **Chrome**
- Ref.: 3110 03 41 - **Black**
- Ref.: 3110 03 51 - **Brushed Gold**
- Ref.: 3110 03 52 - **Brushed Metal**

Válvula de escuadra redonda 1/2"
Round angle valve 1/2"

- Ref.: 3104 05 - **Chrome**
- Ref.: 3110 04 41 - **Black**
- Ref.: 3110 04 51 - **Brushed Gold**
- Ref.: 3110 04 52 - **Brushed Metal**



Válvula de escuadra doble 1/2" - 3/8"
Double angle valve 1/2" - 3/8"

Ref.: 3109 04

Válvula de escuadra doble 1/2" - 1/2"
Double angle valve 1/2" - 1/2"

- Ref.: 3109 05 - **Chrome**
- Ref.: 3113 05 41 - **Black**
- Ref.: 3113 05 51 - **Brushed Gold**
- Ref.: 3113 05 52 - **Brushed Metal**



NEW

Kit ducha sanitaria
Sanitary shower kit

- Ref.: 100694 45 - **Chrome**
- Ref.: 100694 41 - **Black**
- Ref.: 100694 60 - **Inox**
- Ref.: 100694 51 - **Brushed Gold**
- Ref.: 100694 52 - **Brushed Metal**



Kit ducha sanitaria
Sanitary shower kit

Ref.: 100696 45



NEW

Llave de paso 1/2"
1/2" Stopcock

- Ref.: 60170 41 45 66 - **Chrome**
- Ref.: 60170 41 41 66 - **Black**
- Ref.: 60170 41 51 66 - **Brushed Gold**
- Ref.: 60170 41 52 66 - **Brushed Metal**

Kits de ducha / Shower kits



NEW

Llave de paso 3/4"
3/4" Stopcock

- Ref.: 60171 41 45 66 - **Chrome**
- Ref.: 60171 41 41 66 - **Black**
- Ref.: 60171 41 51 66 - **Brushed Gold**
- Ref.: 60171 41 52 66 - **Brushed Metal**



Mezclador sanitario de ducha con soporte
Sanitary shower mixer with support

- Ref.: 65144 19 45 67 - **Chrome**
- Ref.: 65144 19 41 67 - **Black**
- Ref.: 65144 19 51 67 - **Brushed Gold**
- Ref.: 65144 19 52 67 - **Brushed Metal**



Set mezclador sanitario de ducha con soporte
Sanitary shower mixer set with support

- Ref.: 65144 19 45 66 - **Chrome**



Pies para mezclador de bañera
Floor support for bath mixer
Ref.: 65120 45



La grifería GENE BRE está diseñada y fabricada según los estándares europeos de calidad, como la UNE-EN 19703 ofreciendo la funcionalidad, durabilidad y seguridad esperadas.

GENEBRE taps are designed and manufactured according to European quality standards, such as UNE-EN 19703, offering the expected functionality, durability and safety.

Caños lavabo / Wash basin spout



Caño mural baño cuadrado
Square wall bath spout

- Ref.: 1674 45 - **Chrome**
- Ref.: 1674 41 - **Black**
- Ref.: 1674 51 - **Brushed Gold**
- Ref.: 1674 52 - **Brushed Metal**



NEW

Caño mural baño cilíndrico
Round wall bath spout

- Ref.: 1668 45 - **Chrome**
- Ref.: 1668 41 - **Black**
- Ref.: 1668 51 - **Brushed Gold**
- Ref.: 1668 52 - **Brushed Metal**



Caño mural baño fundido
Casted wall bath spout

Ref.: 1667 45



Caño mural tubo recto 16 cm
Wall-mounted pipe spout 16 cm
Ref.: 68911 45



Caño mural tubo recto 22 cm
Wall-mounted pipe spout 22 cm
Ref.: 68912 45



Caño mural tubo inclinado 20 cm
Wall-mounted sloping pipe spout 20 cm
Ref.: 68913 45

Caños lavabo / Wash basin spout



Caño mural tubo retro 20 cm
Wall-mounted retro pipe spout 20 cm
Ref.: 68914 45



Caño encimera recto tubo
Straight pipe spout
Ref.: 68915 45



Caño encimera cisne tubo
Swan neck pipe spout
Ref.: 100696 45



Caño encimera inclinado tubo
Sloping pipe spout
Ref.: 68917 45

Válvulas de desagüe/ Drain valves



NEW

Válvula universal click Luxe con y sin rebosadero

Luxe universal click pop-up waste with and without overflow

- Ref.: 100211 45 - **Chrome**
- Ref.: 100211 43 - **Bronze**
- Ref.: 100211 41 - **Black**
- Ref.: 100211 51 - **Brushed Gold**
- Ref.: 100211 52 - **Brushed Metal**



Tapa universal "Click remove"
"Click remove" universal cover

Ref.: 100202 45



NEW

Válvula universal click con y sin rebosadero

Universal click pop-up waste with and without overflow

Ref.: 100205 45



Válvula universal click Kenjo con y sin rebosadero
Kenjo universal click pop-up waste with and without overflow

Ref.: 100204 45



Válvula universal click lavabo y bidé click con rebosadero

Click pop-up waste for basin and bidet with overflow

Ref.: 100206 45



Válvula universal lavabo y bidé click
Click pop-up waste for basin and bidet

Ref.: 100207 45



NEW

Válvula universal click para bañera
Click pop-up waste for bath

- Ref.: 100208 45 - **Chrome**
- Ref.: Ref.: 100208 43 - **Bronze**



NEW

Válvula universal click lavabo y bidé click doble función
Double function click pop-up waste for basin and bidet

Ref.: 100209 45



NEW

Válvula universal click lavabo y bidé click doble función
Double function click pop-up waste for basin and bidet

Ref.: 100210 45



Válvula automática plástico 1 1/4"
1 1/4" plastic automatic valve

Ref.: 100200 45



Válvula automática metálica 1 1/4"
1 1/4" metallic automatic valve

Ref.: 100203 45

Sifones / Siphons



Sifón botella cuadrado para lavabo y bidé 1 1/4"
Square 1 1/4" bidet and wash-basin siphon
Ref.: 1621 07



Sifón botella redondo para lavabo y bidé 1 1/4"
Round 1 1/4" bidet and wash-basin siphon
● Ref.: 1622 07 - **Chrome**
● Ref.: 1626 41 - **Black**
● Ref.: 1626 51 - **Brushed Gold**
● Ref.: 1626 52 - **Brushed Meta**



Tubo alargo vertical sifón 1 1/4"
Vertical enlarge tube 1 1/4" siphon
● Ref.: 1632 00 - **Chrome**
● Ref.: 1648 41 - **Black**
● Ref.: 1648 51 - **Brushed Gold**
● Ref.: 1648 52 - **Brushed Meta**

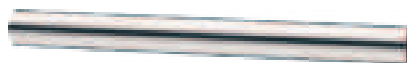

NEW

Tubo alargo horizontal sifón 1 1/4"
Horizontal enlarge tube 1 1/4" siphon
● Ref.: 1640 07 - **Chrome**
● Ref.: 1650 41 - **Black**
● Ref.: 1650 51 - **Brushed Gold**
● Ref.: 1650 52 - **Brushed Metal**

Reguladores de caudal

Flow regulator

Para duchas / For showers



Conector 1/2" con regulador caudal
1/2" Connector with flow regulator

Consumo litros x minuto
Consumption in litres x minute

Ref.: 9908 0300	3L
Ref.: 9908 0301	4L
Ref.: 9908 0302	5L
Ref.: 9908 0303	6L
Ref.: 9908 0304	8L
Ref.: 9908 0305	10L
Ref.: 9908 0306	12L
Ref.: 9908 0307	14L

Aireadores

Aerators

Aerators / For taps



NEW

Aireador M24x1 antical economizador
M24x1 Anti-lime economizer aerator

Consumo litros x minuto
Consumption in litres x minute

Ref.: 9908 0311	2L
Ref.: 9908 0312	4L
Ref.: 9908 0313	5L
Ref.: 9908 0314	6L
Ref.: 9908 0315	8L



Para instalaciones con baja presión, recomendamos los aireadores ref. 9908 0310 (M24X1) y 9908 0316 (H22X1), ofrecen alta sensación de confort con consumo de 5 litros a los 0,2 Bar.

For installations with very low pressure, we offer aerators ref. 9908 0310 (M24X1) and 9908 0316 (F22X1), that offer a great feeling of comfort with a consumption of 5 litres at 0.2 Bar.

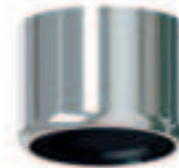

NEW

Aireador H22x1 antical economizador
F22x1 Anti-lime economizer aerator

Consumo litros x minuto
Consumption in litres x minute

Ref.: 9908 0317	2L
Ref.: 9908 0318	4L
Ref.: 9908 0319	5L
Ref.: 9908 0320	6L
Ref.: 9908 0321	8L

Aireador antical M24x1 baja presión
M24x1 Anti-lime low pressure aerator
Ref.: 9908 0310

Aireador antical H22x1 baja presión
F22x1 Anti-lime low pressure aerator
Ref.: 9908 0316

Ahorro de agua y energía

Water and energy saving

Ahora GENE BRE presenta su amplia gama de economizadores, tanto para baño como cocina.

Nuestros conectores con regulador de caudal para ducha y aireadores antical economizadores ideales para grifos, harán que tus instalaciones sean más eficientes en el consumo de agua y energía.

Consumo más sostenible

Gracias al sistema de regulación dinámica, la reducción se produce sea cual sea la presión del agua.

En los aireadores, su mezclado de agua con aire ofrece una gran sensación de confort, a la vez que se reduce el consumo, haciéndolo más eficiente y sostenible. Además, al reducir su caudal, también se ahorra energía en la fase de calentamiento del agua.



Ahorro de agua, hasta 20 litros minuto.
Water saving, up to 20 litres minute

Now GENE BRE presents its wide range of economizers, for both bathroom and kitchen.

Our connectors with flow regulator for showers, and antical economizing aerators ideal for taps, will make your installations more efficient in terms of water and energy consumption.

More sustainable consumption

Thanks to the dynamic regulation system, the reduction occurs whatever the water pressure.

In aerators, mixing water with air offers a great feeling of comfort, while reducing consumption, making it more efficient and sustainable. In addition, by reducing the flow, you also save energy in the water heating phase.

Los economizadores GENE BRE ayudan a conseguir las certificaciones más exigentes.
The GENE BRE economizers help achieve the most demanding certifications.

Filtros / Filters



Kit de clorador
Dechlorinator kit
Ref.: FT00



NEW

Kit de ultrafiltración
Ultrafiltration kit
Ref.: FT01



Filtro de ultrafiltración
Ultrafiltration filter
Ref.: FT91



Filtro de cloración
Dechlorinator filter
Ref.: FT92

Accesorios / Accessories



Conjunto florón y excéntricas gigantes
Giant scutcheon and eccentric set
Ref.: 100122 45

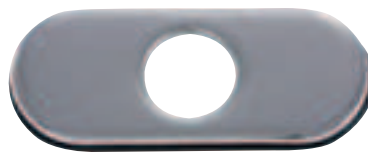

Placa adaptadora 4"
4" adaptor plate
Ref.: P130



Placa adaptadora 8"
8" adaptor plate
Ref.: P200

Accesorios para la instalación

Installation accessories

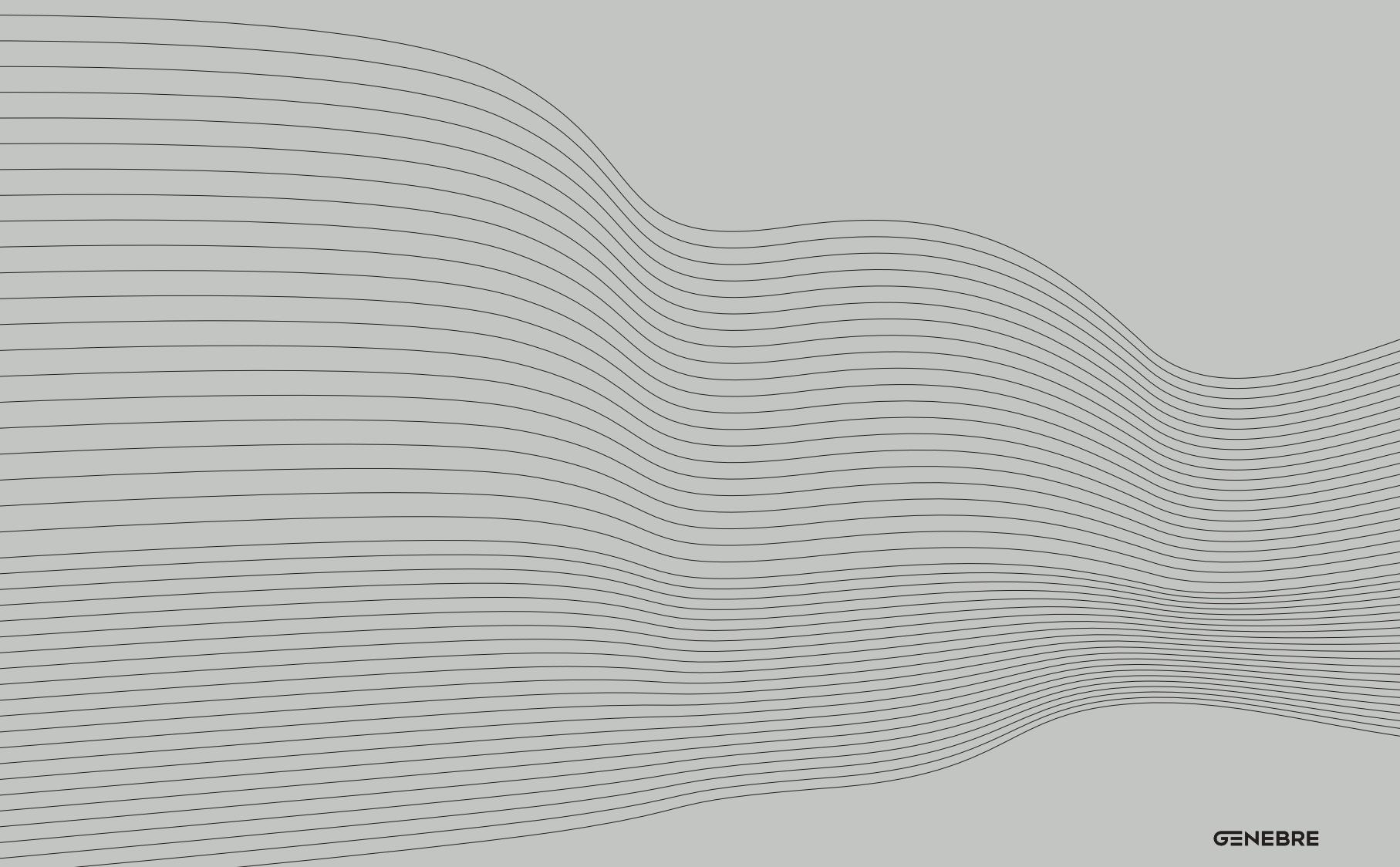

Accesorios para la instalación / Installation accessories



NEW

Caja instalacion GEBOX 115
Installation box 115 GEBOX
Ref.: 115BOX



NEW

Caja instalacion GEBOX 116
Installation box 116 GEBOX
Ref.: 116BOX



NEW

Caja instalacion GEBOX 118
Installation box 118 GEBOX
Ref.: 118BOX



NEW

Inversor largo
Long diverter
Ref.: EXT0001



NEW

Inversor largo negro
Black long diverter
Ref.: EXT0002



NEW

Kit extensor cartucho 40mm
Extension kit 40mm cartridge
Ref.: EXT0003



NEW

Kit extensión inversor cerámico
Extension kit ceramic diverter
Ref.: EXT0004



NEW

Kit extensión cartucho 35mm
Extension kit 35mm cartridge
Ref.: EXT0005



NEW

Kit extensión cartucho negro 35mm
Blanck extension kit 35mm cartridge
Ref.: EXT0006

Empotrados con caja de instalación

Built-in with installation box

Empotrados con caja de instalación / Built-in with installation box



NEW

Monomando empotrado 1 vía GEBOX
GEBOX Built-in single lever shower mixer
Ref.: B115 40 10



NEW

Monomando empotrado 2 vías GEBOX
GEBOX Built-in single lever mixer 2-way
Ref.: B117 40 10



NEW

Monomando empotrado 3 vías GEBOX
GEBOX Built-in single lever mixer 3-way
Ref.: B118 40 10



NEW

Kit Placa redonda para empotrada
Built-in round plate Kit
● Ref.: KPB115 40 - Chrome



NEW

Kit Placa ducha empotrada
Built-in shower mixer plate Kit
● Ref.: KPC115 40 45 - Chrome



NEW

Kit Placa ducha empotrada
Built-in shower mixer plate Kit
● Ref.: KPT115 40 45 - Chrome



NEW

Kit Placa redonda empotrada 2 vías
Built-in 2 way round plate Kit
● Ref.: KPB117 40 45 - Chrome



NEW

Kit Placa empotrada 2 vías
Built-in 2 way plate Kit
● Ref.: KPC117 40 45 - Chrome



NEW

Kit Placa rectangular empotrada 2 vías
Built-in 2 way rectangular plate Ki
● Ref.: KPT117 40 45 - Chrome



NEW

Kit Placa redonda empotrada 3 vías
Built-in 3 way round plate Kit
● Ref.: KPB118 40 45 - Chrome



NEW

Kit Placa empotrada 3 vías
Built-in 3 way plate Ki
● Ref.: KPC118 40 45 - Chrome



NEW

Kit Placa rectangular empotrada 3 vías
Built-in 3 way rectangular plate Kit
● Ref.: KPT118 40 45 - Chrome



¡Enlaza al video y conoce mejor nuestro sistema GEBOX!

Link to the video and learn about our GEBOX system!



NEW

Kit Placa ducha empotrada Negro
Black Built-in shower mixer plate Kit
● Ref.: KPC115 40 41 - **Black**



NEW

Kit Placa empotrada 2 vías Negro
Black Built-in 2 way plate Kit
● Ref.: KPC117 40 41 - **Black**



NEW

Kit Placa empotrada 3 vías Negro
Black Built-in 3 way plate Kit
● Ref.: KPC118 40 41 - **Black**



NEW

Maneta K8
K8 lever
● Ref.: 100001 28 45 - **Chrome**



NEW

Maneta Ge2
Ge2 lever
● Ref.: 100001 22 45 - **Chrome**



NEW

Maneta Tau
Tau lever
● Ref.: 100001 18 45 - **Chrome**



NEW

Maneta Tau 2
Tau 2 lever
● Ref.: 100001 29 45 - **Chrome**



NEW

Maneta Koral
Koral lever
● Ref.: 100001 32 45 - **Chrome**



NEW

Maneta Kode corta
Short Kode lever
● Ref.: 100001 31 45 - **Chrome**

Packaging

Packaging con diseño e identidad visual fácilmente identificable

Packaging with easily identifiable design and visual identity



El packaging de los productos Genebre incluye toda la información necesaria para identificar el producto, además también disponen de QR para ampliar información si se desea.

The packaging of Genebre products includes all the information necessary to identify the product, and in many cases a QR can also be found to provide more information.

Punto de venta

Point of sale

Expositores para mayor visibilidad en el punto de venta

Displays for greater visibility at the point of sale



Los expositores Genebre están formulados para mayor visibilidad en el espacio de venta. De este modo se consigue impulsar y reforzar la identidad corporativa de nuestros productos y mejorar la experiencia de compra.

Genebre displays are formulated for greater visibility in the sales space. In this way, it is possible to promote and reinforce the corporate identity of our products and improve the purchasing experience.

Consultar condiciones para soporte en el punto de venta en

Consult conditions for support at the point of sale at

comunicacion@genebre.es

Recambios

Spare parts

La importancia de las piezas.

Es importante disponer de las piezas de recambio para mantener el baño siempre en perfecto estado aunque pase el tiempo. Por eso, contamos con una gran colección de piezas exclusivas con la misma calidad de siempre.

The importance of the parts.

It is important to have the spare parts available to always keep the bathroom in a perfect state through the pass of time. Therefore, we have a large collection of exclusive pieces with the same quality as always.



Maneta
Handle

Ref.:	Descripción Description
100001 05 45	Maneta Sara Sara lever
100001 08 45	Maneta Kode Kode lever
100001 16 45	Maneta Klip Klip lever
100001 18 45	Maneta Tau Tau lever
100001 19 45	Maneta Oslo Oslo lever
100001 22 45	Maneta GE2 GE2 lever
100001 26 45	Maneta Kenjo Kenjo lever
100001 28 45	Maneta K8 K8 lever
100001 29 45	Maneta Tau 2 Tau 2 lever
100001 31 45	Maneta Kode corta Short Kode lever
100001 32 41	Maneta Koral Negra Black Koral lever
100001 32 45	Maneta Koral Koral lever
100001 33 45	Maneta GE2 corta Short GE2 lever
100001 34 41	Maneta Kloe Ø25 Kloe lever Ø25
100001 34 45	Maneta Kloe Ø25 Kloe lever Ø25
100001 34 51	Maneta Kloe Ø25 Kloe lever Ø25
100001 34 52	Maneta Kloe Ø25 Kloe lever Ø25
100001F 16 45	Maneta Kelogic Kelogic lever
100001F 19 45	Maneta Oslo apertura en frio Cold start Oslo lever
100001F 28 45	Maneta K8 apertura en frio Cold start K8 lever
100001F 32 45	Maneta Koral apertura en frio Cold start Koral lever
100001R 16 45	Maneta Kelogic marcado vertical Vertical marked Kelogic lever
100001R 19 45	Maneta Oslo marcado frio vertical Vertical marked cold Oslo lever
100001T 32 45	Maneta columna Koral Koral column lever
100001T 32 41	Maneta 2p Koral Negra Black 2p Koral lever
100001V 05 45	Maneta Sara marcado vertical Vertical marked Sara lever
100001V 16 45	Maneta Klip marcado vertical Vertical marked Klip lever
100001V 18 41	Maneta Tau marcado vertical Negra Black marked Tau lever
100001V 18 44	Maneta Tau marcado vertical a.Inox SS F. marked Tau lever
100001V 18 45	Maneta Tau marcado vertical Vertical marked Tau lever
100001V 18 60	Maneta Tau Inox marcado vertical Vertical marked Tau Inox lever
100001V 19 45	Maneta Oslo marcado vertical Vertical marked Oslo lever
100001V 28 45	Maneta K8 marcado vertical Vertical marked K8 lever
100001V 32 45	Maneta Koral marcado vertical Vertical marked Koral lever
100001V 33 45	Maneta GE2 corta marcado vertical Vertical marked short GE2 lever
100001V 37 45	Maneta Tau 35 marcado vertical Vertical marked Tau 35 lever
100001V 39 43	Maneta New Regent marcado vertical bronce Vertical marked New Regent bronze lever
100001V 39 45	Maneta New Regent marcado vertical Vertical marked New Regent lever
100001V 40 60	Maneta Flat Flat handle
100002 34 41	Maneta Kloe Ø35 Kloe lever Ø35
100002 34 45	Maneta Kloe Ø35 Kloe lever Ø35



Maneta
Handle

Ref.:	Descripción Description
100002 34 51	Maneta Kloe Ø35 Kloe lever Ø35
100002 34 52	Maneta Kloe Ø35 Kloe lever Ø35
9908 0039	Maneta FRT65401 FRT65401 lever
9908 0040	Maneta FRT65402 FRT65402 lever
9908 0041	Maneta FRV61205 FRV61205 lever
9908 0045	Maneta FRK FRK lever
9908 0218	Maneta columna Tau D35 D 35 Tau column handle
9908 0219	Maneta columna Tau 2 D35 D35 Tau 2 column handle
9908 0222	Maneta para FRV61207 Blanca White Lever for FRV61207
9908 0225	Maneta para FRV61207 Negra Black Lever for FRV61207
9908 0235	Maneta inversor columna Oslo Oslo column diverter lever
9908 0241	Maneta FRT65401 Blanca White FRT65401 lever
9908 0243	Maneta 65403 18 41 66 65403 18 41 66 lever
9908 0251	Maneta para 65212 18 45 66 Lever for 65212 18 45 66
9908 0278	Maneta Oslo Negra Black Oslo lever
9908 0370	Maneta inversor columna Oslo Negro Black Oslo column diverter lever
9908 0389	Maneta FRT65401 a. INOX F. SS FRT65401 lever
9908 0392	Maneta para FRV61207 a. INOX F. SS Lever for FRV61207
9908 0395	Maneta FRV61208 Lever for FRV61208
9908 0398	Maneta FRV61208 Negra Black Lever for FRV61208
9908 0438	Maneta FRV61208 a. INOX F. SS Lever for FRV61208
9908 0455	Maneta mezclador sanitario Lever sanitary mixer
9908 0459	Maneta mezclador sanitario Negra Black sanitary mixer lever
9908 0469	Maneta mezclador sanitario Lever sanitary mixer
9908 0470	Maneta mezclador sanitario Lever sanitary mixer



Florón
Scutcheon

Ref.:	Descripción Description
9908 0297	Cobertor Inversor Negro Black Diverter Cover
9908 0447	Cobertor Inversor Diverter Cover
68988 18	Kit volantes columnas termostáticas Tau Tau thermostatic column handle set
68989 26	Kit volantes columnas termostáticas Kenjo Kenjo thermostatic column handle set
68991 14	Kit volantes termostática Tau Tau thermostatic mixer handle set
68992 26	Kit volantes termostáticas Kenjo Kenjo thermostatic mixer handle set
68994 14	Kit volantes termostática Thermostatic mixer handle set
68998 07 45	Volante Kalo Kalo handle
68998 08 45	Volante Kross Kross handle
68998 09 43	Volante Regent bronce Bronze Regent handle
68998 09 45	Volante Regent Regent handle
68998 11 45	Volante Gamma Gamma handle
68998 12 45	Volante Ixo Ixo handle
68998 28 45	Volante Office Office handle
68998 30 45	Volante Tau Tau handle
68998 31 45	Volante osmosis Osmosis handle
9908 0056	Kit volante termostatica empotrada 2 y 3 vías Built-in 2 and 3 ways thermostatic handle set
9908 0100	Cobertor cartucho termostático Thermostatic cartridge cover
9908 0101	Volante cartucho termostático Thermostatic cartridge handle
9908 0103	Soporte florón para 568120 45 Scutcheon support for 568120 45
9908 0205	Volante inversor set redondo Round set diverter handle
9908 0215	Volante inversor set cuadrado Square set diverter handle
9908 0217	Volante inversor columna redonda Round column diverter handle
9908 0220	Kit volantes columnas monomando cuadradas Square single handle column handle set
9908 0234	Volante inversor set Oslo Oslo set diverter handle
9908 0376	Volante inversor set Oslo Negro Black Oslo set diverter handle
9908 0239	Volante montura columna Oslo Oslo column headwork handle
9908 0373	Volante inversor columna Oslo Negro Black Oslo column diverter handle
9908 0240	Volante cartucho columna Oslo Oslo column cartridge handle
9908 0272	Volante grifo de 1 vía Handle for one way tap
9908 0451	Volante llave de paso Stopcock handle
9908 0443	Volante llave de paso Negro Black Stopcock handle
68998 31 41	Volante osmosis Negro Black Osmosis handle
68998 31 44	Volante osmosis a.Inox SS F. Osmosis handle
68998 30 41	Volante inversor cerámico Negro Black ceramic diverter handle
DH0001 45	Volante inversor Diverter handle
DH0001 41	Volante inversor Negro Black Diverter handle
9908 0481	Volante llave de paso Stopcock handle
9908 0482	Volante llave de paso Stopcock handle
9908 0103	Soporte florón para 568120 45 Scutcheon support for 568120 45



Florón
Scutcheon

Ref.:	Descripción Description
9908 0297	Cobertor Inversor Negro Black Diverter Cover
9908 0447	Cobertor Inversor Diverter Cover
68988 18	Kit volantes columnas termostáticas Tau Tau thermostatic column handle set
68989 26	Kit volantes columnas termostáticas Kenjo Kenjo thermostatic column handle set
68991 14	Kit volantes termostática Tau Tau thermostatic mixer handle set
68992 26	Kit volantes termostáticas Kenjo Kenjo thermostatic mixer handle set
68994 14	Kit volantes termostática Thermostatic mixer handle set
68998 07 45	Volante Kalo Kalo handle
68998 08 45	Volante Kross Kross handle
68998 09 43	Volante Regent bronce Bronze Regent handle
68998 09 45	Volante Regent Regent handle
68998 11 45	Volante Gamma Gamma handle
68998 12 45	Volante Ixo Ixo handle
68998 28 45	Volante Office Office handle
68998 30 45	Volante Tau Tau handle
68998 31 45	Volante osmosis Osmosis handle
9908 0056	Kit volante termostática empotrada 2 y 3 vías Built-in 2 and 3 ways thermostatic handle set
9908 0100	Cobertor cartucho termostático Thermostatic cartridge cover
9908 0101	Volante cartucho termostático Thermostatic cartridge handle
9908 0103	Soporte florón para 568120 45 Scutcheon support for 568120 45
9908 0205	Volante inversor set redondo Round set diverter handle
9908 0215	Volante inversor set cuadrado Square set diverter handle
9908 0217	Volante inversor columna redonda Round column diverter handle
9908 0220	Kit volantes columnas monomando cuadradas Square single handle column handle set
9908 0234	Volante inversor set Oslo Oslo set diverter handle
9908 0376	Volante inversor set Oslo Negro Black Oslo set diverter handle
9908 0239	Volante montura columna Oslo Oslo column headwork handle
9908 0373	Volante inversor columna Oslo Negro Black Oslo column diverter handle
9908 0240	Volante cartucho columna Oslo Oslo column cartridge handle
9908 0272	Volante grifo de 1 vía Handle for one way tap
9908 0451	Volante llave de paso Stopcock handle
9908 0443	Volante llave de paso Negro Black Stopcock handle
68998 31 41	Volante osmosis Negro Black Osmosis handle
68998 31 44	Volante osmosis a.Inox SS F. Osmosis handle
68998 30 41	Volante inversor cerámico Negro Black ceramic diverter handle
DH0001 45	Volante inversor Diverter handle
DH0001 41	Volante inversor Negro Black Diverter handle
9908 0481	Volante llave de paso Stopcock handle
9908 0482	Volante llave de paso Stopcock handle
9908 0103	Soporte florón para 568120 45 Scutcheon support for 568120 45



Florón
Scutcheon

Ref.:	Descripción Description
9908 0102	Florón para 568120 45 Scutcheon for 568120 45
9908 0379	65200 19 45 66 Base Base to 65200 19 45 66
9908 0386	Florón deslizante Sliding cover
9908 0446	Cobertor Cartucho D40 D40 Cartridge Cover
9908 0387	Cobertor fijo Fix cover
9908 0447	Cobertor Inversor Diverter Cover
9908 0445	Cobertor D40 D40 Cover
9908 0293	Cobertor D40 Negro Black D40 Cover
9908 0295	Cobertor Cartucho D40 Negro Black D40 Cartridge Cover
9908 0297	Cobertor Inversor Negro Black Diverter Cover



Duchas
Shower

100131 60	Mango ducha inoxidable SS hand shower
100175 45 00	Mango de ducha E1 jet E1 jet handshower
100187 45	Aireador extraíble Pull-out aerator
100190 45	Mango ducha de fregadera extraíble Pull-out sink tap sprayer
100196 43 00	Mango de ducha New Regent bronce New Regent bronze hand shower
100196 45 00	Mango de ducha New Regent cromo New Regent chromed hand shower
100197 45 00	Mango de ducha C1 jet C1 jet handshower
100199 45	Mango ducha extraíble para FRV61205 Pull-out FRV61205 sink tap sprayer
100252 45	Mango extraíble fregadera Pull-out sink tap sprayer
100696 45	Kit ducha sanitaria Sanitary shower kit
9908 0223	Aireador extraíble Negro Black Pull-out aerator
9908 0214	Aireador extraíble Blanco White Pull-out aerator
9908 0246	Mango de ducha Handshower
9908 0248	Mango de ducha Handshower
9908 0255	Mango Ducha para 65212 18 45 66 Hand shower for 65212 18 45 66
9908 0260	Aireador extraíble Pull-out aerator
9908 0325	Mango de ducha Negro Black Handshower
9908 0390	Aireador extraíble a.Inox SS F. Pull-out aerator
DXK3 45	Mango de ducha K3 jets K3 jets handshower
DXL3 45	Mango de ducha L3 jets L3 jets handshower
DXL3 41	Mango de ducha L3 jets L3 jets handshower
DXL3 51	Mango de ducha L3 jets L3 jets handshower
DXL3 52	Mango de ducha L3 jets L3 jets handshower
DXT5 45	Mango de ducha T5 jets T5 jets handshower
R63112 26	Rociador cuadrado 22 cm Square shower head 22 cm
R65112 18	Rociador redondo 22 cm Round shower head Ø 22 cm
R65112 19	Rociador D22 Oslo Oslo D22 shower head
R65112 41	Rociador D22 Oslo Black Oslo Black D22 shower head
9908 0396	Mango ducha extraíble para FRV61208 Pull-out FRV61208 sink tap sprayer
9908 0399	Mango ducha extraíble para FRV61208 Negra Black Pull-out FRV61208 sink tap sprayer



Duchas
Shower



Flexo
Flexible hose

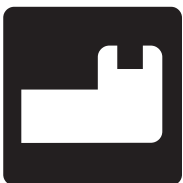

Soporte ducha fijos
Fixed shower holders

Ref.:	Descripción Description
9908 0435	Mango ducha extraíble para FRV61208 Blanca White Pull-out FRV61208 sink tap sprayer
9908 0439	Mango ducha extraíble para FRV61208 a. INOX F. SS Pull-out FRV61208 sink tap sprayer
DB142 45	Ducha bidet con transmision Shower bidet mixer with diverter
DB142 41	Ducha bidet con transmision Shower bidet mixer with diverter
DB142 51	Ducha bidet con transmision Shower bidet mixer with diverter
DB142 52	Ducha bidet con transmision Shower bidet mixer with diverter
100135 43 00	Flexo H 1/2" - H 1/2" bronce 1,7 m F 1/2" - F 1/2" bronze 1.7 m flexible hose
100135 60 00	Flexo H 1/2" - H 1/2" 1,70 m inoxidable F 1/2" - F 1/2" Stainless steel flexible hose 1.70 m
100135 41 00	Flexo H 1/2" - H 1/2" 1,70 m inoxidable F 1/2" - F 1/2" Stainless steel flexible hose 1.70 m
100135 51 00	Flexo H 1/2" - H 1/2" 1,70 m inoxidable F 1/2" - F 1/2" Stainless steel flexible hose 1.70 m
100135 52 00	Flexo H 1/2" - H 1/2" 1,70 m inoxidable F 1/2" - F 1/2" Stainless steel flexible hose 1.70 m
100140 30	Flexo H 1/2" - H 1/2" 1,70 m. PVC antirrotura F 1/2" - F 1/2" PVC flexible hose 1.70 m anti-breaking
100141 45	Flexo H 1/2" - H 1/2" 1,20 m inoxidable F 1/2" - F 1/2" Stainless steel flexible hose 1.20 m
100143 45	Flexo flegadera 15 x 1 - H 1/2" 1,15 m 15 x 1 - F 1/2" 1,15 m pull-out sink tap hose
100143 60	Flexo fregadera para 65211 18 60 66 Sink tap hose for 65211 18 60 66
9908 0080	Flexo para 65207 18 60 66 Flexible hose for 65207 18 60 66
9908 0203	Flexo H 1/2" - H 1/2" 0,6 m cromado F 1/2" - F 1/2" 0.6 m chromed flexible hose
9908 0377	Flexo H 1/2" - H 1/2" 0,6 m Negro F 1/2" - F 1/2" 0.6 m Black flexible hose
9908 0206	Flexo H 1/2" - H 1/2" 1,5 m cromado F 1/2" - F 1/2" 1.5 m chromed flexible hose
9908 0368	Flexo H 1/2" - H 1/2" 1,5 m Negro F 1/2" - F 1/2" 1.5 m Black flexible hose
9908 0213	Flexo para FRV61207 Flexible hose for FRV61207
9908 0393	Flexo para FRV61207 a. INOX F. SS Flexible hose for FRV61207
9908 0256	Flexo para 65212 18 45 66 Flexible hose for 65212 18 45 66
9908 0258	Flexo para 65219 18 45 66 Flexible hose for 65219 18 45 66
9908 0262	Flexo para FRV61206 Flexible hose for FRV61206
100141 51	Flexo H 1/2" - H 1/2" 1,20 m inoxidable F 1/2" - F 1/2" Stainless steel flexible hose 1.20 m
100141 52	Flexo H 1/2" - H 1/2" 1,20 m inoxidable F 1/2" - F 1/2" Stainless steel flexible hose 1.20 m
100067 45	Soporte ducha GE2 GE2 shower holder
100149 45	Soporte ducha Kenjo Kenjo shower holder
100152 45 00	Soporte ducha Shower holder
100153 45	Soporte ducha cilíndrico Cylindrical shower holder
100153 41	Soporte ducha cilíndrico Cylindrical shower holder
100153 51	Soporte ducha cilíndrico Cylindrical shower holder
100153 52	Soporte ducha cilíndrico Cylindrical shower holder
1647 43	Soporte ducha Clásico bronce Classic bronze shower holder
1647 45	Soporte ducha Cásico Classic shower holder
9908 0172	Soporte superior set redondo Upper holder of round set
9908 0173	Soporte superior set cuadrado Upper holder of square set
9908 0226	Soporte columna redonda Round column holder



Soporte ducha fijos
Fixed shower holders

Ref.:	Descripción Description
9908 0227	Soporte columna cuadrada Square column holder
9908 0232	Soporte columna Oslo Oslo column holder
9908 0366	Soporte columna Oslo Negro Black Oslo column holder
9908 0245	Soporte deslizante columna Koral Koral column sliding shower holder
9908 0254	Soporte ducha para 65212 18 45 66 Shower holder for 65212 18 45 66
9908 0259	Soporte ducha para 65219 18 45 66 Shower holder for 65219 18 45 66
9908 0286	Soporte ducha Negro black Shower holder
9908 0457	Soporte mezclador sanitario Sanitary mixer shower holder
9908 0461	Soporte mezclador sanitario Negro Black sanitary mixer shower holder
9908 0475	Soporte mezclador sanitario Sanitary mixer shower holder
9908 0476	Soporte mezclador sanitario Sanitary mixer shower holder
9908 0485	Soporte Ducha Shower holder
1634 04	Soporte de ducha cilíndrico con toma 1/2" Cylindrical shower holder with 1/2" connector



Soporte ducha deslizante
Sliding shower holders

9908 0076	Soporte deslizante ducha para 1636 45 Sliding shower holder for 1636 45
9908 0077	Soporte deslizante ducha para 1637 45 Sliding shower holder for 1637 45
9908 0078	Soporte deslizante ducha para 1638 45 Sliding shower holder for 1638 45
9908 0079	Soporte deslizante ducha para 1639 45 Sliding shower holder for 1639 45
9908 0201	Soporte deslizante columna redonda Round column shower holder
9908 0211	Soporte deslizante columna cuadrada Square column shower holder
9908 0231	Soporte deslizante columna Oslo Oslo column sliding shower holder
9908 0367	Soporte deslizante columna Oslo Negro Black Oslo column sliding shower holder
9908 0366	Soporte columna Oslo Negro Black Oslo column holder
9908 0442	Soporte deslizante ducha Negro Black sliding shower holder
9908 0477	Soporte deslizante ducha Sliding shower holder
9908 0478	Soporte deslizante ducha Sliding shower holder



Caño
Spout

Ref.:	Descripción Description
68901 45	Caño alto tubo 18 cm High tube spout 18 cm
68902 45	Caño alto tubo 24 cm High tube spout 24 cm
68903 45	Caño tubo vertical Swan neck spout
68904 45	Caño bajo tubo 24 cm Low tube spout 24 cm
68911 45	Caño mural tubo recto 16 cm Wall-mounted pipe spout 16 cm
68912 45	Caño mural tubo recto 22 cm Wall-mounted pipe spout 22 cm
68913 45	Caño mural tubo inclinado 20 cm Wall-mounted sloping pipe spout 20 cm
68914 45	Caño mural tubo retro 20 cm Wall-mounted retro pipe spout 20 cm
68915 45	Caño encimera recto tubo Straight pipe spout
68916 45	Caño encimera cisne tubo Swan neck pipe spout
68917 45	Caño encimera inclinado tubo Sloping pipe spout
68918 41	Caño mural tubo recto 16 cm D20 D20 wall mounted pipe spout 16 cm
68918 45	Caño mural tubo recto 16 cm D20 D20 wall mounted pipe spout 16 cm
68918 51	Caño mural tubo recto 16 cm D20 D20 wall mounted pipe spout 16 cm
68918 52	Caño mural tubo recto 16 cm D20 D20 wall mounted pipe spout 16 cm
68919 41	Caño mural tubo recto 22cm D20 D20 wall mounted pipe spout 22 cm
68919 45	Caño mural tubo recto 22cm D20 D20 wall mounted pipe spout 22 cm
68919 51	Caño mural tubo recto 22cm D20 D20 wall mounted pipe spout 22 cm
68919 52	Caño mural tubo recto 22cm D20 D20 wall mounted pipe spout 22 cm
68922 45	Caño inferior elevado High lower spout
68924 41	Caño mural tubo recto 16 cm Negro Black Wall mounted pipe spout 16 cm
68924 45	Caño mural tubo recto 16 cm Wall mounted pipe spout 16 cm
68925 41	Caño mural tubo recto 22 cm Negro Black Wall mounted pipe spout 22 cm
68925 45	Caño mural tubo recto 22 cm Wall mounted pipe spout 22 cm
68926 45	Caño mural rectangular 16 cm Wall mounted rectangular pipe spout 16 cm
68927 45	Caño mural rectangular 22 cm Wall mounted rectangular pipe spout 22 cm
68928 45	Caño mural tubo recto 16 cm D20 D 20 Wall mounted pipe spout 16 cm
68929 45	Caño mural tubo recto 22 cm D20 D 20 Wall mounted pipe spout 22 cm
9908 0253	Caño para 65212 18 45 66 Spout for 65212 18 45 66
9908 0290	Caño mural tubo recto 16 cm D20 Negro Black D20 wall mounted pipe spout 16 cm
9908 0291	Caño mural tubo recto 22 cm D20 Negro Black D20 wall mounted pipe spout 22 cm
9908 0382	Caño conformado vertical Vertical tube spout
9908 0383	Caño conformado Tube spout
9908 0384	Caño conformado corto Short tube spout
1699 45 00	Brazo pared redondo 12 cm Round wall arm 12 cm



**Atomizador
(Aireador)**
Aerator

Ref.:	Descripción Description
100025 41	Aireador M16,5x1 antivandálico 5 Litros M16,5x1 Antivandal aerator 5 liters
100025 45	Aireador M16,5x1 antivandálico 5 Litros M16,5x1 Antivandal aerator 5 liters
100025 51	Aireador M16,5x1 antivandálico 5 Litros M16,5x1 Antivandal aerator 5 liters
100025 52	Aireador M16,5x1 antivandálico 5 Litros M16,5x1 Antivandal aerator 5 liters
100065 41	Aireador H18x1 antical economizador 5 litros F18x1 Anti-lime economizer aerator 5 liters
100065 45	Aireador H18x1 antical economizador 5 litros F18x1 Anti-lime economizer aerator 5 liters
100065 51	Aireador H18x1 antical economizador 5 litros F18x1 Anti-lime economizer aerator 5 liters
100065 52	Aireador H18x1 antical economizador 5 litros F18x1 Anti-lime economizer aerator 5 liters
100066 45	Aireador M18 x 1 antical M18 x 1 anti-lime aerator
100072 45	Aireador M24 x 1 antical antivandálico M24 x 1 Antivandal anti-lime aerator
100073 43	Aireador H22x1 antical bronce retro F22x1 bronze anti-lime retro aerator
100073 45	Aireador H22x1 antical retro F22x1 anti-lime retro aerator
100074 45	Aireador M24x1 antical economizador 8,5 litros M24x1 Economizer anti-lime 8.5 liters aerator
100078 45	Aireador H22 x 1 antical economizador (blister 2 u.) F22 x 1 Economizer anti-lime aerator (blister 2 u.)
100079 41	Aireador M12x1 antical con rótula M12x1 anti-lime aerator w/kneecap
100079 45	Aireador M12x1 antical con rótula M12x1 anti-lime aerator w/kneecap
100079 51	Aireador M12x1 antical con rótula M12x1 anti-lime aerator w/kneecap
100079 52	Aireador M12x1 antical con rótula M12x1 anti-lime aerator w/kneecap
100080 45	Aireador para 65203 18 45 66 65203 18 45 66 aerator
100082 45	Aireador 2 salidas antical Double flow anti-lime aerator
100082 41	Aireador 2 salidas antical Negro Black Double flow anti-lime aerator
100082 44	Aireador 2 salidas antical a.Inox SS F. Double flow anti-lime aerator
100083 41	Aireador M28x1 antical Negro Black M28x1 anti-lime aerator
100083 43	Aireador M28x1 antical bronce M28x1 anti-lime bronze aerator
100083 45	Aireador M28x1 antical M28x1 anti-lime aerator
100085 41	Aireador M24x1 antical M24x1 anti-lime aerator
100085 43	Aireador M24x1 antical bronce M24x1 anti-lime bronze aerator
100085 45	Aireador M24x1 antical M24x1 anti-lime aerator
100085 51	Aireador M24x1 antical M24x1 anti-lime aerator
100085 52	Aireador M24x1 antical M24x1 anti-lime aerator
100086 43	Aireador M24x1 antical con rótula bronce M24x1 bronze anti-lime aerator w/ kneecap
100086 45	Aireador M24 x 1 antical con rótula M24 x 1 anti-lime aerator w/ kneecap
100088 45	Aireador H22x1 antical F22x1 anti-lime aerator
100089 45	Aireador H18 x 1 antical F18 x 1 aerator anti-lime
9908 0026	Aireador para caño rectangular Rectangular spout aerator
9908 0043	Aireador para 65203 18 60 66 65203 18 60 66 aerator
9908 0044	Aireador para 65208 18 60 66 65208 18 60 66 aerator
9908 0216	Aireador M24x1 antical Blanco White M24x1 anti-lime aerator
9908 0242	Aireador H18x1 antical Blanco White F18x1 anti-lime aerator
9908 0244	Aireador H18x1 antical Negro Black F18x1 anti-lime aerator
9908 0267	Aireador antivandálico orientable Antivandal orientable aerator



**Atomizador
(Aireador)**
Aerator

Ref.:	Descripción Description
9908 0268	Aireador antivandálico Antivandal aerator
9908 0279	Aireador M18x1 antical M18x1 anti-lime aerator
9908 0281	Aireador M24x1 antical con rótula Negro Black M24x1 anti-lime aerator w/kneecap
9908 0322	Aireador H22x1 antical Negro Black F22x1 anti-lime aerator
9908 0351	Aireador H18x1 antical INOX SS F18X1 anti-lime aerator
9908 0378	Aireador H28x1 antical Negro Black F28X1 ant-lime aerator
9908 0388	Aireador H18x1 antical a. INOX F. SS F18x1 anti-lime aerator
9908 0391	Aireador M24X1 antical a. INOX F. SS M24X1 anti-lime aerator
9908 0433	Aireador H22x1 antical F22x1 anti-lime aerator
9908 0434	Aireador M18x1 antical economizador 5 litros M18x1 anti-lime economizer aerator 5 liters
9908 0479	Aireador H28x1 antical F28X1 ant-lime aerator
9908 0480	Aireador H28x1 antical F28X1 ant-lime aerator
9908 0486	Aireador H28x1 antical F28X1 ant-lime aerator



Cartucho
Cartridge

100036	Cartucho cerámico D35 salida libre 2 posiciones 2 Positions free flow D35 ceramic cartridge
100037	Cartucho termostático Thermostatic mixer cartridge
100042	Cartucho cerámico D25 convencional 1 agua 1 water conventional D25 ceramic cartridge
100044	Cartucho cerámico D25 convencional Conventional D25 ceramic cartridge
100045	Cartucho cerámico D40 convencional 2 posiciones 2 positions conventional D40 ceramic cartridge
100046	Cartucho cerámico progresivo Progressive ceramic cartridge
100047	Cartucho termóstatico D24 D24 thermostatic cartridge
100048	Cartucho cerámico D40 salida libre 2 posiciones 2 positions free flow D40 ceramic cartridge
100049	Cartucho cerámico D40 convencional Conventional D40 ceramic cartridge
100051	Cartucho cerámico D40 salida libre Free flow D40 ceramic cartridge
100053	Cartucho cerámico D35 convencional Conventional D35 ceramic cartridge
100054	Cartucho cerámico D35 salida libre Free flow D35 ceramic cartridge
100058	Cartucho cerámico 2 vias 2-way ceramic cartridge
100064	Cartucho cerámico D40 junta superior salida libre 2 posiciones 2 positions free flow D40 ceramic cartridge upper gasket
9908 0051	Cartucho termostático empotrada Built-in tap thermostatic mixer cartridge
9908 0332	Cartucho cerámico D35 apertura frio Cold start D35 ceramic cartridge
9908 0333	Cartucho cerámico D40 apertura frio Cold start D40 ceramic cartridge
9908 0374	Cartucho termóstatico D24 Negro Black D24 thermostatic cartridge
9908 0452	Placa llave de paso Stopcock plate
9908 0467	Cartucho cerámico D25 junta superior salida libre Free flow D25 ceramic cartridge upper gasket



Montura
Headwork

Ref.:	Descripción Description
67895 45	Montura cerámica larga Ceramic long headwork
67896 45	Montura convencional larga Conventional long headwork
67897 45	Montura cerámica apertura derecha Clockwise opening ceramic headwork
67898 45	Montura cerámica larga apertura derecha Clockwise opening long ceramic headwork
67995 14	Montura cerámica termostática Thermostatic ceramic headwork
67997 45	Montura cerámica agua filtrada apertura derecha Clockwise opening filtered water ceramic headwork
67998 45	Montura cerámica agua filtrada Ceramic headwork filtered water
68995 09	Montura cerámica Ceramic headwork
68995 11	Montura convencional Conventional headwork
9908 0238	Montura cerámica para termostática Oslo Oslo thermostatic ceramic headwork
9908 0450	Montura cerámica para llave de paso 1/2" 1/2" stopcock ceramic headwork
9908 0454	Montura cerámica para llave de paso 3/4" 3/4" stopcock ceramic headwork



Inversor
Diverter

100069	Inversor cerámico columna termostática Thermostatic column ceramic diverter
100117 45	Inversor compacto Oslo Oslo compact diverter
100157 45	Inversor Kelogic Kelogic diverter
100158 45	Inversor termostático Kenjo Kenjo thermostatic diverter
100160 41	Inversor latón Negro Black brass diverter
100160 45	Inversor ABS cromo ABS chromed diverter
100161 45	Inversor botón Button diverter
100162 45	Inversor largo baño empotrado Built-in large push-button diverter
100162 41	Inversor largo baño empotrado Built-in large push-button diverter
100162 51	Inversor largo baño empotrado Built-in large push-button diverter
100162 52	Inversor largo baño empotrado Built-in large push-button diverter
100164 45	Inversor compacto Tau Tau compact diverter
100165 45	Inversor para termostático Klip Klip thermostatic diverter
100173 45	Inversor cerámico largo baño empotrado Built-in large push-button diverter
100174 45	Inversor convencional para batería bidet Bidet set conventional diverter
100180 41	Inversor compacto Kloe Kloe compact diverter
100180 45	Inversor compacto Kloe Kloe compact diverter
100180 51	Inversor compacto Kloe Kloe compact diverter
100180 52	Inversor compacto Kloe Kloe compact diverter
51745 45	Inversor columna redonda Round column diverter
51746 45	Inversor columna cuadrada Square column diverter
9908 0024	Inversor cerámico 2 vías 2 way ceramic diverter
9908 0025	Inversor cerámico 3 vías 3 way ceramic diverter
9908 0052	Inversor cerámico termostática 2 vías 2 way thermostatic tap ceramic diverter
9908 0054	Inversor cerámico termostática 3 vías 3 way thermostatic tap ceramic diverter
9908 0081	Inversor monomando bidé Single lever bidet diverter
9908 0204	Inversor set columna Column set diverter
9908 0221	Inversor columna monomando Single handle column diverter



Inversor
Diverter

Ref.:	Descripción Description
9908 0233	Inversor cerámico columna Oslo Oslo column ceramic diverter
9908 0237	Inversor columna Oslo Oslo column diverter
9908 0247	Inversor para 62119 31 45 66 Diverter for 62119 31 45 66
9908 0249	Inversor para 63119 26 45 66 Diverter for 63119 26 45 66
9908 0252	Inversor para 65212 18 45 66 Diverter for 65212 18 45 66
9908 0288	Inversor compacto Oslo Negro Black Oslo compact diverter
9908 0326	Inversor Negro Black Diverter
9908 0334	Inversor cerámico 2 vías 2 way ceramic diverter
9908 0335	Inversor cerámico 3 vías 3 way ceramic diverter
9908 0369	Inversor columna Oslo Negro Black Oslo column diverter
9908 0372	Inversor cerámico Ceramic diverter

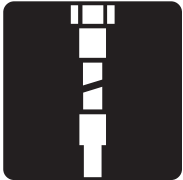

Conexiones
Connections

100012	Conexión DN6 10x1 - 15x1 a 15 cm 10x1 - 15x1 15 cm DN6 connection
100014	Juego de conexiones DN6 8x1 - H 3/8" a 50 cm 8x1 - F 3/8" 50 cm DN6 connection set
100100	Juego de conexiones 10 x 1 - H 3/8" a 55 cm 10 x 1 - F 3/8" 55 cm connection set
100101	Conexión PEX 10x1 - H 3/8" a 15 cm 10x1 - F 3/8" 15 cm PEX connection
100103	Juego de conexiones 10x1 x H 3/8" a 35 cm 10x1 - F 3/8" 35 cm connection set
100104	Conexión PVC 10x1 - H 3/8" a 60 cm 10x1 - F 3/8" 60 cm PVC connection
100105	Juego de conexiones 10x1 - H 3/8" a 40 cm 10x1 - F 3/8" 40 cm connection set
100111	Juego de conexiones 10x1 - H 1/2" a 40 cm 10x1 - F 1/2" 40 cm connection set
100113	Juego de conexiones DN6 10x1 - H 3/8" a 35 cm 10x1 - F 3/8" 35 cm DN6 connection set
100118	Juego de conexiones 10x1 - 15x1 a 15 cm 10x1 - 15x1 15 cm connection set
100129	Juego de conexiones 10x1 - H 3/8" a 60 cm 10x1 - F 3/8" 60 cm connection set
9908 0270	Conector 3/8" tubo 1/4" Fitting 3/8" pipe 1/4"



Conjunto sujeción
Fixation set

100090	Conjunto sujeción Fixation set
100091	Conjunto sujeción 2 tornillos 2 screws fixation set
100092	Conjunto sujeción Fixation set
100095	Conjunto sujeción Kenjo Kenjo fixation set
100097	Conjunto sujeción fregadera extraíble Pull-out sink tap fixation set
100098	Conjunto sujeción 1/2" 1/2" Fixation set
9908 0042	Conjunto sujeción M32 M32 fixation set
9908 0047	Conjunto sujeción lavabo Oslo Oslo basin fixation set
9908 0048	Conjunto sujeción lavabo medio alto Oslo Oslo medium high basin fixation set
9908 0049	Conjunto sujeción lavabo alto Oslo Oslo high basin fixation set
9908 0050	Conjunto sujeción bidé Oslo Oslo bidet fixation set
9908 0064	Conjunto Sujeción Fixation set
9908 0264	Conjunto sujeción 61200 61200 fixation set
9908 0265	Conjunto sujeción 120 M8 120 M8 fixation set
9908 0266	Conjunto sujeción FRK FRK fixation set
9908 0271	Conjunto Sujeción para 65700 18 45 66 Fixation set for 65700 18 45 66
9908 0453	Conjunto sujeción llave de paso Stopcock fixation set
9908 0468	Conjunto sujeción M28 M28 fixation set

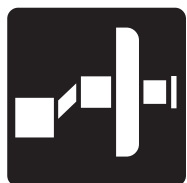

Conjunto excéntrica
Eccentric set

Ref.:	Descripción Description
100114 45	Conjunto florón y excéntricas oval Oval scutcheon and eccentric set
100125 43	Conjunto florón y excéntricas bronce Bronze scutcheon and eccentric set
100125 45	Conjunto florón y excéntricas Scutcheon and eccentric set
100126 41	Conjunto florón y excéntricas Redondo D60 Round D60 scutcheon and eccentric set
100126 45	Conjunto florón y excéntricas redondo D60 Round D60 scutcheon and eccentric set
100126 51	Conjunto florón y excéntricas Redondo D60 Round D60 scutcheon and eccentric set
100126 52	Conjunto florón y excéntricas Redondo D60 Round D60 scutcheon and eccentric set
100127 45	Conjunto florón y excéntricas redondo D65 Round D65 scutcheon and eccentric set
100128 45	Conjunto florón y excéntricas cuadrado Square scutcheon and eccentric set



Cuerpo
Body

51744 45	Cuerpo inversor set Oslo Oslo set diverter body
51744 41	Cuerpo inversor set Oslo Negro Black Oslo set diverter body
568113 45	Batería de baño con inversor Widespread bath mixer with diverter
568115 45	Grupo ducha empotrado 8" Built-in 8" shower mixer
568116 45	Grupo baño empotrado 8" con inversor Built-in 8" bath mixer with diverter
568120 45	Batería de lavabo Widespread wash-basin mixer
568131 45	Grupo de lavabo empotrado Built-in wash-basin mixer
568142 45	Batería de bidé con transmisión Widespread bidet mixer with transmission
568170 45	Llave de paso 1/2" Stopcock 1/2"
5CM63110 45	Cuerpo monomando columna cuadrada Square single handle column body
5CM64111 45	Cuerpo monomando columna Koral Koral column single handle body
5CM65110 45	Cuerpo monomando columna redonda Round column single handle body
5CM65111 45	Cuerpo monomando columna Oslo Oslo column single lever mixer body
5CM65111 41	Cuerpo monomando columna Oslo Oslo column single lever mixer body
5CT63110 45	Cuerpo termostático columna Kenjo Kenjo column thermostatic mixer body
5CT65110 45	Cuerpo termostático columna Tau Tau column thermostatic mixer body
5CT65111 45	Cuerpo termostático columna Oslo Oslo column thermostatic mixer body
5CT67111 41	Cuerpo termostático columna Oslo Oslo column thermostatic mixer body
9908 0202	Racord columna Kenjo Kenjo column conector
9908 0345	Racord para CT67110 26 CT67110 26 column conector
9908 0458	Racord mezclador sanitario Sanitary mixer conector
9908 0462	Racord mezclador sanitario Negro Black sanitary mixer conector
9908 0473	Racord mezclador sanitario Sanitary mixer conector
9908 0474	Racord mezclador sanitario Sanitary mixer conector
65116 19 45 66	Monomando empotrado con inversor 2 vías 2 way Built-in single lever mixer with diverter
5CM64111 41	Cuerpo monomando columna Koral Negro Black Koral column single handle body



Placa
Tap plate

Ref.:	Descripción Description
9908 0053	Placa termostática empotrada 2 vías Built-in 2 way thermostatic mixer plate
9908 0228	Placa lavabo ovalada D35 Negra Black D35 oval basin mixer plate
9908 0323	Placa de lavabo empotrado Negro Black Built-in basin mixer plate
9908 0327	Placa ducha empotrada Negro Black Built-in shower mixer plate
9908 0328	Placa baño/ducha empotrado Negro Black Built-in bath/shower mixer plate
9908 0329	Placa de empotrada 2 vías Negra Black Built-in 2 way plate
9908 0330	Placa de empotrada 3 vías Negra Black Built-in 3 way plate
9908 0331	Placa inversor cerámico Negra Black Built-in ceramic diverter plate
9908 0341	Placa ducha empotrada Negra Black Built-in shower mixer plate
9908 0342	Placa baño/ducha empotrado Negro Black Built-in bath/shower mixer plate
9908 0444	Placa llave de paso Negra Black Stopcock plate
9908 0456	Placa mezclador sanitario Sanitary mixer plate
9908 0460	Placa mezclador sanitario Negro Black sanitary mixer plate
9908 0471	Placa mezclador sanitario Sanitary mixer plate
9908 0472	Placa mezclador sanitario Sanitary mixer plate
9908 0483	Placa llave de paso Stopcock plate
9908 0484	Placa llave de paso Stopcock plate
PB115 40 45	Placa redonda para empotrada Built-in round plate
PB117 40 45	Placa redonda empotrada 2 vías Built-in 2 way round plate
PB118 40 45	Placa redonda empotrada 3 vías Built-in 3 way round plate
PC0115 35 41	Placa ducha empotrada Built-in 1 way plate
PC0115 35 45	Placa ducha empotrada Built-in 1 way plate
PC0115 35 51	Placa ducha empotrada Built-in 1 way plate
PC0115 35 52	Placa ducha empotrada Built-in 1 way plate
PC0116 35 41	Placa empotrada 2 vías Built-in shower mixer plate
PC0116 35 45	Placa empotrada 2 vías Built-in shower mixer plate
PC0116 35 51	Placa empotrada 2 vías Built-in shower mixer plate
PC0116 35 52	Placa empotrada 2 vías Built-in shower mixer plate
PC0131 35 41	Placa lavabo empotrado Built-in basin mixer plate
PC0131 35 45	Placa lavabo empotrado Built-in basin mixer plate
PC0131 35 51	Placa lavabo empotrado Built-in basin mixer plate
PC0131 35 52	Placa lavabo empotrado Built-in basin mixer plate
PC114	Placa inversor cerámico Built-in ceramic diverter plate
PC115	Placa ducha empotrada Built-in shower mixer plate
PC116	Placa baño/ducha empotrado Built-in bath/shower mixer plate
PC117	Placa empotrada 2 vías Built-in 2 way plate
PC118	Placa empotrada 3 vías Built-in 3 way plate
PC131	Placa lavabo empotrado Built-in basin mixer plate
PK115	Placa ducha empotrada Built-in shower mixer plate
PK116	Placa baño/ducha empotrado Built-in bath/shower mixer plate
PK131	Placa lavabo caño cuadrado Square spout basin plate



Placa
Tap plate

Ref.:	Descripción Description
PL115	Placa ducha empotrada Built-in shower mixer plate
PL116	Placa baño/ducha empotrado Built-in bath/shower mixer plate
PL131	Placa lavabo ovalada D35 D35 oval basin mixer plate
PO113	Placa inversor ovalada Diverter oval plate
PO115	Placa ovalada ducha empotrada Built-in shower mixer plate
PO117	Placa ovalada empotrada 2 vías Built-in 2 way oval plate
PO118	Placa ovalada empotrada 3 vías Built-in 3 way oval plate
PO131	Placa lavabo ovalada Oval basin plate
PR113	Placa inversor redonda Diverter round plate
PS115	Placa ducha empotrada Built-in shower mixer plate
PS116	Placa baño/ducha empotrado Built-in bath/shower mixer plate
PT113	Placa inversor cuadrada Diverter square plate
PT115	Placa ducha empotrada Built-in shower tap plate
PT116	Placa baño/ducha empotrado Built-in bath/shower mixer plate
PT117	Placa rectangular empotrada 2 vías Built-in 2 way rectangular plate
PT118	Placa rectangular inversor empotrada 3 vías Built-in 3 way rectangular plate
PT131	Placa lavabo rectangular Rectangular basin mixer plate



Set juntas
Gasket sets

9908 0063	Set juntas montura convencional Join set conventional headwork
9908 0074	Set de juntas para 61900 28 45 66 Gasket set for 61900 28 45 66
9908 0075	Set de juntas para 65900 18 45 66 Gasket set for 65900 18 45 66
9908 0152	Set de juntas serie A A series gasket set
9908 0153	Set de juntas serie B B series gasket set
9908 0154	Set de juntas serie C C series gasket set
9908 0200	Set juntas columna redonda Round column gasket set
9908 0209	Set de juntas Gasket set
9908 0210	Set juntas columna cuadrada Square column gasket set
9908 0230	Set juntas columna Oslo Oslo column gasket set
9908 0257	Set de juntas para 65212 18 45 66 Gasket set for 65212 18 45 66
9908 0261	Set de juntas para 65219 18 45 66 Gasket set for 65219 18 45 66
9908 0263	Set de juntas para 65700 18 45 66 Gasket set for 65700 18 45 66
9908 0269	Set de juntas para 65215 40 60 66 Gasket set for 65215 40 60 66
J100206	Junta tapón V-click 1 1/2" 1 1/2" V-click cap gasket
J15	Set de juntas inversor monomando bidé Single lever bidet mixer diverter gasket set
J16	Set de juntas R16 R16 gasket set
J17	Set de juntas columna extensible Extensible column gasket set
J18	Set de juntas para 65203 18 60 66 Gasket set for 65203 18 60 66
J19	Set de juntas para 65208 18 60 66 Gasket set for 65208 18 60 66
J20	Set de juntas para 65211 18 60 66 Gasket set for 65211 18 60 67
J61	Set de juntas 61200 61200 gasket set
J65	Set de juntas R21 R21 gasket set
J67	Set de juntas 65702 18 45 66 65702 18 45 66 gasket set



Set juntas

Gasket sets

Ref.:	Descripción Description
J68	Set de juntas caño tubo Pipe spout gasket set
9908 0371	Set de juntas para 65200 19 45 66 Gasket set for 65200 19 45 66
9908 0394	Set de juntas para FRV61208 Gasket set for FRV61208
9908 0487	Set de juntas Gasket set



Muelles

Springs

9908 0155	Muelle click L25 L25 click spring
9908 0156	Muelle click L35 L35 click spring
9908 0157	Muelle click L38 L38 click spring



Set retenciones

Check valve sets

9908 0011	Retenciones termostáticas murales Wall thermostatic mixer check valve
9908 0012	Retenciones termostáticas empotradas Built-in tap thermostatic mixer check valve
9908 0236	Set de retenciones para termostáticas Oslo Oslo thermostatic mixer check valve set



Tapones

Caps

9908 0162	Tapón V-Click "Luxe" Cap V-Click "Luxe"
9908 0163	Tapon V-Click Luxe Bronce Cap V-Click Luxe Bronze
9908 0164	Tapón V-Click Kenjo Kenjo V-click cap
9908 0165	Tapón V-click 1 1/4" 1 1/4" V-click cap
9908 0166	Tapón V-click 1 1/2" 1 1/2" V-click cap
9908 0347	Tapón V-click 1 1/2" Bronce Bronze 1 1/2" Cap V-click
9908 0348	Tapon V-Click "Luxe Negro" Cap V-Click "Luxe Black"
9908 0167	Tapón V-click 1 1/4" 1 1/4" V-click cap
9908 0168	Tapón V-click 1 1/4" 1 1/4" V-click cap
9908 0350	Tapon V-Click "Luxe Brushed PVD Gold" Cap V-Click "Luxe Brushed PVD Gold"
9908 0380	Tapon V-Click Cap V-Click
9908 0347	Tapón V-click 1 1/2" Bronce Bronze 1 1/2" Cap V-click

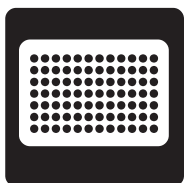

Filtros

Filter

FT91	Filtro ultrafiltración Ultrafiltration filter
FT92	Filtro de clorador Dechlorinator filter

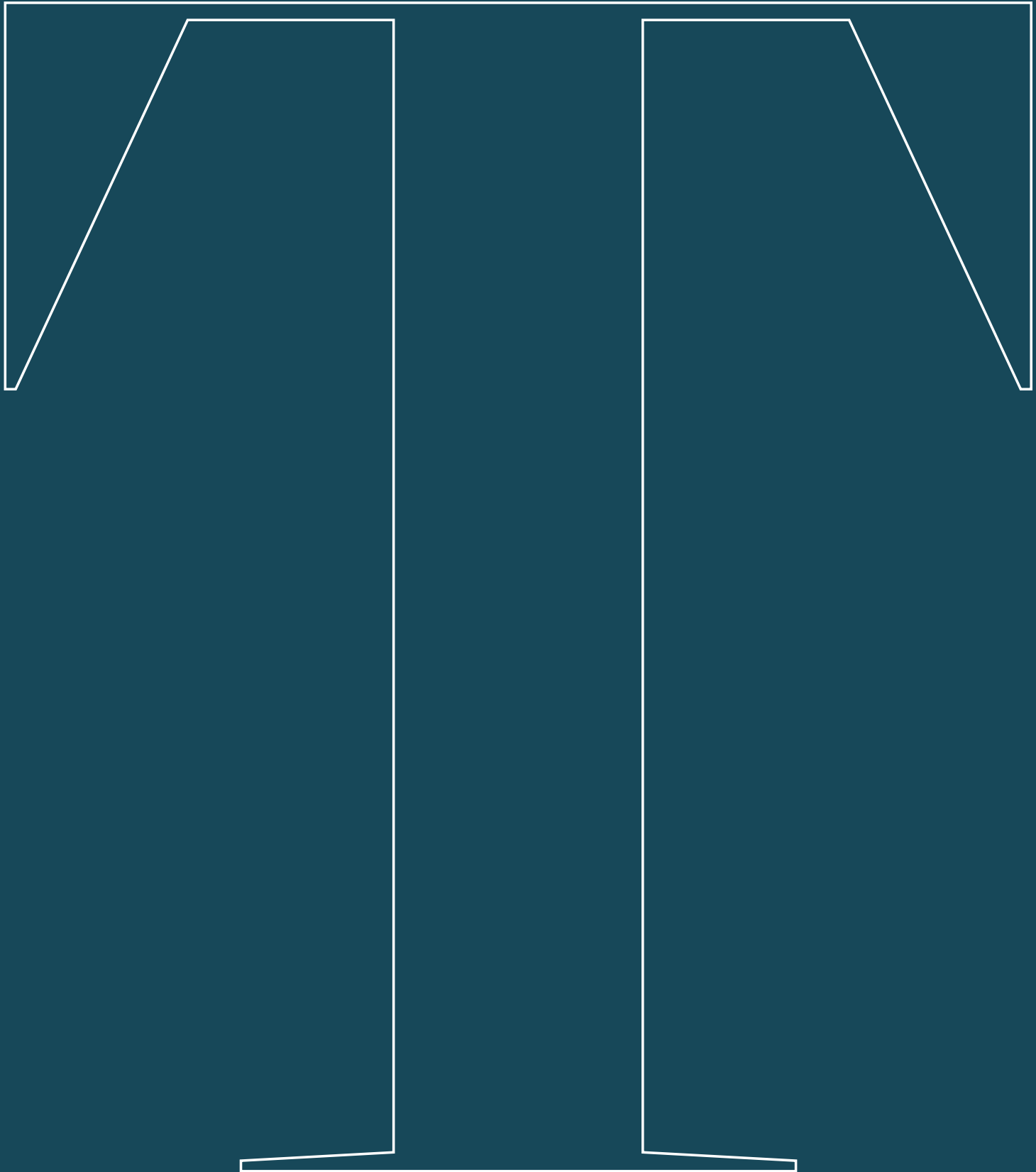

Información técnica

Technical information

Consulta la ficha técnica de nuestros productos.

Busque la referencia del artículo y encontrará toda la información técnica necesaria referente al producto.

Consult data sheet of our product.

Locate the reference article and find all the technical information regarding the product.

Símbolos / Symbols



Maneta
Handle



Volantes
Handles



Florón
Scutcheon



Duchas
Shower



Flexo
Flexible hose



Soporte ducha fijos
Fixed shower holders



Soportes ducha deslizantes
Sliding shower holders



Soporte
Holder



Caño
Spout



Atomizador (Aireador)
Aerator



Atomizador
Aerator



Cartucho
Cartridge



Montura
Headwork



Inversor
Diverter



Conexiones
Connections



Conexión flexible
Connection set



Conjunto sujección
Fixation set



Conjunto excéntrica
Eccentric set



Cuerpo
Body



Placa
Tap plate



Set juntas
Gasket sets



Muelles
Springs

Serie Kloe

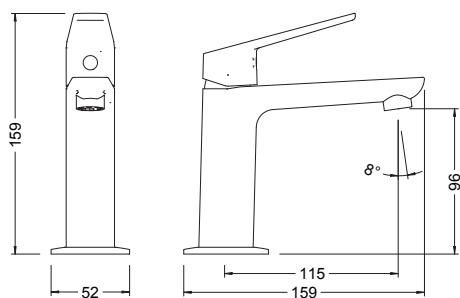

Ref.: 69130 34 45 66

Box: 1 | Carton: 12 | Pallet: 192



100001 34 45 | 100025 45 | 9908 0467 | 100014



9908 0468

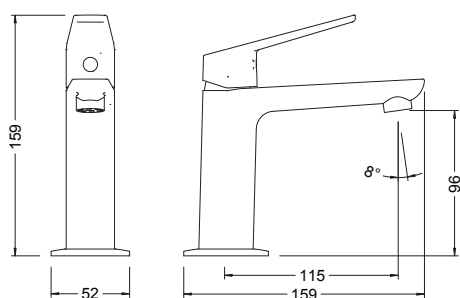

Ref.: 69130 34 41 66

Box: 1 | Carton: 12 | Pallet: 192



100001 34 41 | 100025 41 | 9908 0467 | 100014



9908 0468

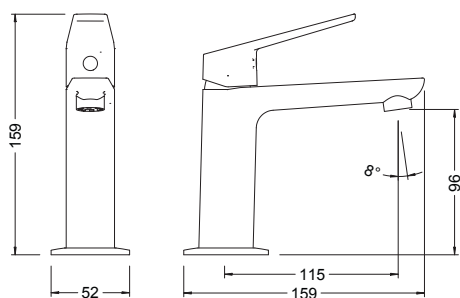

Ref.: 69130 34 51 66

Box: 1 | Carton: 12 | Pallet: 192



100001 34 51 | 100025 51 | 9908 0467 | 100014



9908 0468

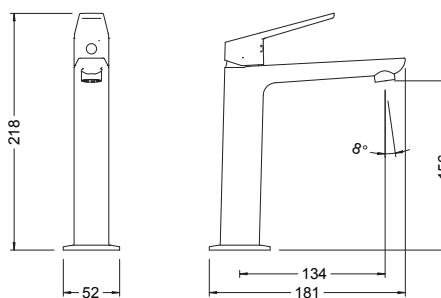

Ref.: 69134 34 45 66

Box: 1 | Carton: 6 | Pallet: 96



100001 34 45 | 100025 45 | 9908 0467 | 100014



9908 0468

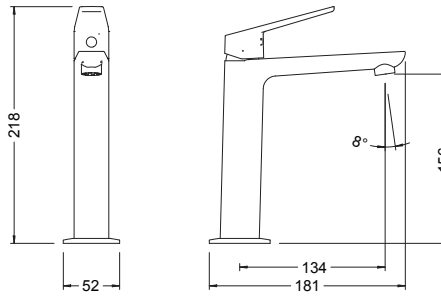

Ref.: 69134 34 41 66

Box: 1 | Carton: 6 | Pallet: 96



100001 34 41 | 100025 41 | 9908 0467 | 100014



9908 0468

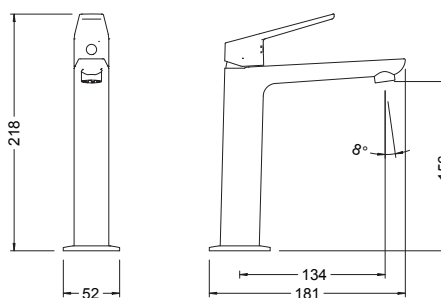

Ref.: 69134 34 51 66

Box: 1 | Carton: 6 | Pallet: 96



100001 34 51 | 100025 51 | 9908 0467 | 100014



9908 0468

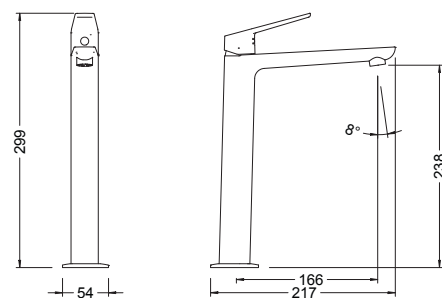

Ref.: 69136 34 45 66

Box: 1 | Carton: 10 | Pallet: 80



100001 34 45 | 100025 45 | 9908 0467 | 100014



9908 0468

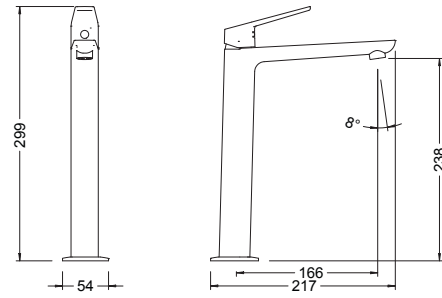

Ref.: 69136 34 41 66

Box: 1 | Carton: 10 | Pallet: 80



100001 34 41 | 100025 41 | 9908 0467 | 100014



9908 0468

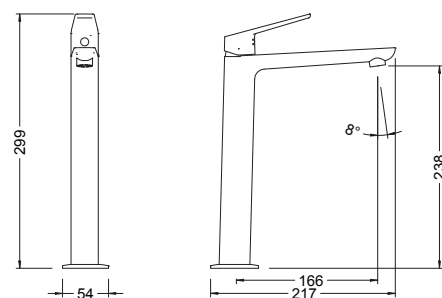

Ref.: 69136 34 51 66

Box: 1 | Carton: 10 | Pallet: 80



100001 34 51 | 100025 51 | 9908 0467 | 100014



9908 0468

Serie Kloe

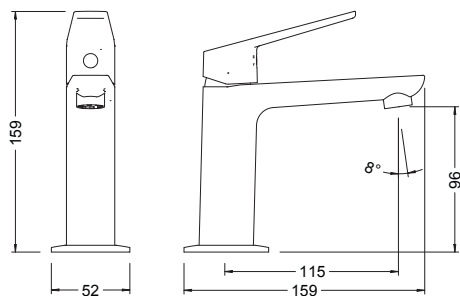

Ref.: 69130 34 52 66

Box: 1 | Carton: 12 | Pallet: 192

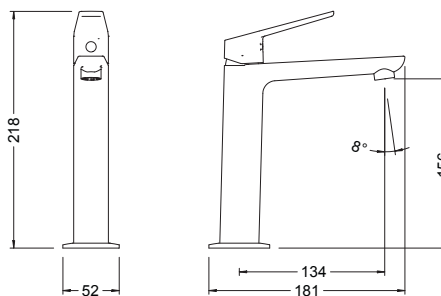

Ref.: 69134 34 52 66

Box: 1 | Carton: 6 | Pallet: 96

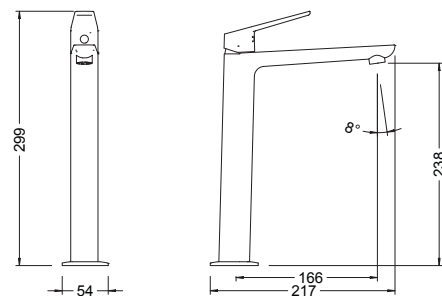

Ref.: 69136 34 52 66

Box: 1 | Carton: 10 | Pallet: 80

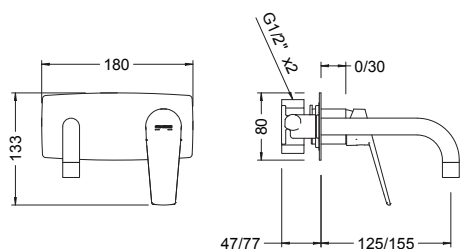

Ref.: 69131 34 45 66

Box: 1 | Carton: 6 | Pallet: 96

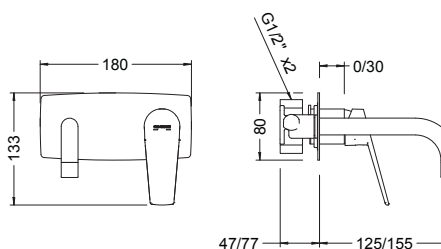

Ref.: 69131 34 41 66

Box: 1 | Carton: 6 | Pallet: 96

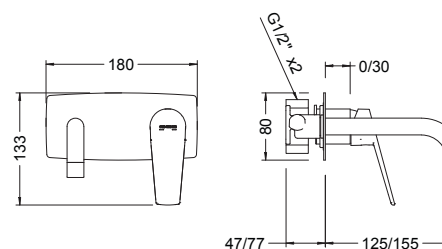

Ref.: 69131 34 51 66

Box: 1 | Carton: 6 | Pallet: 96

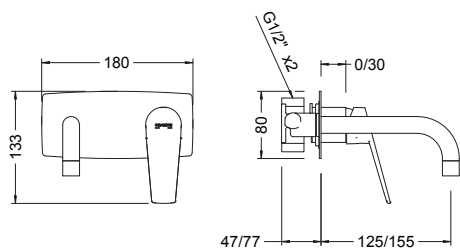

Ref.: 69131 34 52 66

Box: 1 | Carton: 6 | Pallet: 96

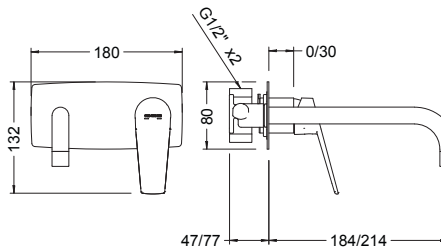

Ref.: 69132 34 45 66

Box: 1 | Carton: 6 | Pallet: 96

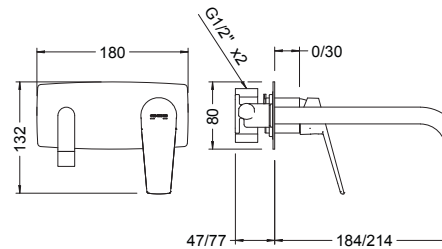

Ref.: 69132 34 41 66

Box: 1 | Carton: 6 | Pallet: 96



Serie Kloe

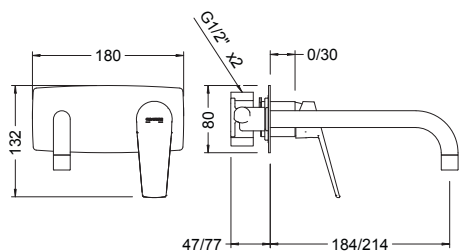

Ref.: 69132 34 51 66

Box: 1 | Carton: 6 | Pallet: 96



PC0131 35 51

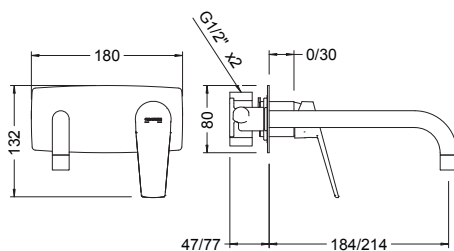

Ref.: 69132 34 52 66

Box: 1 | Carton: 6 | Pallet: 96



PC0131 35 52

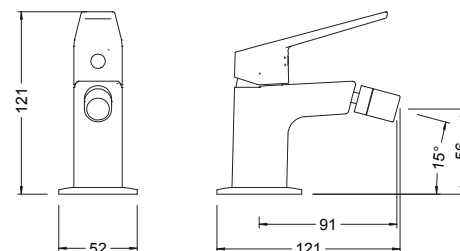

Ref.: 69140 34 45 66

Box: 1 | Carton: 12 | Pallet: 192



9908 0468

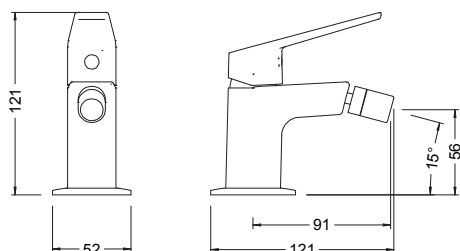

Ref.: 69140 34 41 66

Box: 1 | Carton: 12 | Pallet: 192



9908 0468

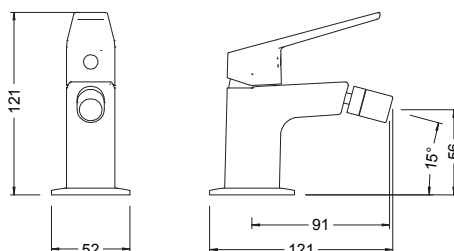

Ref.: 69140 34 51 66

Box: 1 | Carton: 12 | Pallet: 192



9908 0468

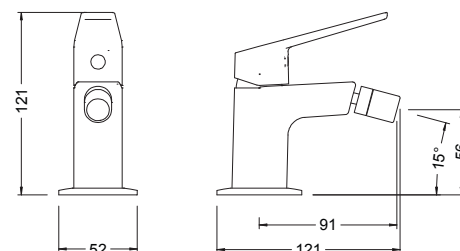

Ref.: 69140 34 52 66

Box: 1 | Carton: 12 | Pallet: 192



9908 0468

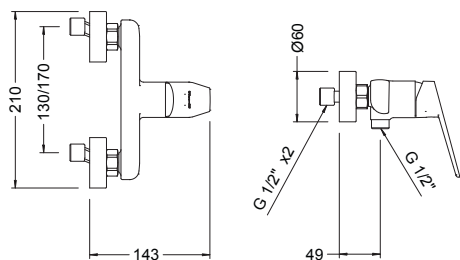

Ref.: 69110 34 45 66

Box: 1 | Carton: 8 | Pallet: 64



100053 | 100126 45

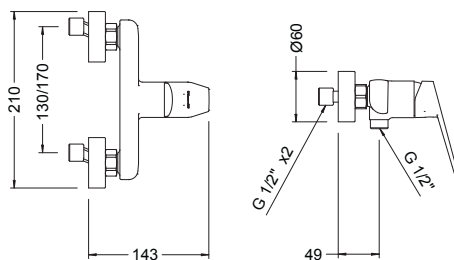

Ref.: 69110 34 41 66

Box: 1 | Carton: 8 | Pallet: 64



100153 41 | 100053

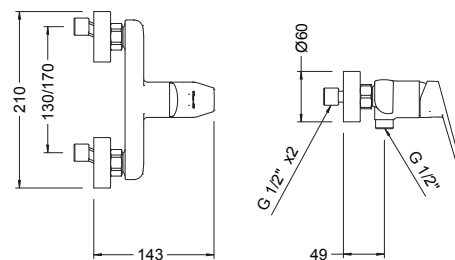

Ref.: 69110 34 51 66

Box: 1 | Carton: 8 | Pallet: 64



100153 51 | 100053

Serie Kloe

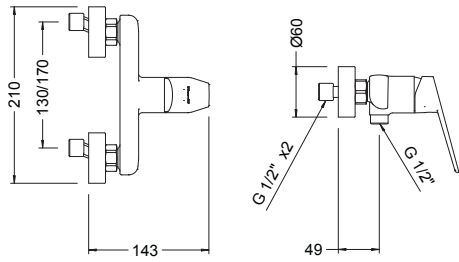

Ref.: 69110 34 52 66

Box: 1 | Carton: 8 | Pallet: 64

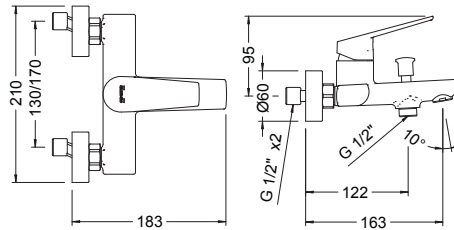

Ref.: 69100 34 45 66

Box: 1 | Carton: 8 | Pallet: 64

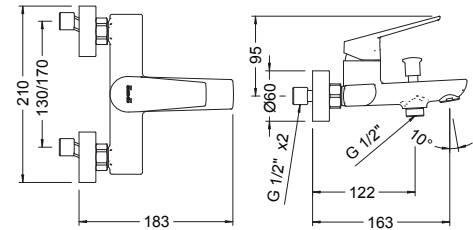

Ref.: 69100 34 41 66

Box: 1 | Carton: 8 | Pallet: 64

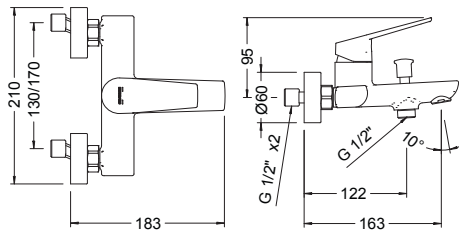

Ref.: 69100 34 52 66

Box: 1 | Carton: 8 | Pallet: 64

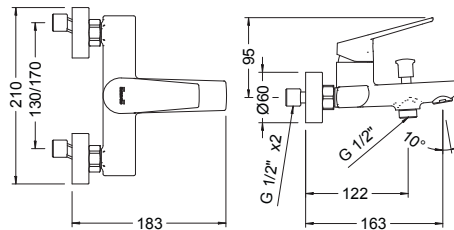

Ref.: 69100 34 52 66

Box: 1 | Carton: 8 | Pallet: 64

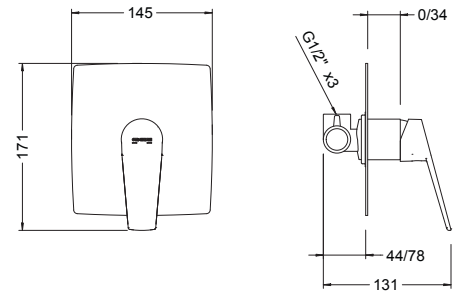

Ref.: 69115 34 45 66

Box: 1 | Carton: 12 | Pallet: 192

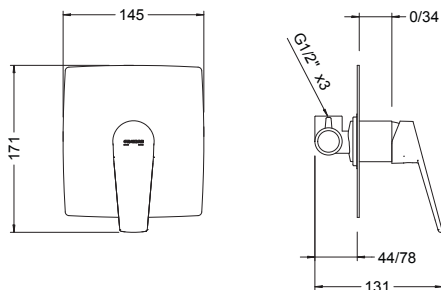

Ref.: 69115 34 41 66

Box: 1 | Carton: 12 | Pallet: 192

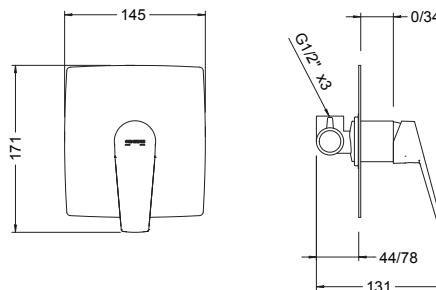

Ref.: 69115 34 52 66

Box: 1 | Carton: 12 | Pallet: 192

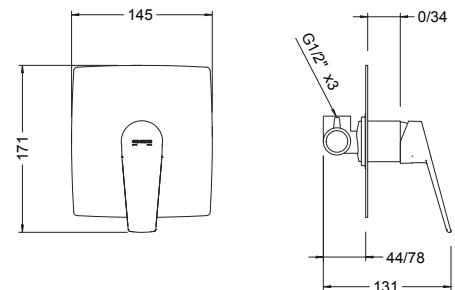

Ref.: 69115 34 51 66

Box: 1 | Carton: 12 | Pallet: 192



Serie Kloe

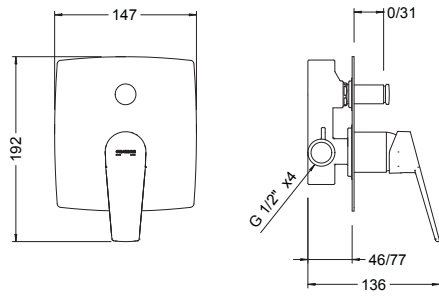

Ref.: 69116 34 45 66

Box: 1 | Carton: 6 | Pallet: 96

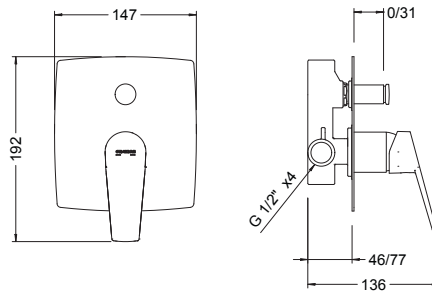

Ref.: 69116 34 41 66

Box: 1 | Carton: 6 | Pallet: 96

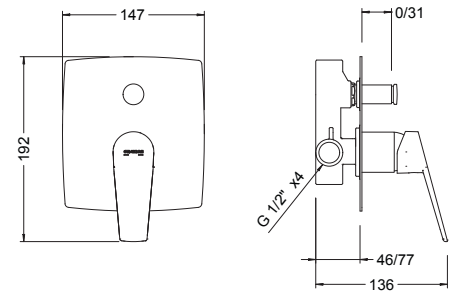

Ref.: 69116 34 51 66

Box: 1 | Carton: 6 | Pallet: 96

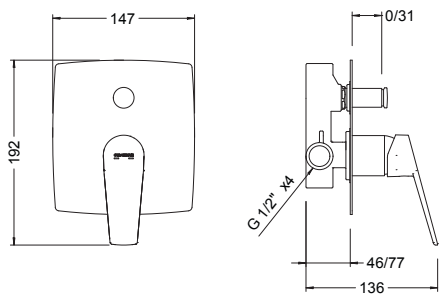

Ref.: 69116 34 52 66

Box: 1 | Carton: 6 | Pallet: 96



Serie Koral

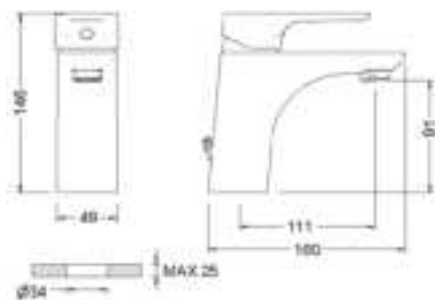

Ref.: 64150 32 45 66

Box: 1 | Carton: 12 | Pallet: 288

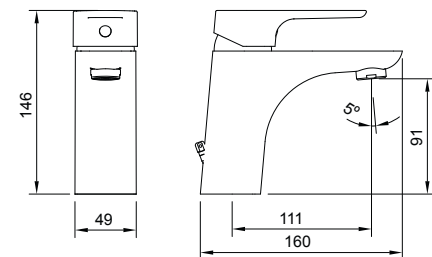

Ref.: 64130 32 45 66

Box: 1 | Carton: 12 | Pallet: 288

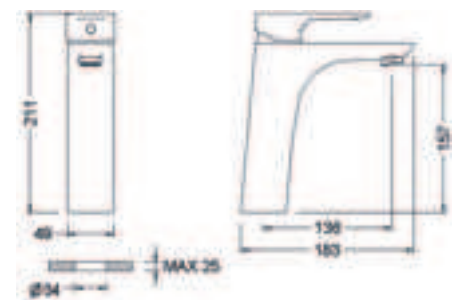

Ref.: 64134 32 45 66

Box: 1 | Carton: 10 | Pallet: 180



Serie Koral

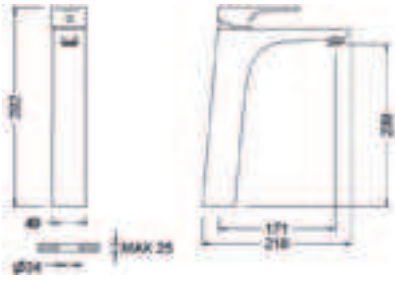

Ref.: 64136 32 45 66

Box: 1 | Carton: 6 | Pallet: 108

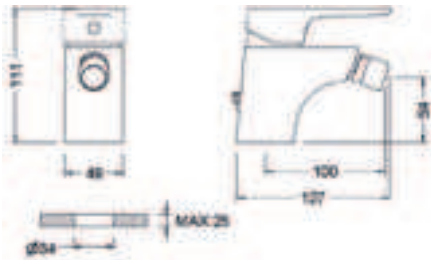

Ref.: 64140 32 45 66

Box: 1 | Carton: 8 | Pallet: 480

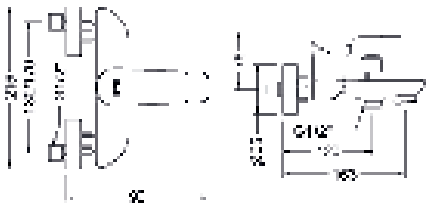

Ref.: 64100 32 45 66

Box: 1 | Carton: 8 | Pallet: 96



Ref.: 64131 32 45 66

Box: 1 | Carton: 6 | Pallet: 144



PC131



Ref.: 64142 32 45 66

Box: 1 | Carton: 12 | Pallet: 288



J15



Ref.: 64119 32 45 66

Box: 1 | Carton: 2 | Pallet: 8

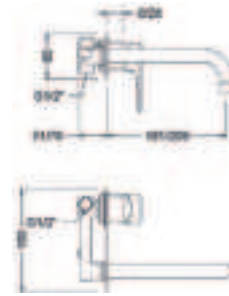

Ref.: 64132 32 45 66

Box: 1 | Carton: 6 | Pallet: 144



Ref.: 64110 32 45 66

Box: 1 | Carton: 8 | Pallet: 96

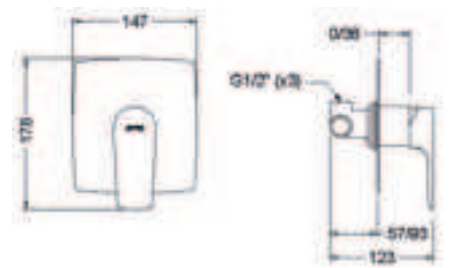

Ref.: 64115 32 45 66

Box: 1 | Carton: 12 | Pallet: 216



Serie Koral

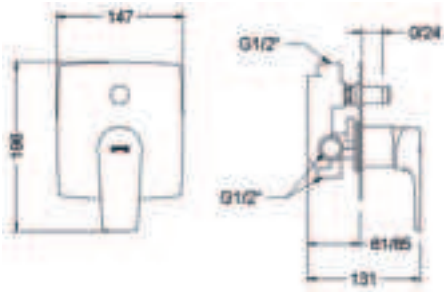

Ref.: 64116 32 45 66

Box: 1 | Carton: 12 | Pallet: 216

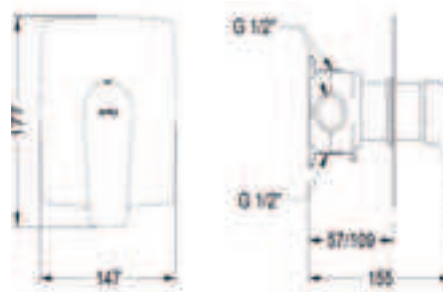

Ref.: 64316 32 45 66

Box: 1 | Carton: 12 | Pallet: 144

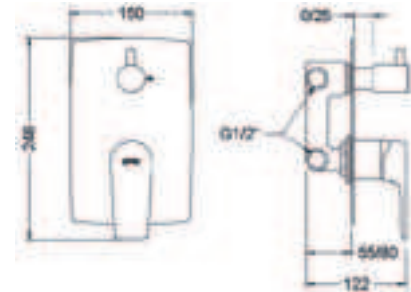

Ref.: 64117 32 45 66

Box: 1 | Carton: 6 | Pallet: 108

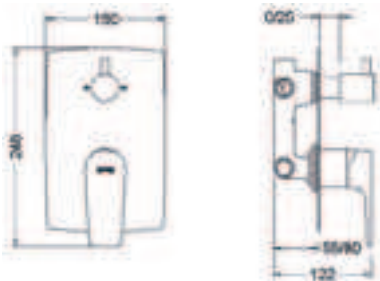
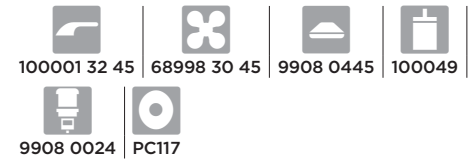

Ref.: 64118 32 45 66

Box: 1 | Carton: 6 | Pallet: 108

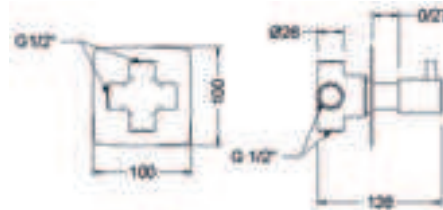
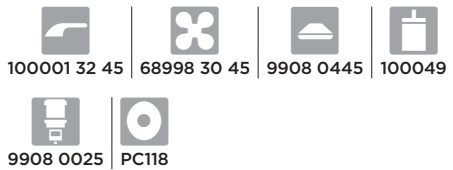

Ref.: 64114 30 45 66

Box: 1 | Carton: 8 | Pallet: 288

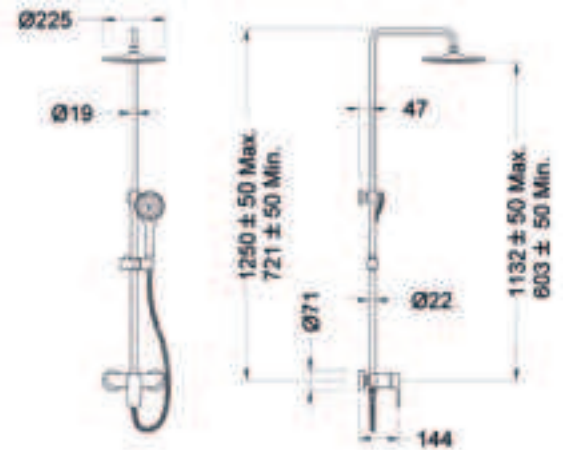

Ref.: CM64110 32

Box: 1 | Carton: 2 | Pallet: 18

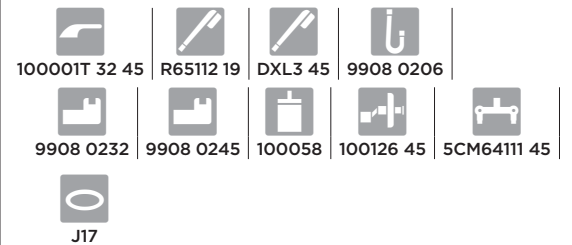

Serie Koral Black

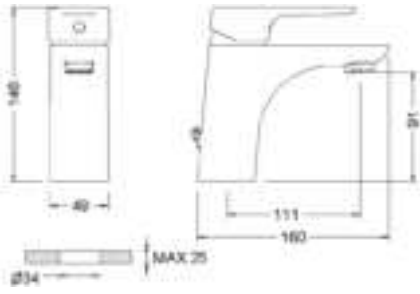

Ref.: 64130 32 41 66

Box: 1 | Carton: 12 | Pallet: 288

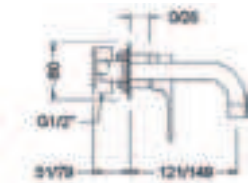

Ref.: 64131 32 41 66

Box: 1 | Carton: 7 | Pallet: 112



9908 0323



Ref.: 64142 32 41 66

Box: 1 | Carton: 10 | Pallet: 240



J15

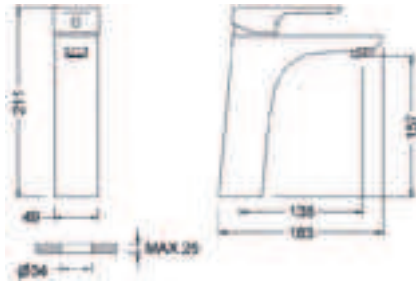

Ref.: 64134 32 41 66

Box: 1 | Carton: 9 | Pallet: 144



Ref.: 64132 32 41 66

Box: 1 | Carton: 7 | Pallet: 112



Ref.: 64110 32 41 66

Box: 1 | Carton: 8 | Pallet: 96



9908 0485 | 100049

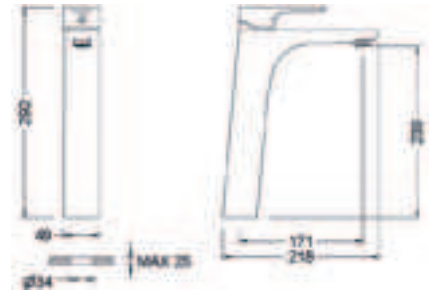

Ref.: 64136 32 41 66

Box: 1 | Carton: 9 | Pallet: 144

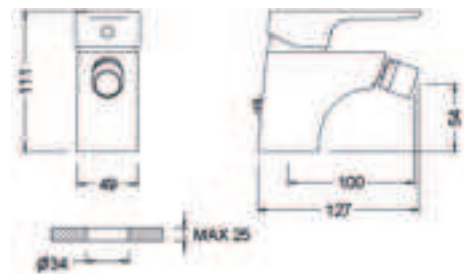

Ref.: 64140 32 41 66

Box: 1 | Carton: 17 | Pallet: 340

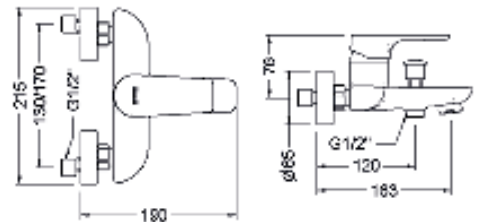

Ref.: 64100 32 41 66

Box: 1 | Carton: 8 | Pallet: 96



9908 0485 | 100083 41 | 100049 | 100160 41

Serie Koral Black

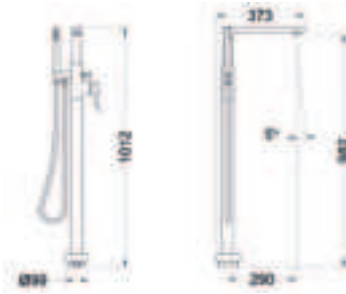

Ref.: 64119 32 41 66

Box: 1 | Carton: 2 | Pallet: 8

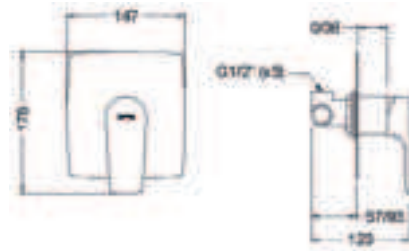
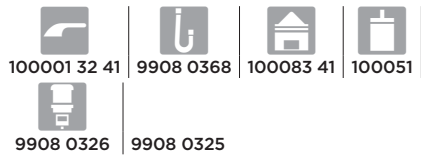

Ref.: 64115 32 41 66

Box: 1 | Carton: 12 | Pallet: 192

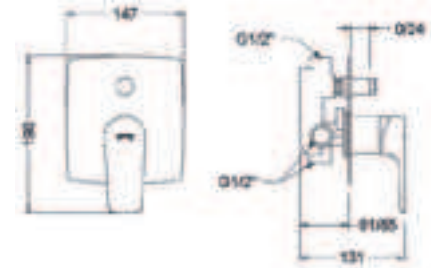

Ref.: 64116 32 41 66

Box: 1 | Carton: 12 | Pallet: 192

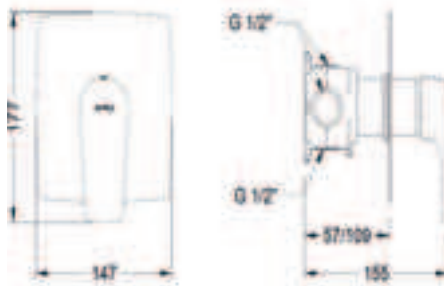

Ref.: 64316 32 41 66

Box: 1 | Carton: 12 | Pallet: 144

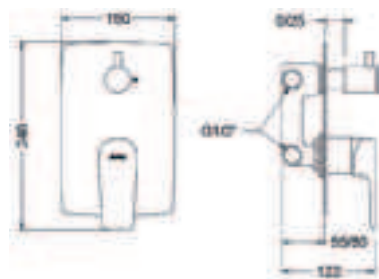

Ref.: 64117 32 41 66

Box: 1 | Carton: 9 | Pallet: 108

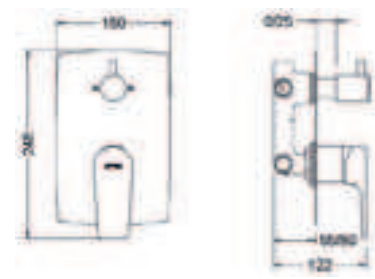
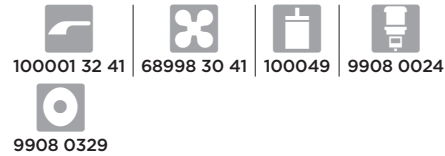

Ref.: 64118 32 41 66

Box: 1 | Carton: 9 | Pallet: 108

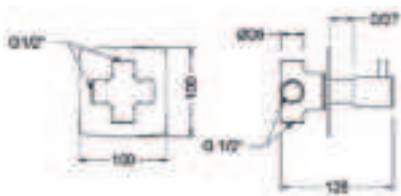
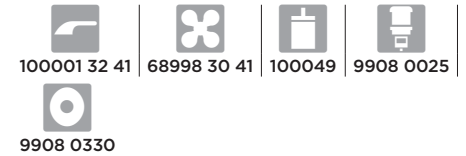

Ref.: 64114 30 41 66

Box: 1 | Carton: 22 | Pallet: 264

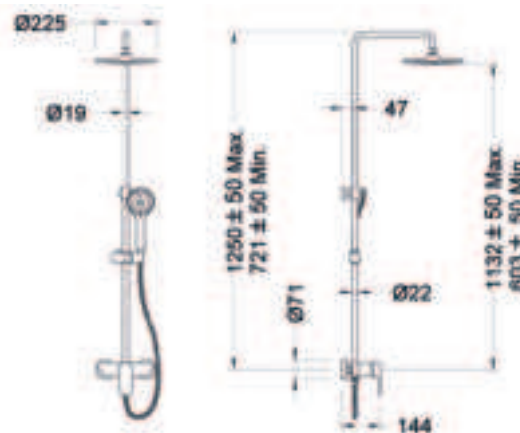

Ref.: CM64111 32 41

Box: 1 | Carton: 2 | Pallet: 18



Serie Kode Acabado cromado. Cartucho 40. Chromed finish. Cartridge 40

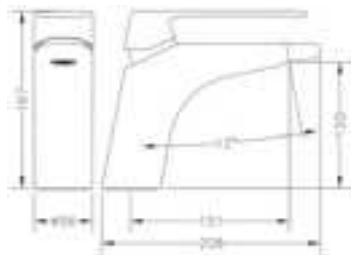

Ref.: 62130 08 45 66

Box: 1 | Carton: 8 | Pallet: 192

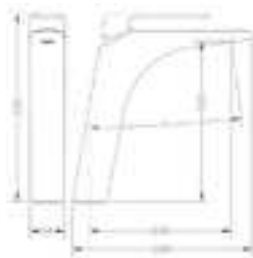

Ref.: 62136 08 45 66

Box: 1 | Carton: 4 | Pallet: 96

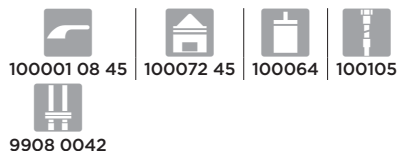

Ref.: 62131 31 45 66

Box: 1 | Carton: 6 | Pallet: 144

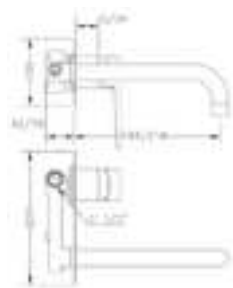

Ref.: 62132 31 45 66

Box: 1 | Carton: 6 | Pallet: 144

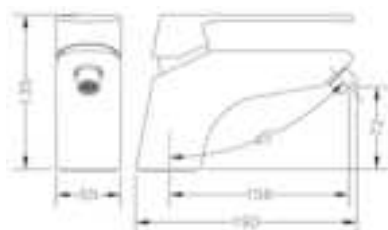

Ref.: 62140 08 45 66

Box: 1 | Carton: 8 | Pallet: 192

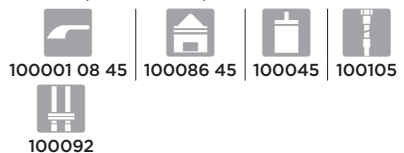

Ref.: 62142 31 45 66

Box: 1 | Carton: 12 | Pallet: 216



Ref.: 62100 08 45 67

Box: 1 | Carton: 6 | Pallet: 144

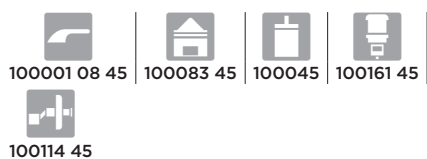

Ref.: 62110 31 45 67

Box: 1 | Carton: 6 | Pallet: 144



Ref.: 62119 31 45 66

Box: 1 | Carton: 2 | Pallet: 12



Serie Kode Acabado cromado. Cartucho 40. Chromed finish. Cartridge 40

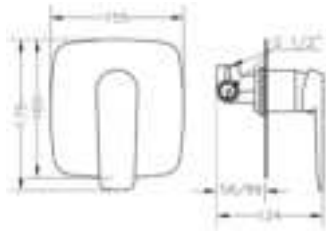

Ref.: 62115 31 45 66

Box: 1 | Carton: 8 | Pallet: 192



100001 31 45 | 100049 | PO115

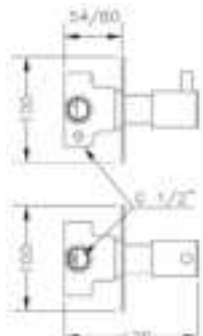

Ref.: 62114 30 45 66

Box: 1 | Carton: 8 | Pallet: 384



68998 30 45 | 9908 0025 | PO113

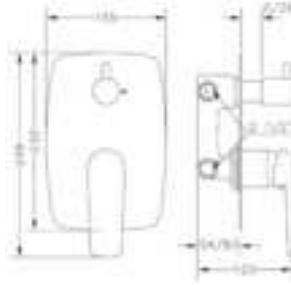

Ref.: 62117 31 45 66

Box: 1 | Carton: 6 | Pallet: 108

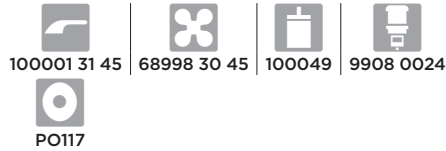

100001 31 45 | 68998 30 45 | 100049 | 9908 0024

PO117



Ref.: 62118 31 45 66

Box: 1 | Carton: 6 | Pallet: 108

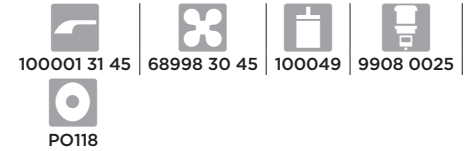

100001 31 45 | 68998 30 45 | 100049 | 9908 0025

PO118

Serie Oslo Acabado cromado. Cartucho 35. Chromed finish. Cartridge 35



Ref.: 65150 19 45 66

Box: 1 | Carton: 12 | Pallet: 192



100001F 19 45 | 9908 0434 | 100105 | 9908 0047

9908 0332



Ref.: 65130 19 45 66

Box: 1 | Carton: 12 | Pallet: 192



100001 19 45 | 100066 45 | 100036 | 100105



9908 0047



Ref.: 65134 19 45 66

Box: 1 | Carton: 10 | Pallet: 80



100001 19 45 | 100066 45 | 100036 | 100100 | 9908 0048

Serie Oslo Acabado cromado. Cartucho 35. Chromed finish. Cartridge 35



Ref.: 65136 19 45 66

Box: 1 | Carton: 10 | Pallet: 80

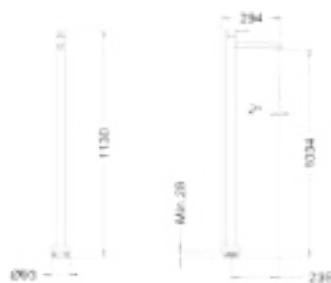
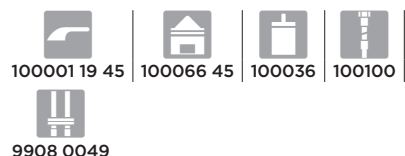

Ref.: 65139 19 45 66

Box: 1 | Carton: 2 | Pallet: 12



Ref.: 65131 19 45 66

Box: 1 | Carton: 6 | Pallet: 144

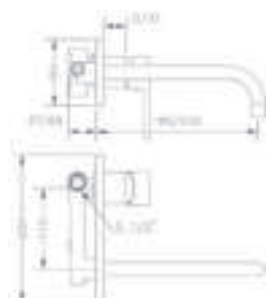

Ref.: 65132 19 45 66

Box: 1 | Carton: 6 | Pallet: 144



Ref.: 65140 19 45 66

Box: 1 | Carton: 12 | Pallet: 192

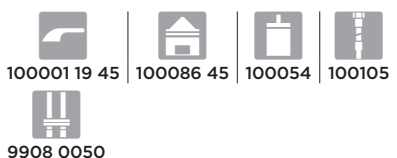

Ref.: 65142 19 45 66

Box: 1 | Carton: 12 | Pallet: 288



Ref.: 65144 19 45 66

Box: 1 | Carton: 18 | Pallet: 288



Ref.: 65144 19 45 67

Box: 1 | Carton: 20 | Pallet: 640

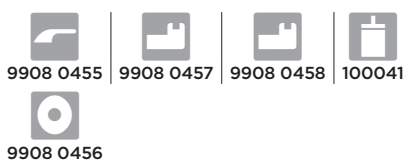

Ref.: 65100 19 45 66

Box: 1 | Carton: 8 | Pallet: 96

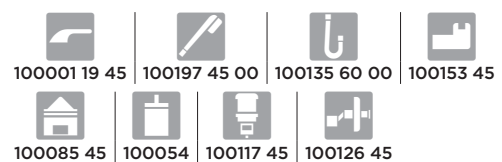

Serie Oslo Acabado cromado. Cartucho 35. Chromed finish. Cartridge 35



Ref.: 65110 19 45 66

Box: 1 | Carton: 8 | Pallet: 96

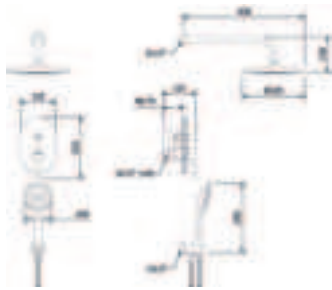
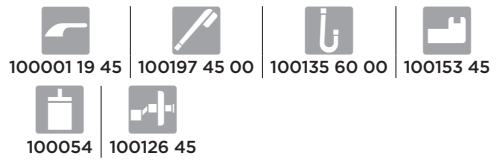

Ref.: ST116 19

Box: 1 | Carton: 2 | Pallet: 54

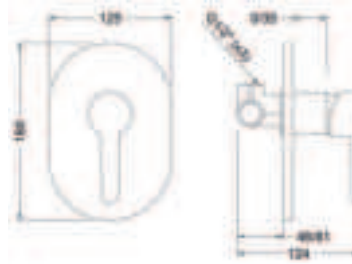

Ref.: 65115 19 45 66

Box: 1 | Carton: 12 | Pallet: 324

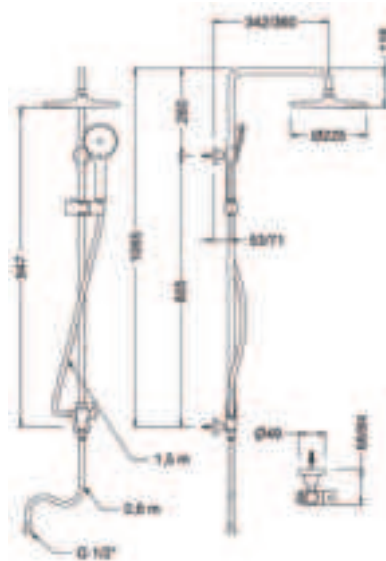

Ref.: 1744 45

Box: 1 | Carton: 4 | Pallet: 24

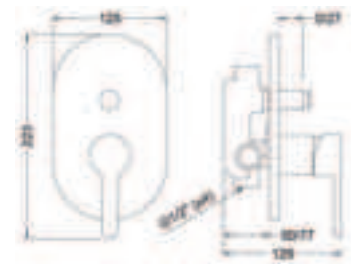
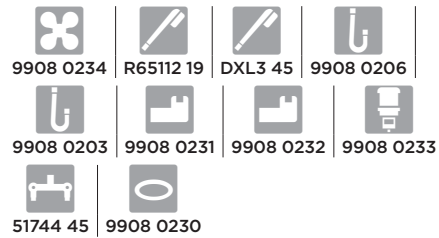

Ref.: 65116 19 45 66

Box: 1 | Carton: 12 | Pallet: 216

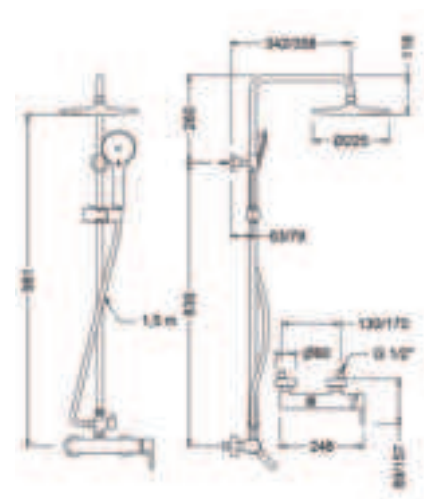

Ref.: CM65110 19

Box: 1 | Carton: 4 | Pallet: 24



Serie Oslo Acabado cromado. Cartucho 35. Chromed finish. Cartridge 35

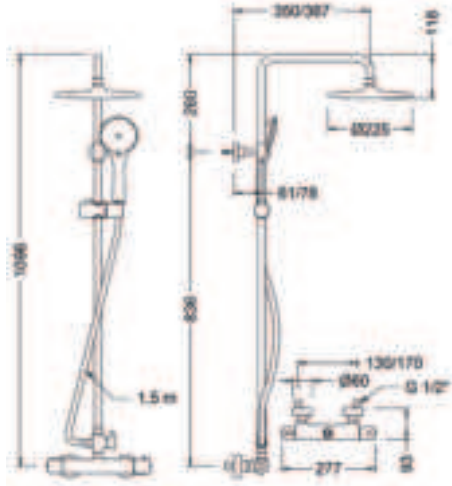

Ref.: CT67110 19

Box: 1 | Carton: 4 | Pallet: 24



Serie Oslo Black



Ref.: 65130 19 41 66

Box: 1 | Carton: 12 | Pallet: 192

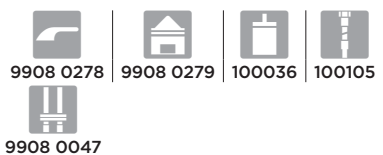

Ref.: 65134 19 41 66

Box: 1 | Carton: 10 | Pallet: 80

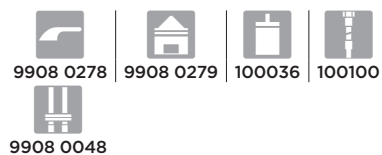

Ref.: 65136 19 41 66

Box: 1 | Carton: 10 | Pallet: 80



Serie Oslo Black

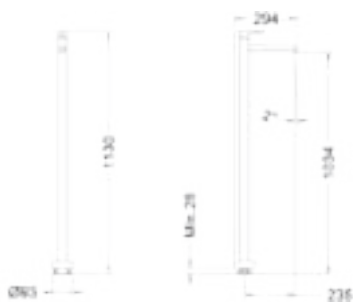

Ref.: 65139 19 41 66

Box: 1 | Carton: 2 | Pallet: 12



9908 0278 | 9908 0279 | 100053

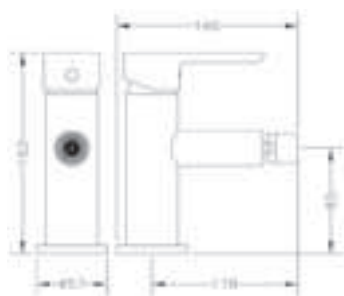

Ref.: 65140 19 41 66

Box: 1 | Carton: 12 | Pallet: 192



9908 0278 | 9908 0281 | 100054 | 100105 | 9908 0050

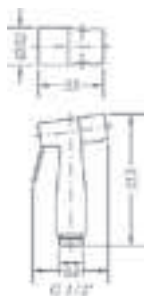

Ref.: 100694 41

Box: 1 | Carton: 22 | Pallet: 264

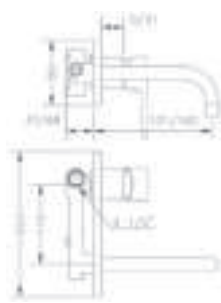

Ref.: 65131 19 41 66

Box: 1 | Carton: 6 | Pallet: 144



9908 0278 | 9908 0290 | 9908 0244 | 100053



9908 0228

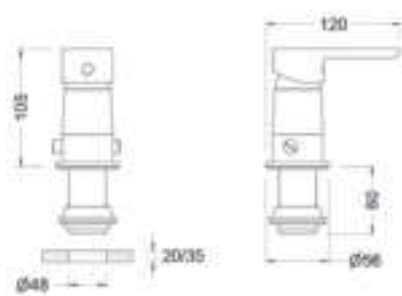

Ref.: 65142 19 41 66

Box: 1 | Carton: 12 | Pallet: 288



9908 0278 | DB142 41 | 100053 | 100111 | 100104



J15



Ref.: 65100 19 41 66

Box: 1 | Carton: 8 | Pallet: 96



9908 0278 | 100126 41 | DXL3 41 | 100135 41 00



9908 0286 | 100085 41 | 100054 | 9908 0288



Ref.: 65132 19 41 66

Box: 1 | Carton: 6 | Pallet: 144



9908 0278 | 9908 0291 | 9908 0244 | 100053



9908 0228

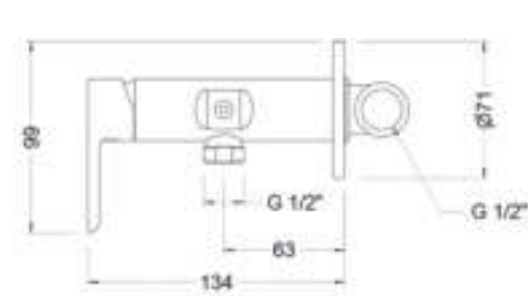

Ref.: 65144 19 41 67

Box: 1 | Carton: 20 | Pallet: 640



9908 0459 | 9908 0461 | 100041 | 9908 0462



9908 0460



Ref.: 65110 19 41 66

Box: 1 | Carton: 8 | Pallet: 96



9908 0278 | 100126 41 | DXL3 41 | 100135 41 00



9908 0286 | 100054

Serie Oslo Black

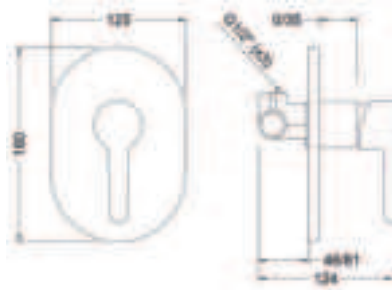

Ref.: 65115 19 41 66

Box: 1 | Carton: 12 | Pallet: 324

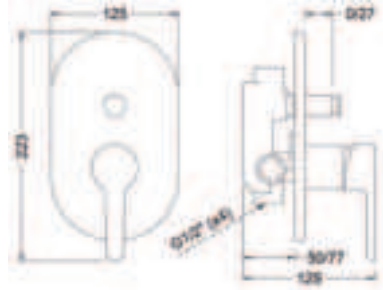

Ref.: 65116 19 41 66

Box: 1 | Carton: 12 | Pallet: 216

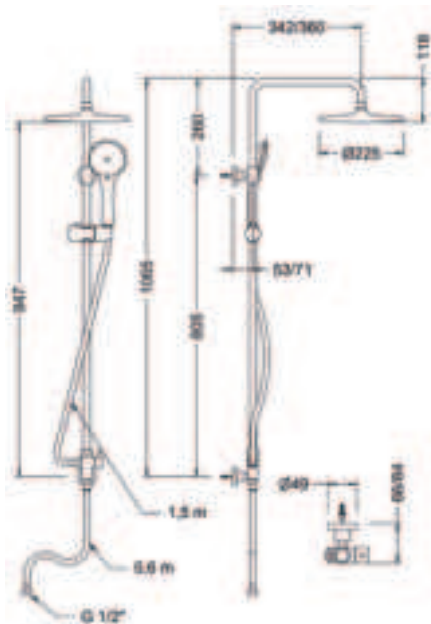

Ref.: 1744 41

Box: 1 | Carton: 4 | Pallet: 24

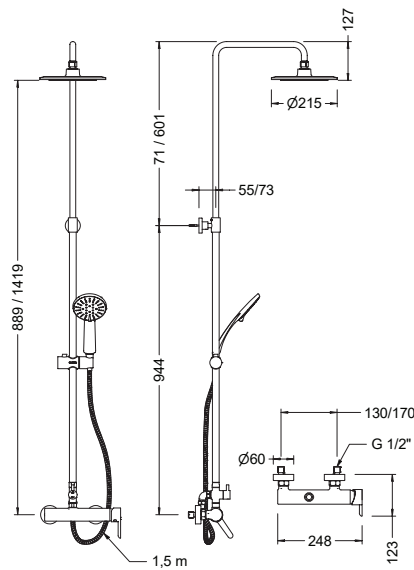
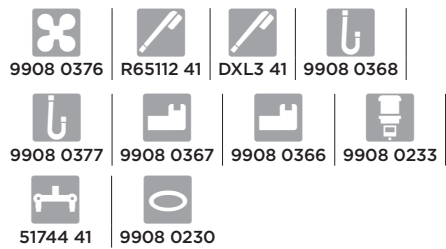

Ref.: CM65111 19 41

Box: 1 | Carton: 2 | Pallet: 12

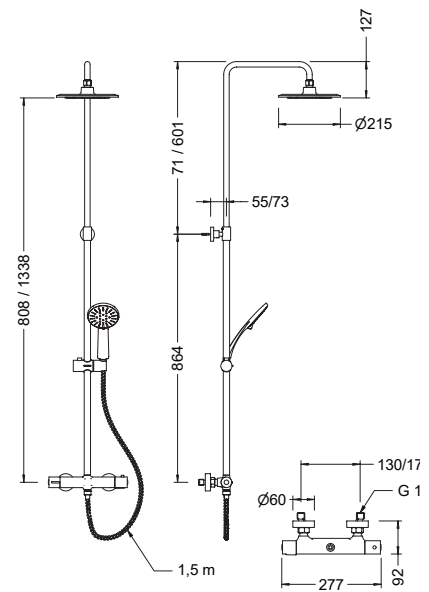
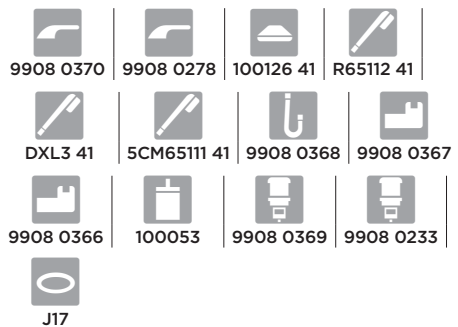

Ref.: CT67111 19 41

Box: 1 | Carton: 2 | Pallet: 12



Serie Klip Acabado cromado. Cartucho 40. Chromed finish. Cartridge 40



Ref.: 64150 16 45 66

Box: 1 | Carton: 12 | Pallet: 288



Ref.: 64136 16 45 66

Box: 1 | Carton: 6 | Pallet: 108



Ref.: 64140 16 45 66

Box: 1 | Carton: 8 | Pallet: 480



Ref.: 64130 16 45 66

Box: 1 | Carton: 12 | Pallet: 216



Ref.: 64131 16 45 66

Box: 1 | Carton: 6 | Pallet: 108



Ref.: 64142 16 45 66

Box: 1 | Carton: 12 | Pallet: 288

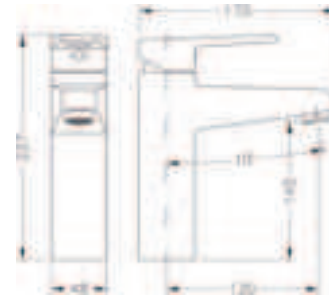

Ref.: 64134 16 45 66

Box: 1 | Carton: 10 | Pallet: 180



Ref.: 64132 16 45 66

Box: 1 | Carton: 6 | Pallet: 108



Ref.: 64100 16 45 66

Box: 1 | Carton: 8 | Pallet: 96



Serie Klip Acabado cromado. Cartucho 40. Chromed finish. Cartridge 40



Ref.: 64110 16 45 66

Box: 1 | Carton: 8 | Pallet: 96

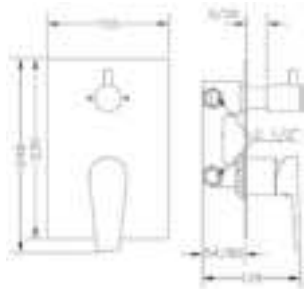
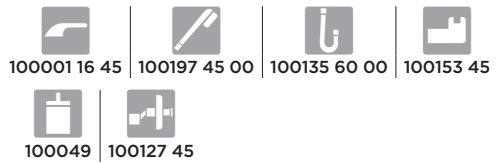

Ref.: 64117 04 45 66

Box: 1 | Carton: 6 | Pallet: 108



Ref.: 67103 14 45 67

Box: 1 | Carton: 6 | Pallet: 108

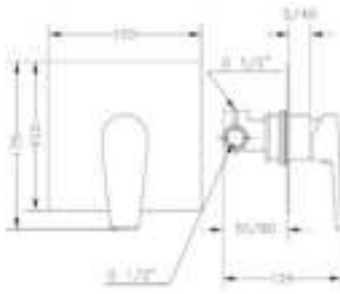
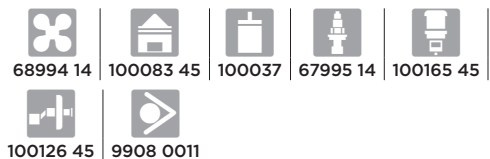

Ref.: 64115 16 45 66

Box: 1 | Carton: 12 | Pallet: 216

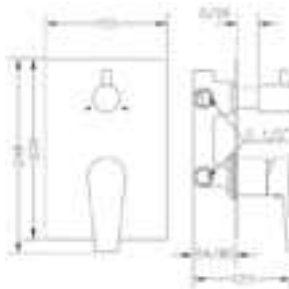

Ref.: 64118 04 45 66

Box: 1 | Carton: 6 | Pallet: 108

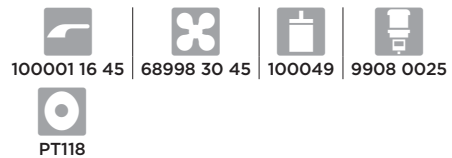

Ref.: 67104 14 45 67

Box: 1 | Carton: 11 | Pallet: 264

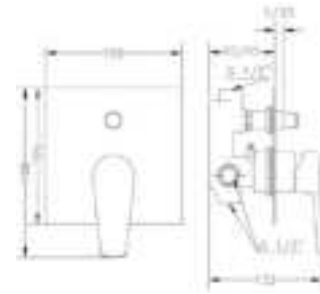

Ref.: 64116 16 45 66

Box: 1 | Carton: 12 | Pallet: 216



Ref.: 65114 30 45 66

Box: 1 | Carton: 8 | Pallet: 288



Serie Tau Acabado cromado. Cartucho 40. Chromed finish. Cartridge 40

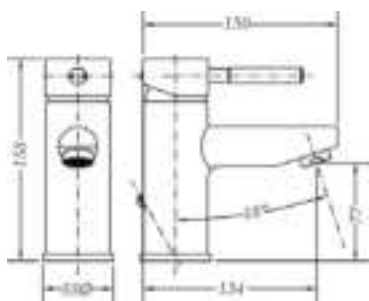

Ref.: 65135 18 45 66

Box: 1 | Carton: 12 | Pallet: 216

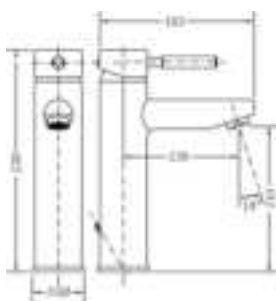

Ref.: 65134 18 45 66

Box: 1 | Carton: 10 | Pallet: 240

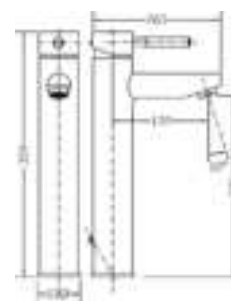

Ref.: 65136 18 45 66

Box: 1 | Carton: 6 | Pallet: 108

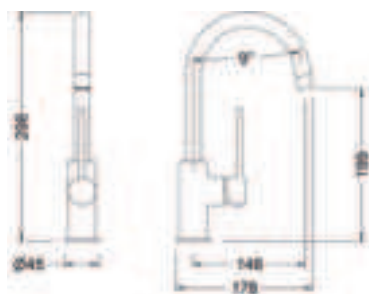

Ref.: 65138 18 45 66

Box: 1 | Carton: 10 | Pallet: 120

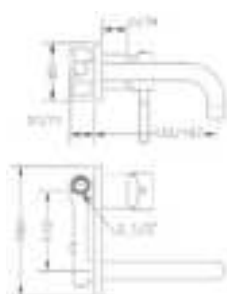

Ref.: 65131 18 45 66

Box: 1 | Carton: 6 | Pallet: 108



Ref.: 65132 18 45 66

Box: 1 | Carton: 6 | Pallet: 144

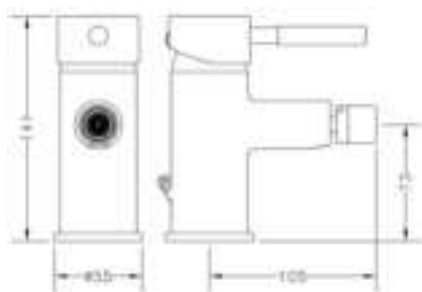

Ref.: 65145 18 45 66

Box: 1 | Carton: 8 | Pallet: 384

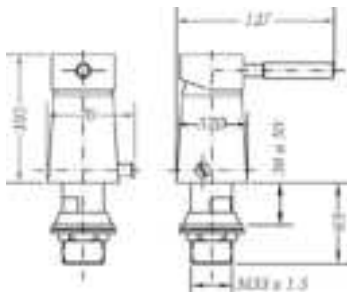

Ref.: 65142 18 45 66

Box: 1 | Carton: 12 | Pallet: 288

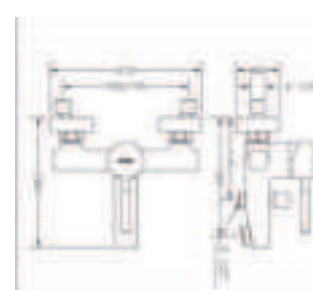

Ref.: 65100 18 45 66

Box: 1 | Carton: 6 | Pallet: 108

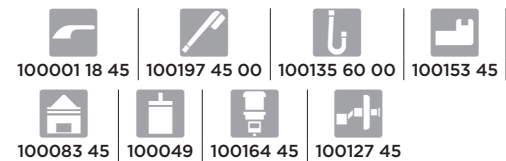

Serie Tau Acabado cromado. Cartucho 40. Chromed finish. Cartridge 40



Ref.: 65110 18 45 66

Box: 1 | Carton: 6 | Pallet: 108

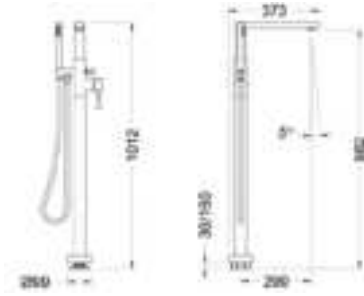

Ref.: 65119 18 45 66

Box: 1 | Carton: 2 | Pallet: 12

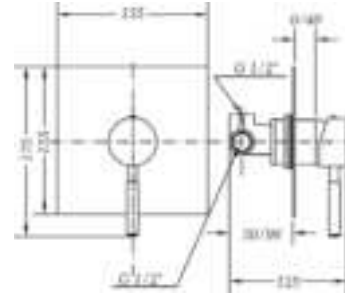

Ref.: 65115 18 45 66

Box: 1 | Carton: 12 | Pallet: 216

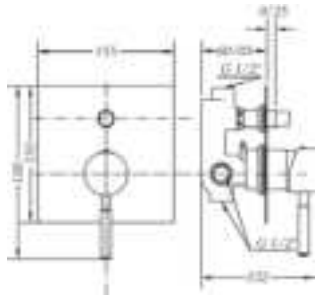

Ref.: 65116 18 45 66

Box: 1 | Carton: 12 | Pallet: 216

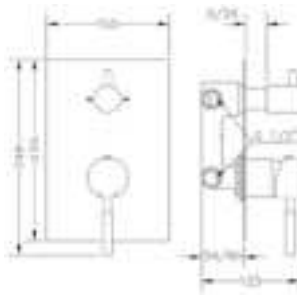

Ref.: 65117 18 45 66

Box: 1 | Carton: 6 | Pallet: 108

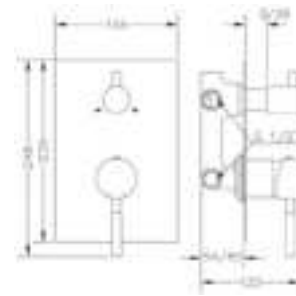
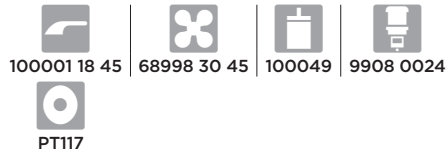

Ref.: 65118 18 45 66

Box: 1 | Carton: 6 | Pallet: 108

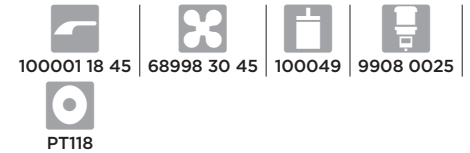

Ref.: 65114 30 45 66

Box: 1 | Carton: 8 | Pallet: 288

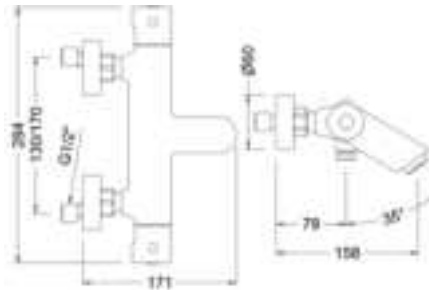

Ref.: 67102 14 45 67

Box: 1 | Carton: 6 | Pallet: 144



Ref.: 67112 14 45 67

Box: 1 | Carton: 12 | Pallet: 288



Serie Tau Acabado cromado. Cartucho 40. Chromed finish. Cartridge 40

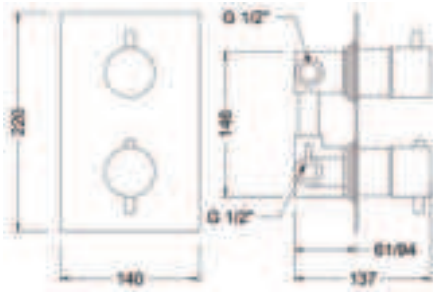

Ref.: 64114 14 45 67

Box: 1 | Carton: 4 | Pallet: 72

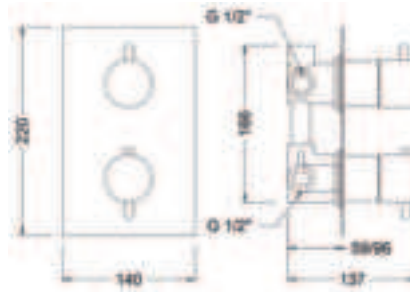
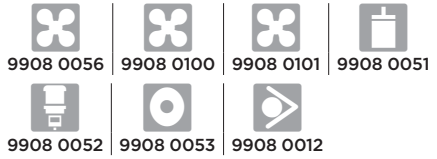

Ref.: 64111 14 45 67

Box: 1 | Carton: 4 | Pallet: 72

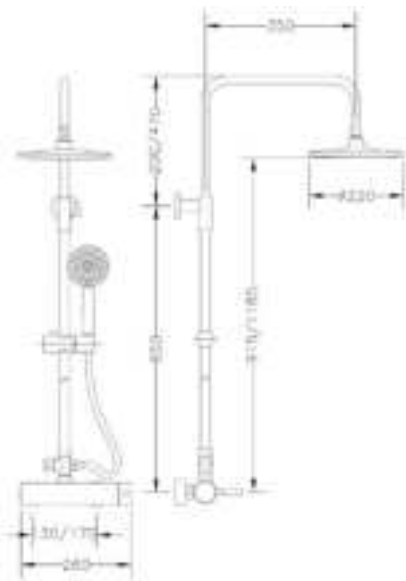
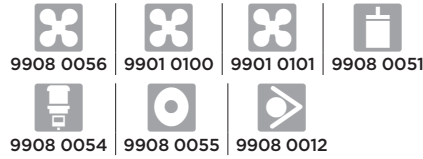

Ref.: CM65110 18

Box: 1 | Carton: 2 | Pallet: 24

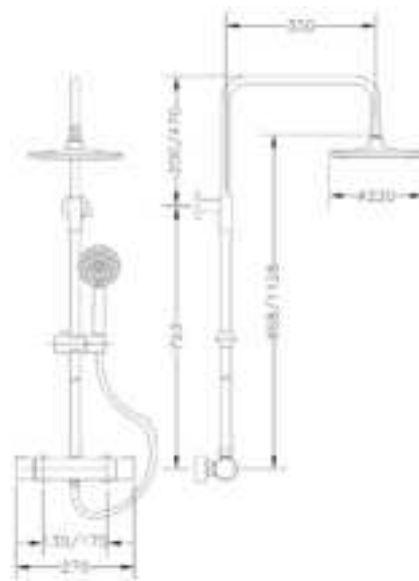
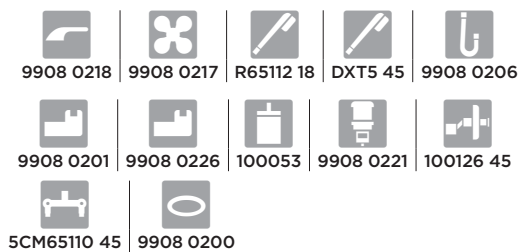

Ref.: CT67110 18

Box: 1 | Carton: 2 | Pallet: 24

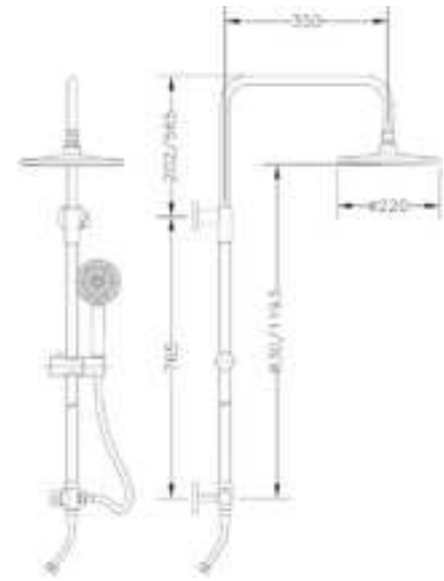

Ref.: 1745 45

Box: 1 | Carton: 2 | Pallet: 24

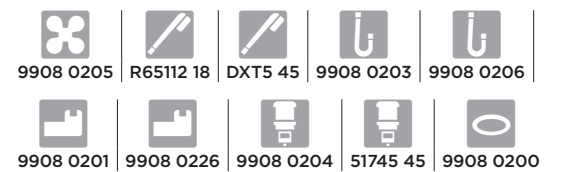

Serie Tau2 Acabado cromado. Cartucho 40. Chromed finish. Cartridge 40

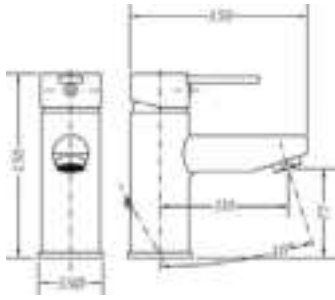

Ref.: 65135 29 45 66

Box: 1 | Carton: 12 | Pallet: 216

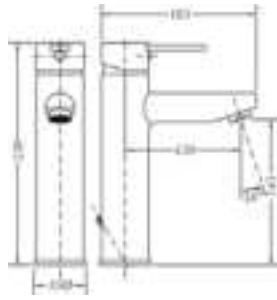

Ref.: 65134 29 45 66

Box: 1 | Carton: 10 | Pallet: 180

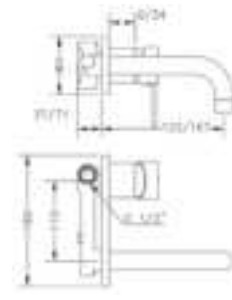

Ref.: 65131 29 45 66

Box: 1 | Carton: 6 | Pallet: 144



PT131

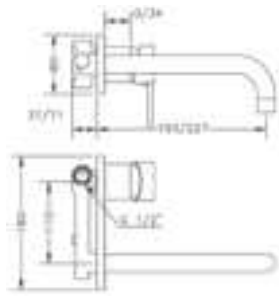

Ref.: 65132 29 45 66

Box: 1 | Carton: 6 | Pallet: 144

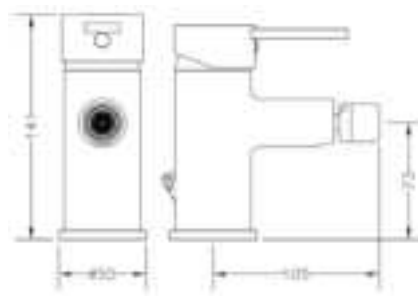

Ref.: 65145 29 45 66

Box: 1 | Carton: 8 | Pallet: 384

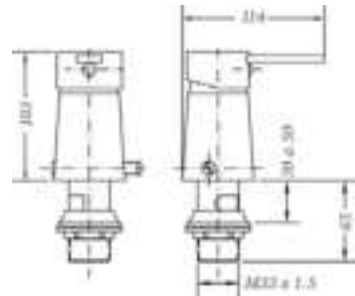

Ref.: 65142 29 45 66

Box: 1 | Carton: 12 | Pallet: 288



J15



Ref.: 65100 29 45 66

Box: 1 | Carton: 6 | Pallet: 108



Ref.: 65110 29 45 66

Box: 1 | Carton: 6 | Pallet: 108



Ref.: 65119 29 45 66

Box: 1 | Carton: 2 | Pallet: 8



Serie Kenjo Acabado cromado. Cartucho 35. Chromed finish. Cartridge 35

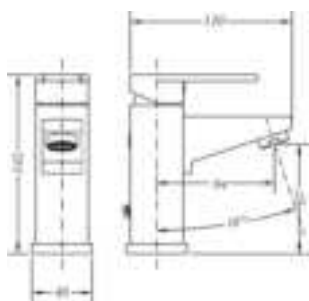

Ref.: 63130 26 45 66
Box: 1 | Carton: 20 | Pallet: 360

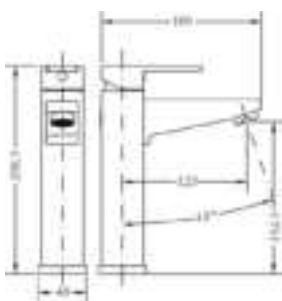

Ref.: 63134 26 45 66
Box: 1 | Carton: 8 | Pallet: 192

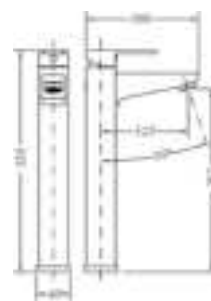

Ref.: 63136 26 45 66
Box: 1 | Carton: 6 | Pallet: 108

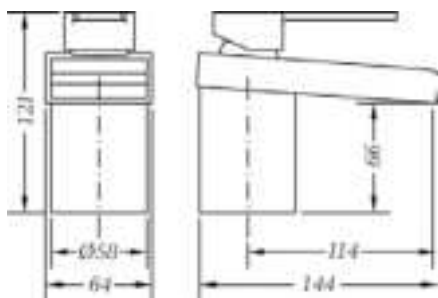

Ref.: 63137 26 45 66
Box: 1 | Carton: 20 | Pallet: 360

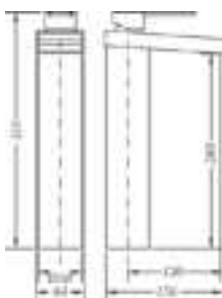

Ref.: 63138 26 45 66
Box: 1 | Carton: 6 | Pallet: 108



Ref.: 63131 26 45 66
Box: 1 | Carton: 6 | Pallet: 108

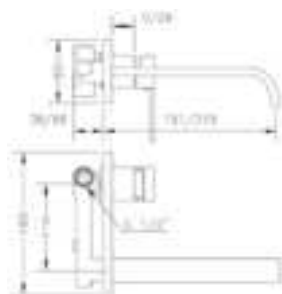

Ref.: 63132 26 45 66
Box: 1 | Carton: 6 | Pallet: 108

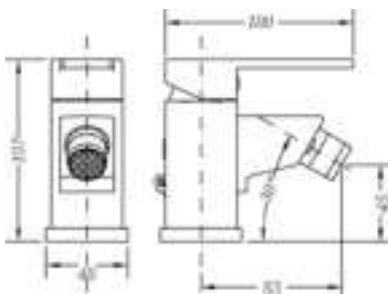

Ref.: 63140 26 45 66
Box: 1 | Carton: 8 | Pallet: 384



Ref.: 63142 26 45 66
Box: 1 | Carton: 12 | Pallet: 216



Serie Kenjo Acabado cromado. Cartucho 35. Chromed finish. Cartridge 35



Ref.: 63100 26 45 67
Box: 1 | Carton: 6 | Pallet: 162

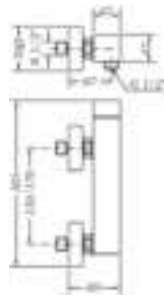
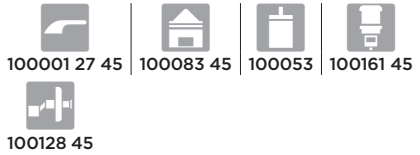

Ref.: 63110 26 45 67
Box: 1 | Carton: 10 | Pallet: 180

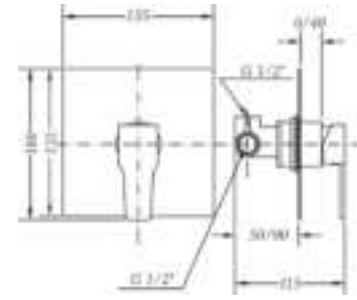

Ref.: 63115 26 45 66
Box: 1 | Carton: 12 | Pallet: 216

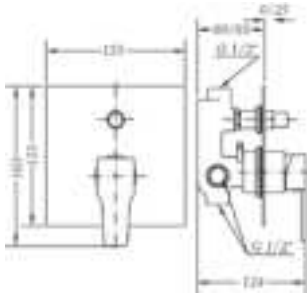

Ref.: 63116 26 45 66
Box: 1 | Carton: 12 | Pallet: 216

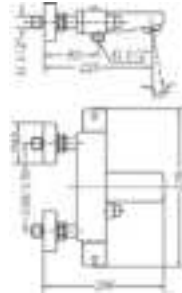

Ref.: 67100 26 45 67
Box: 1 | Carton: 6 | Pallet: 144



Ref.: 67110 26 45 67
Box: 1 | Carton: 9 | Pallet: 216

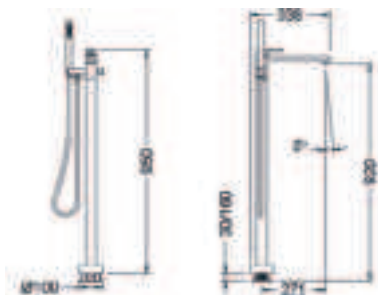

Ref.: 63119 26 45 66
Box: 1 | Carton: 2 | Pallet: 12



Serie Kenjo Acabado cromado. Cartucho 35. Chromed finish. Cartridge 35

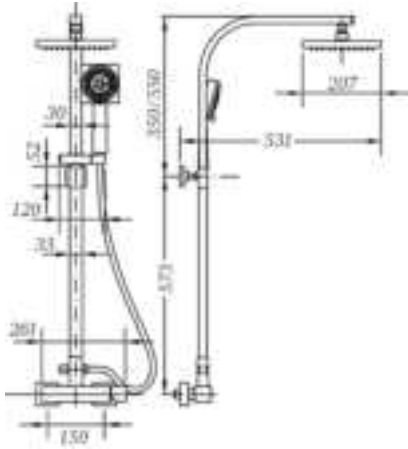

Ref.: CM63110 26

Box: 1 | Carton: 2 | Pallet: 24

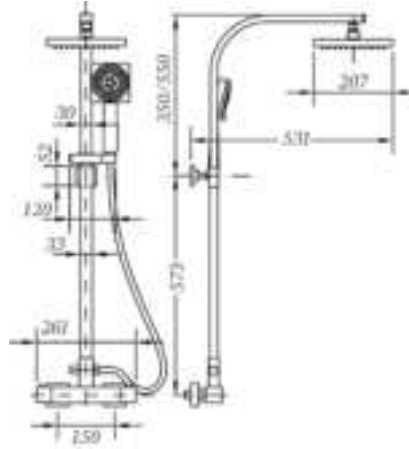

Ref.: CT67110 26

Box: 1 | Carton: 2 | Pallet: 24

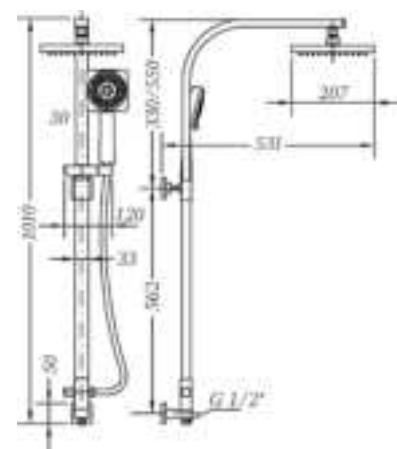

Ref.: 1746 45

Box: 1 | Carton: 2 | Pallet: 24



Serie K8 Acabado cromado. Cartucho 40. Chromed finish. Cartridge 40

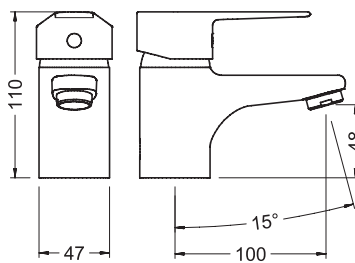

Ref.: 60150 28 45 66

Box: 1 | Carton: 21 | Pallet: 420

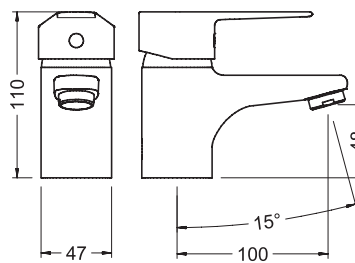
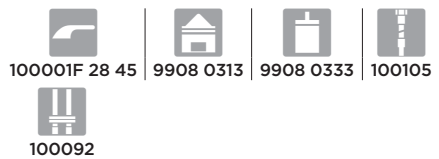

Ref.: 60130 28 45 66

Box: 1 | Carton: 21 | Pallet: 420

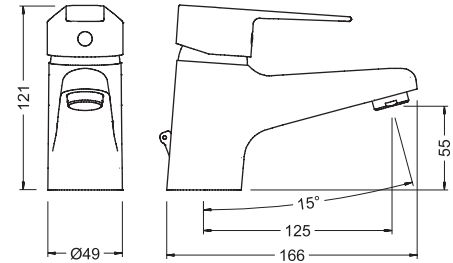
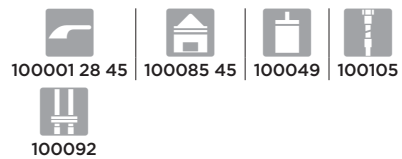

Ref.: 61150 28 45 66

Box: 1 | Carton: 21 | Pallet: 336



Serie K8 Acabado cromado. Cartucho 40. Chromed finish. Cartridge 40

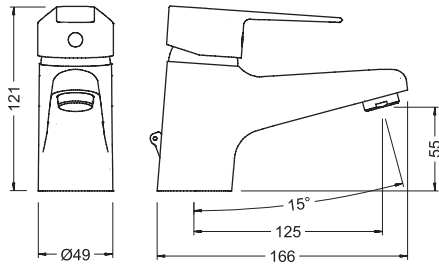

Ref.: 61130 28 45 66

Box: 1 | Carton: 21 | Pallet: 336



100001 28 45 | 100085 45 | 100049 | 100105 | 100092

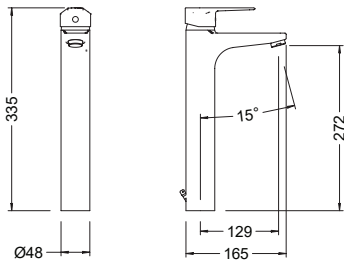

Ref.: 60136 28 45 66

Box: 1 | Carton: 10 | Pallet: 120



100001 28 45 | 100085 45 | 100049 | 100129 | 9908 0265

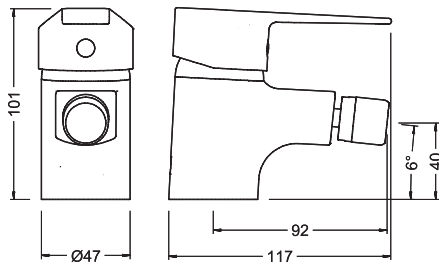

Ref.: 60140 28 45 66

Box: 1 | Carton: 8 | Pallet: 480



100001 28 45 | 100086 45 | 100049 | 100103 | 100092

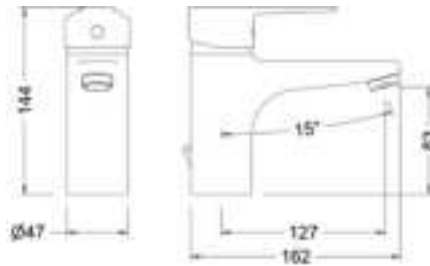

Ref.: 60154 28 45 66

Box: 1 | Carton: 6 | Pallet: 240



100001F 28 45 | 9908 0313 | 9908 0333 | 100105



9908 0265

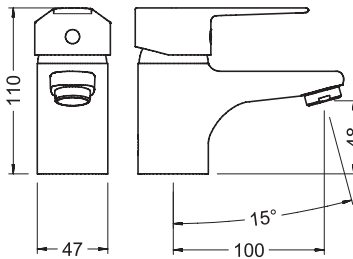

Ref.: 60130 28 45 66

Box: 1 | Carton: 21 | Pallet: 420



100001 28 45 | 100085 45 | 100049 | 100105 | 100092

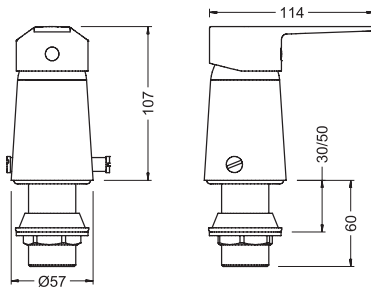

Ref.: 61142 28 45 66

Box: 1 | Carton: 12 | Pallet: 288



100001 28 45 | DB142 45 | 100051 | 100111 | 100104



J15

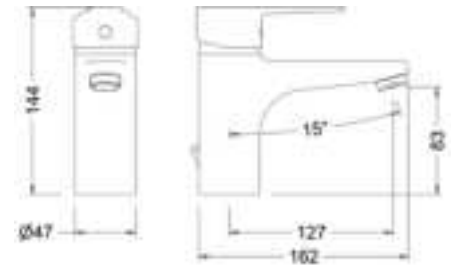

Ref.: 60134 28 45 66

Box: 1 | Carton: 6 | Pallet: 240



100001 28 45 | 100085 45 | 100049 | 100105



9908 0265

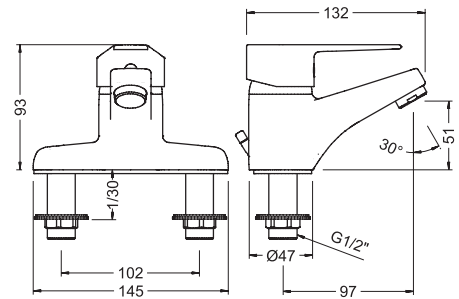

Ref.: 60188 28 45 66

Box: 1 | Carton: 12 | Pallet: 216



100001 28 45 | 100085 45 | 100049 | 100098

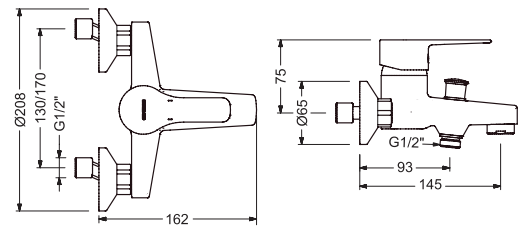

Ref.: 60100 28 45 66

Box: 1 | Carton: 8 | Pallet: 128



100001 28 45 | 100175 45 00 | 100135 60 00 | 100152 45 00



100083 45 | 100049 | 100160 45 | 100125 45

Serie K8 Acabado cromado. Cartucho 40. Chromed finish. Cartridge 40

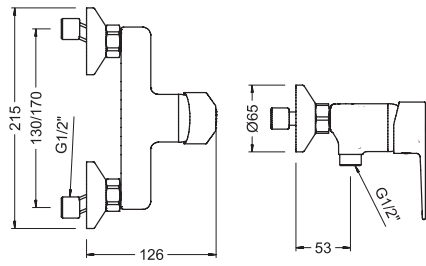

Ref.: 60110 28 45 66

Box: 1 | Carton: 10 | Pallet: 160

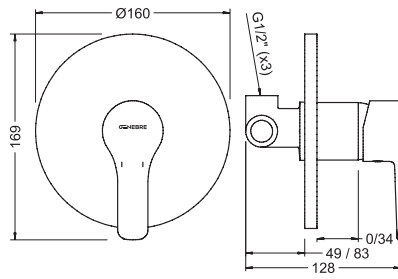
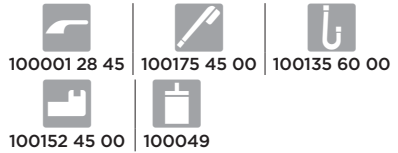

Ref.: 61115 28 45 66

Box: 1 | Carton: 12 | Pallet: 216

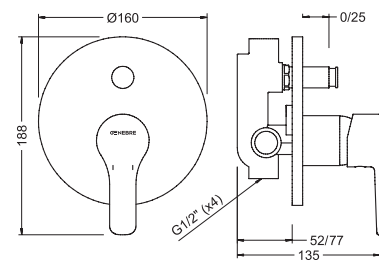

Ref.: 61116 28 45 66

Box: 1 | Carton: 12 | Pallet: 216



Serie Ge2 Acabado cromado. Cartucho 40. Chromed finish. Cartridge 40

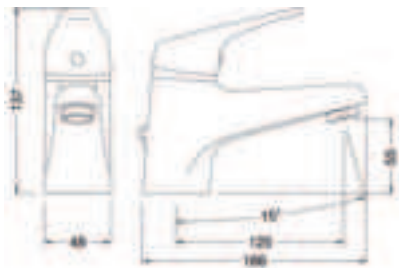

Ref.: 61130 22 45 66

Box: 1 | Carton: 8 | Pallet: 320

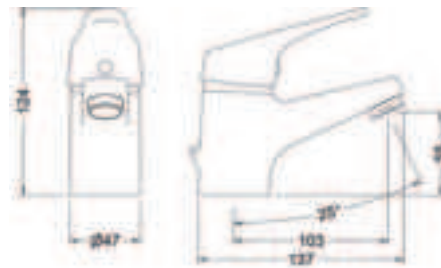

Ref.: 60130 22 45 66

Box: 1 | Carton: 20 | Pallet: 540

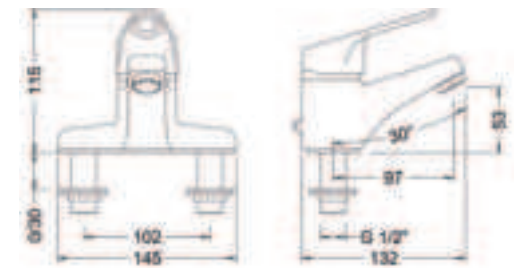

Ref.: 60188 22 45 66

Box: 1 | Carton: 12 | Pallet: 216

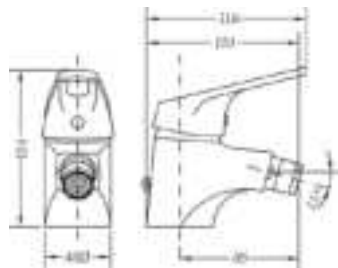

Ref.: 60140 22 45 66

Box: 1 | Carton: 8 | Pallet: 480

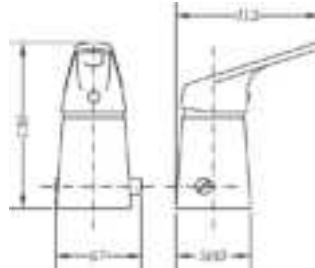

Ref.: 61142 22 45 66

Box: 1 | Carton: 12 | Pallet: 288



Serie Ge2 Acabado cromado. Cartucho 40. Chromed finish. Cartridge 40

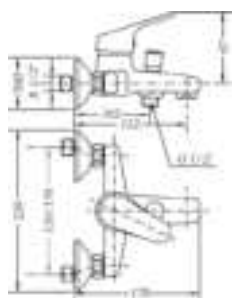

Ref.: 60100 22 45 66

Box: 1 | Carton: 8 | Pallet: 128

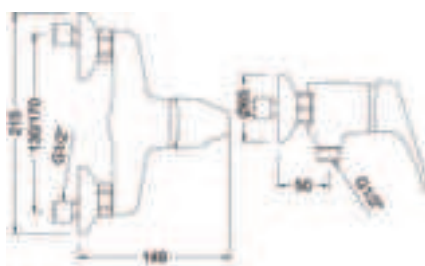
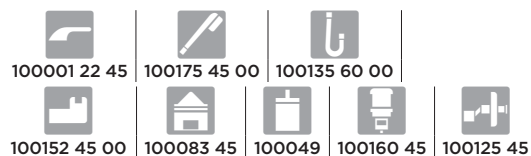

Ref.: 60110 22 45 66

Box: 1 | Carton: 8 | Pallet: 160

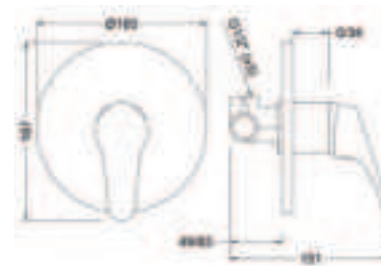
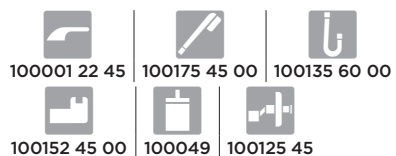

Ref.: 61115 22 45 66

Box: 1 | Carton: 12 | Pallet: 216

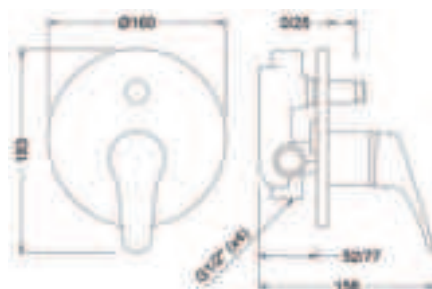

Ref.: 61116 22 45 66

Box: 1 | Carton: 12 | Pallet: 216

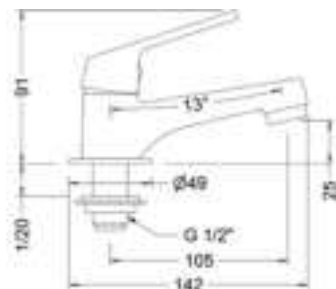

Ref.: 1002 04

Box: 1 | Carton: 42 | Pallet: 840

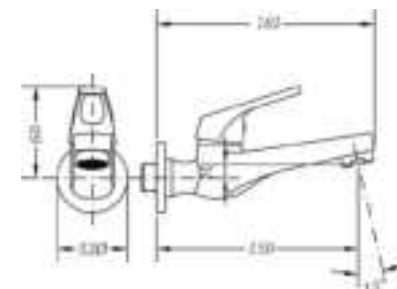

Ref.: 1003 04

Box: 1 | Carton: 48 | Pallet: 864



Ref.: 1009 04

Box: 1 | Carton: 30 | Pallet: 540

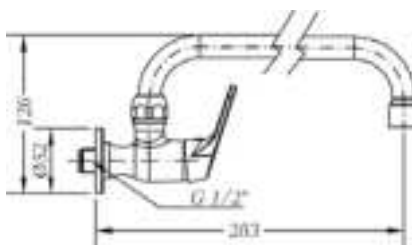

Ref.: 1008 04

Box: 1 | Carton: 42 | Pallet: 504



Ref.: 1005 04

Box: 1 | Carton: 42 | Pallet: 504



Serie Ge2 Acabado cromado. Cartucho 40. Chromed finish. Cartridge 40



Ref.: 1023 04

Box: 1 | Carton: 48 | Pallet: 864



68998 28 45 | 68995 09

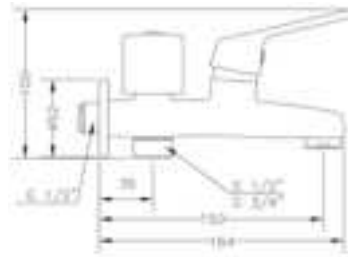

Ref.: 1024 04

Box: 1 | Carton: 22 | Pallet: 704



100001 33 45 | 68998 28 45 | 100085 45 | 100042



68995 09

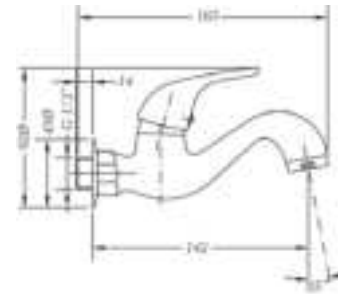

Ref.: 1006 04

Box: 1 | Carton: 36 | Pallet: 864



100085 45 | 100042



Ref.: 1007 04

Box: 1 | Carton: 22 | Pallet: 704



100085 45 | 100042 | 100098

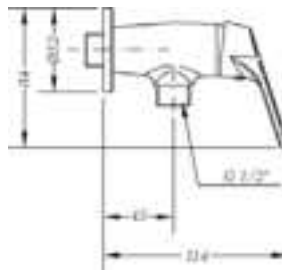

Ref.: 60001 22 45 67

Box: 1 | Carton: 54 | Pallet: 972



100001 33 45 | 100042

Serie New Regent Classic Montura 1/4 vuelta cierre cerámico. Ceramic headwork quarter turn

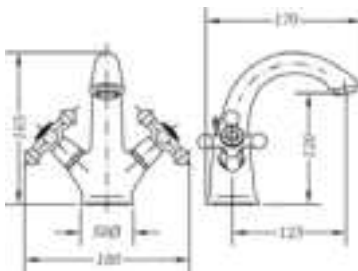

Ref.: 68506 09 45 66

Box: 1 | Carton: 8 | Pallet: 144



68998 09 45 | 100085 45 | 68995 09 | 100103 | 100090

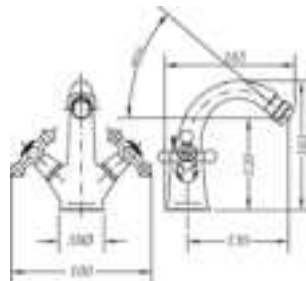

Ref.: 68516 09 45 66

Box: 1 | Carton: 8 | Pallet: 144



68998 09 45 | 100086 45 | 68995 09 | 100103 | 100090

Serie New Regent Classic Montura 1/4 vuelta cierre cerámico. Ceramic headwork quarter turn

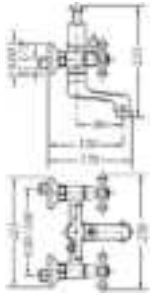

Ref.: 68526 09 45 66

Box: 1 | Carton: 4 | Pallet: 72

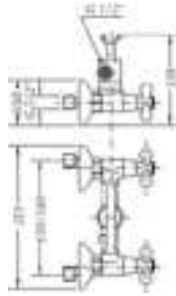

Ref.: 68531 09 45 66

Box: 1 | Carton: 8 | Pallet: 96

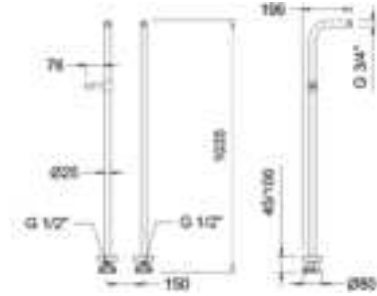
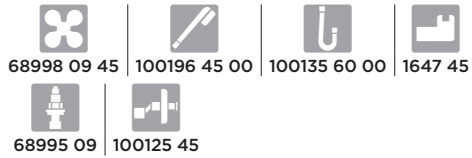

Ref.: 65120 45

Box: 1 | Carton: 2 | Pallet: 24

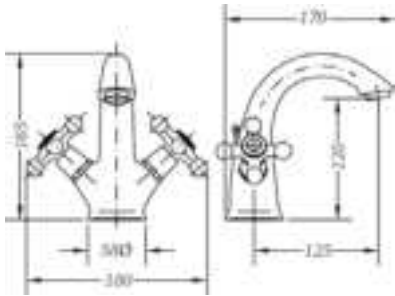

Ref.: 68506 09 43 66

Box: 1 | Carton: 8 | Pallet: 144

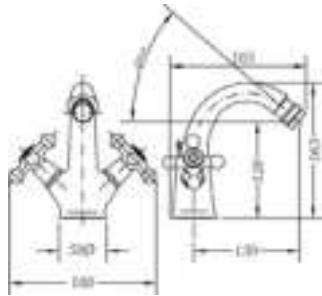
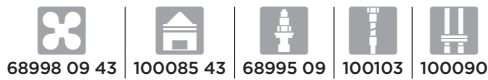

Ref.: 68516 09 43 66

Box: 1 | Carton: 8 | Pallet: 144

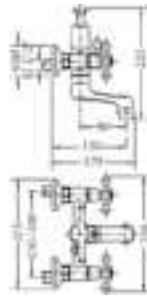
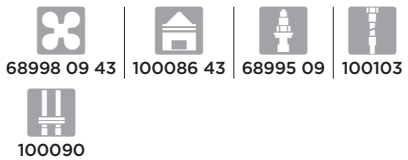

Ref.: 68526 09 43 66

Box: 1 | Carton: 4 | Pallet: 72

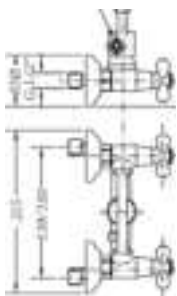
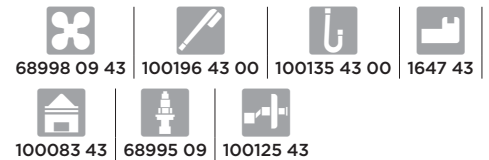

Ref.: 68531 09 43 66

Box: 1 | Carton: 8 | Pallet: 96

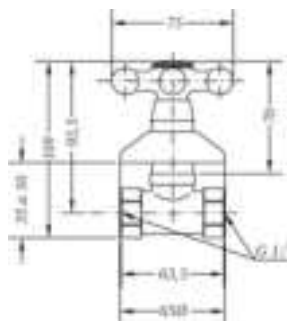

Ref.: 68590 09 43 66

Box: 1 | Carton: 24 | Pallet: 576



Serie New Regent Classic Acabado cromado. Montura 1/4 vuelta cierre cerámico. Chromed finish. Ceramic headwork quarter turn

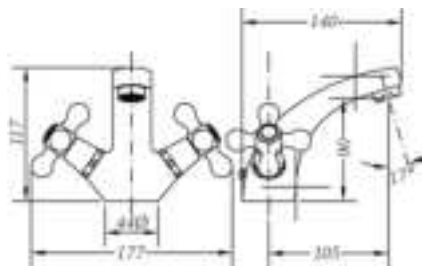

Ref.: 68505 09 45 66

Box: 1 | Carton: 12 | Pallet: 216



68998 09 45 | 100085 45 | 68995 09 | 100103 | 100090

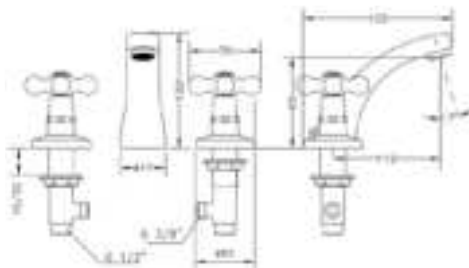

Ref.: 68510 09 45 66

Box: 1 | Carton: 10 | Pallet: 240



68998 09 45 | 100085 45 | 68995 09 | 100103



100090

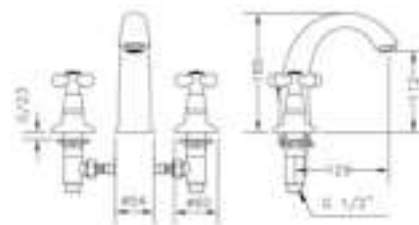

Ref.: 68120 09 45 66

Box: 1 | Carton: 6 | Pallet: 240



68998 09 45 | 100085 45 | 68995 09 | 100103

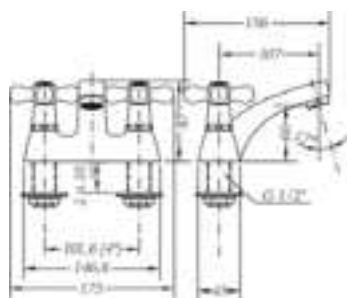

Ref.: 68511 09 45 66

Box: 1 | Carton: 12 | Pallet: 216



68998 09 45 | 100085 45 | 68995 09 | 100098

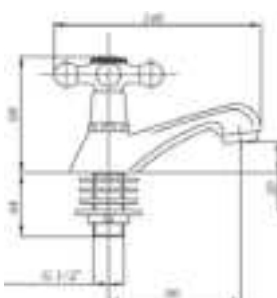

Ref.: 68500 09 45 66

Box: 1 | Carton: 24 | Pallet: 576



68998 09 45 | 100085 45 | 68995 09 | 100098

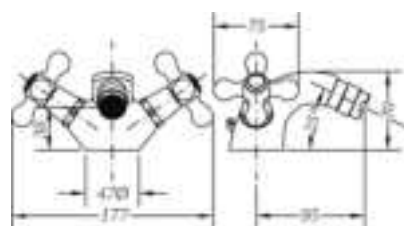

Ref.: 68515 09 45 66

Box: 1 | Carton: 12 | Pallet: 216



68998 09 45 | 100086 45 | 68995 09 | 100103 | 100090

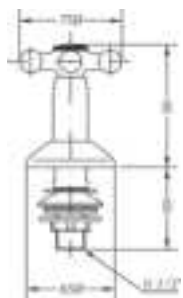

Ref.: 68520 09 45 66

Carton: 24



68998 09 45 | 68995 09

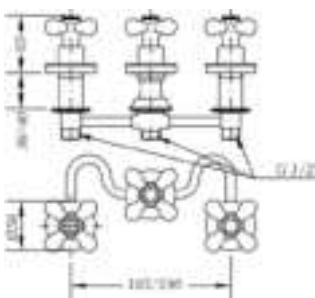

Ref.: 68142 09 45 66

Box: 1 | Carton: 10 | Pallet: 240



68998 09 45 | DB142 45 | 67895 45 | 100174 45

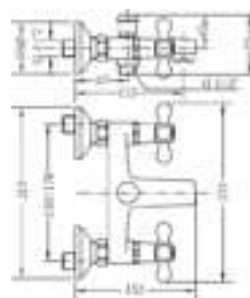

Ref.: 68525 09 45 66

Box: 1 | Carton: 12 | Pallet: 216

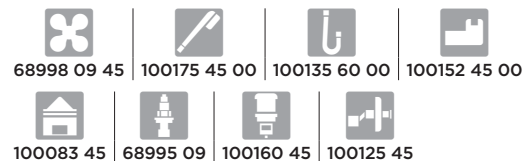

68998 09 45 | 100175 45 00 | 100135 60 00 | 100152 45 00

100083 45 | 68995 09 | 100160 45 | 100125 45

Serie New Regent Classic Acabado cromado. Montura 1/4 vuelta cierre cerámico. Chromed finish. Ceramic headwork quarter turn

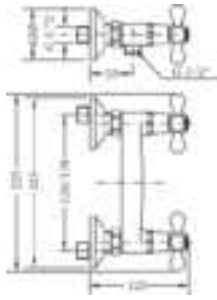

Ref.: 68530 09 45 66

Box: 1 | Carton: 12 | Pallet: 216

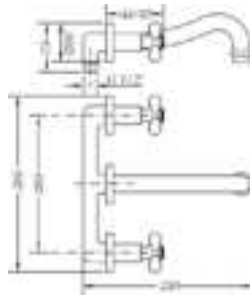
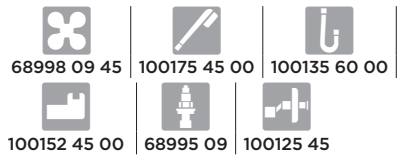

Ref.: 68131 09 45 66

Box: 1 | Carton: 10 | Pallet: 240

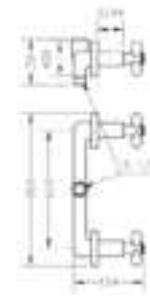
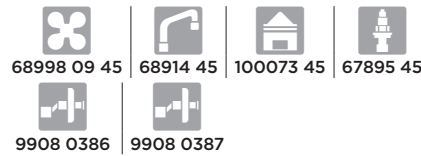

Ref.: 68535 09 45 66

Box: 1 | Carton: 10 | Pallet: 240

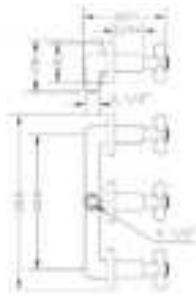

Ref.: 68527 09 45 66

Box: 1 | Carton: 10

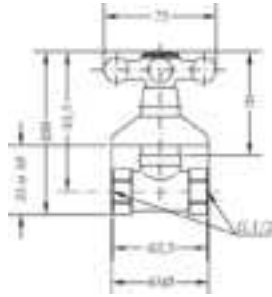
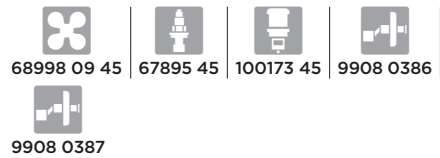

Ref.: 68590 09 45 66

Box: 1 | Carton: 24 | Pallet: 576

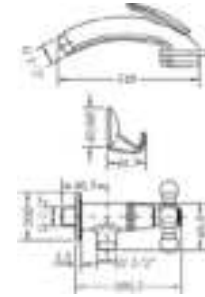

Ref.: 68001 09 45 66

Box: 1 | Carton: 20 | Pallet: 360



Serie Gamma Acabado cromado. Montura convencional. Chromed finish. Conventional headwork

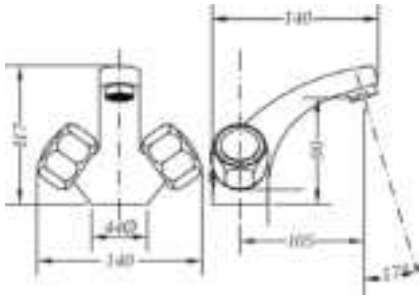

Ref.: 68130 11 45 66

Box: 1 | Carton: 12 | Pallet: 216

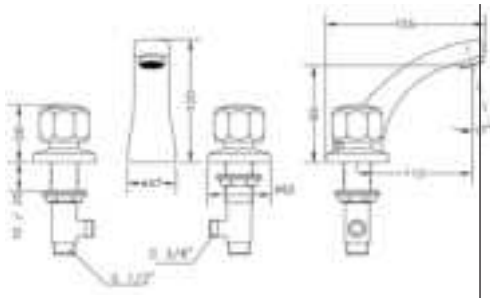
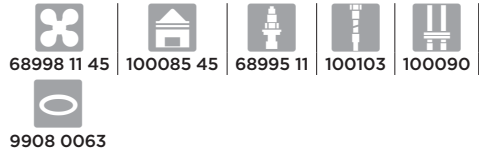

Ref.: 68120 11 45 66

Box: 1 | Carton: 10 | Pallet: 240

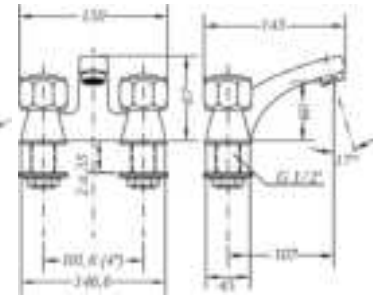
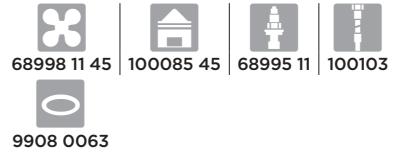

Ref.: 68122 11 45 66

Box: 1 | Carton: 12 | Pallet: 216

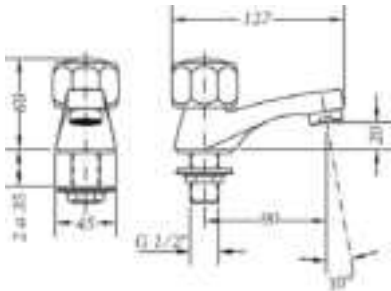

Ref.: 68180 11 45 66

Box: 1 | Carton: 24 | Pallet: 576

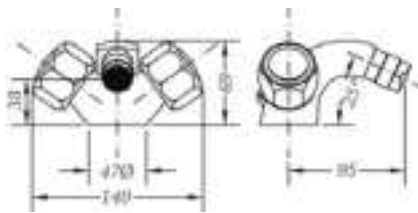

Ref.: 68140 11 45 66

Box: 1 | Carton: 12 | Pallet: 216

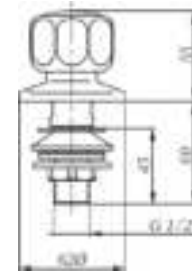
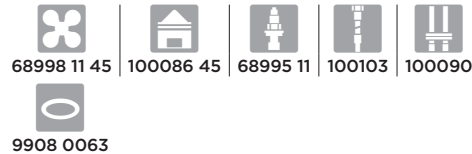

Ref.: 68160 11 45 66

Box: 1 | Carton: 24 | Pallet: 576

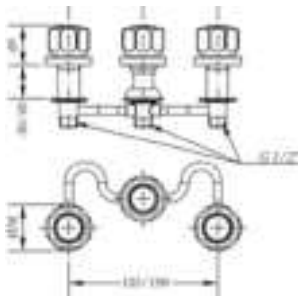

Ref.: 68142 11 45 66

Box: 1 | Carton: 10 | Pallet: 240

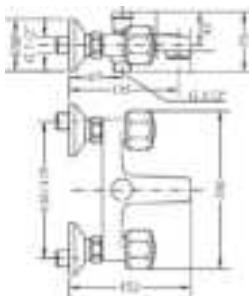

Ref.: 68100 11 45 66

Box: 1 | Carton: 12 | Pallet: 216

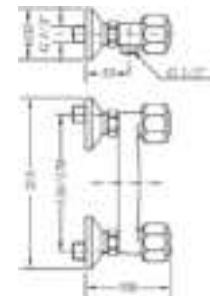
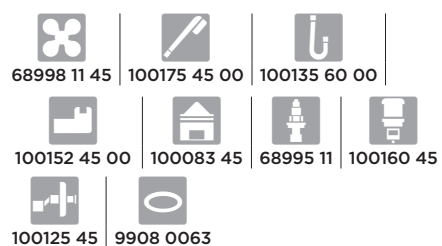

Ref.: 68110 11 45 66

Box: 1 | Carton: 12 | Pallet: 216



Serie Gamma Acabado cromado. Montura convencional. Chromed finish. Conventional headwork

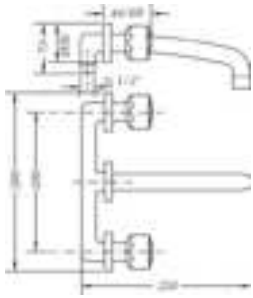

Ref.: 68131 11 45 66

Box: 1 | Carton: 10 | Pallet: 240



Ref.: 68115 11 45 66

Box: 1 | Carton: 10 | Pallet: 240

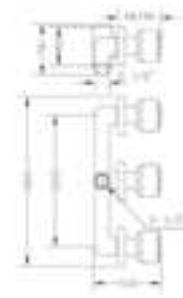

Ref.: 68116 11 45 66

Box: 1 | Carton: 10 | Pallet: 240

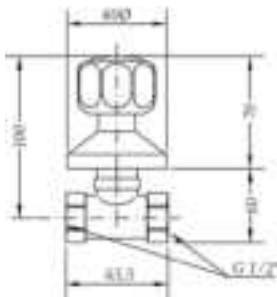

Ref.: 68170 11 45 66

Box: 1 | Carton: 24 | Pallet: 576

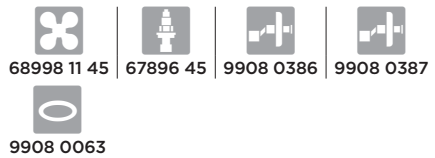

Ref.: 68001 11 45 66

Box: 1 | Carton: 20 | Pallet: 360



Serie Kalo Acabado cromado. Montura 1/4 vuelta cierre cerámico. Chromed finish. Ceramic headwork quarter turn

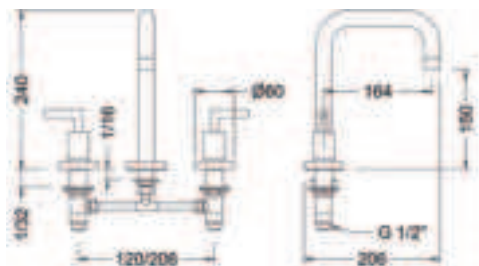

Ref.: 68120 07 45 66

Carton: 1

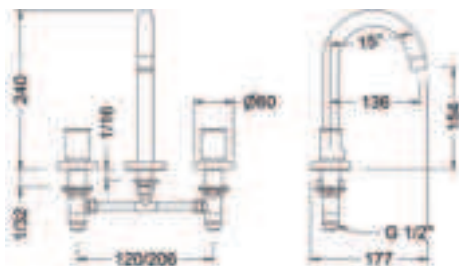
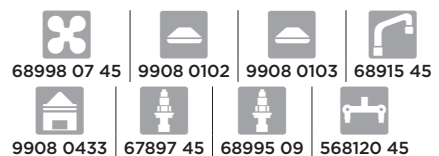

Ref.: 68124 07 45 66

Carton: 1

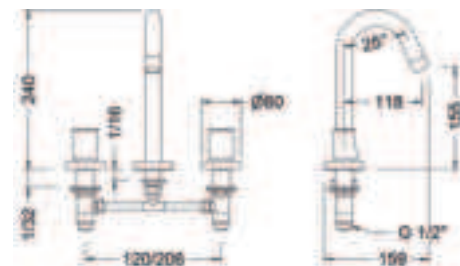
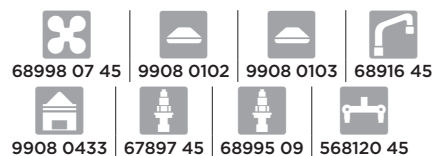

Ref.: 68125 07 45 66

Carton: 1

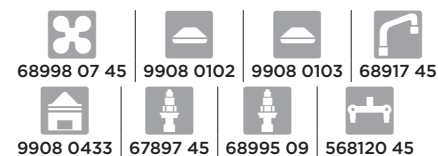

Ref.: 68131 07 45 66

Carton: 1

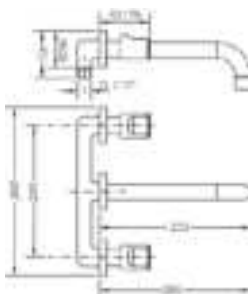

Ref.: 68132 07 45 66

Carton: 1

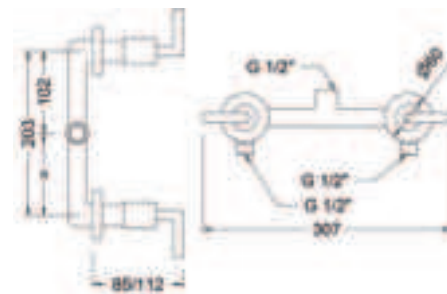

Ref.: 68115 07 45 66

Carton: 1

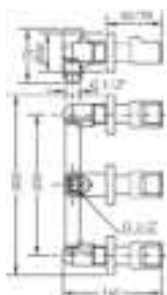
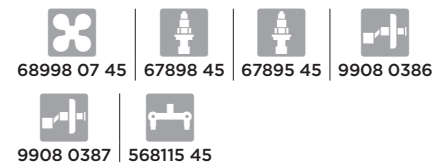

Ref.: 68116 07 45 66

Carton: 1

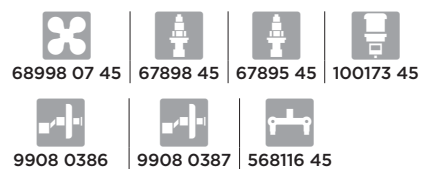

Ref.: 63114 30 45 66

Box: 1 | Carton: 8 | Pallet: 384

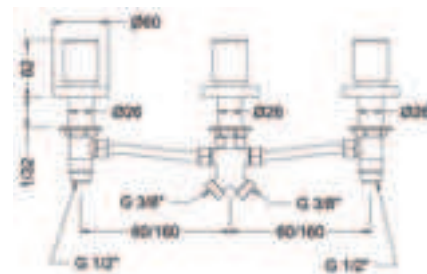

Ref.: 68113 07 45 66

Carton: 1



Serie Kalo Acabado cromado. Montura 1/4 vuelta cierre cerámico. Chromed finish. Ceramic headwork quarter turn

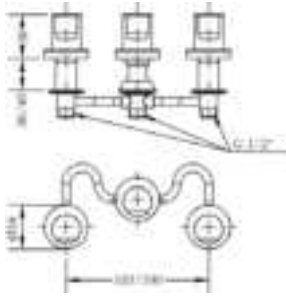

Ref.: 68142 07 45 66

Carton: 1

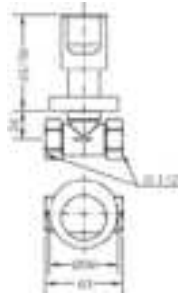
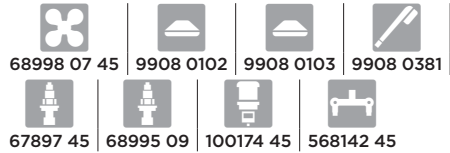

Ref.: 68170 07 45 66

Carton: 1

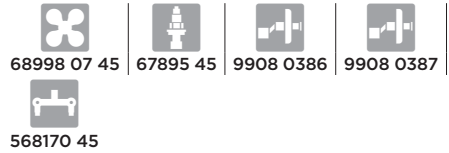

Las series Kalo, Kross e Ixo nacen de la combinación de diferentes componentes: cuerpos, caños y volantes. Busque la combinación que mejor se adapte a su baño. Puede pedirla utilizando la referencia del catálogo (conjunto) o bien por referencia de cada uno de los componentes. En este apartado podrá identificar fácilmente las referencias de cada componente necesario.

The series Kalo, Kross and Ixo are born from the combination of different components: bodies, pipes and handles. Look for the combination that best suits your bathroom. You can order it using the set reference or by components reference. In this section you can easily identify the references of each required component

Serie Kross Acabado cromado. Montura 1/4 vuelta cierre cerámico. Chromed finish. Ceramic headwork quarter turn

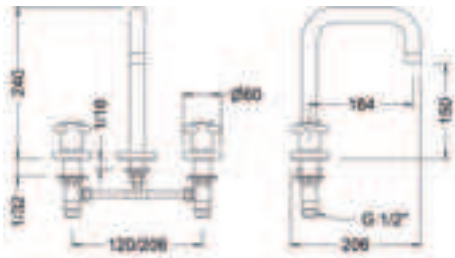

Ref.: 68120 08 45 66

Carton: 1

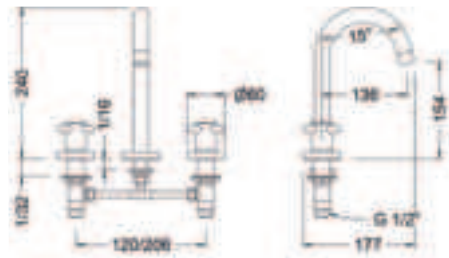

Ref.: 68124 08 45 66

Carton: 1

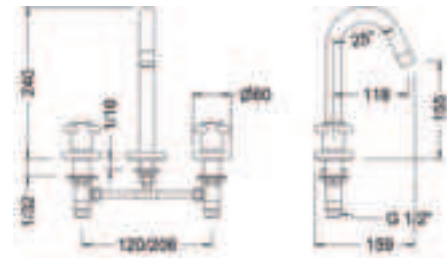
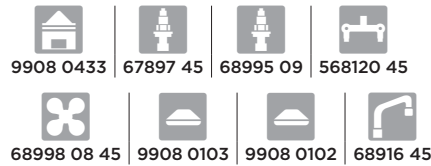

Ref.: 68125 08 45 66

Carton: 1

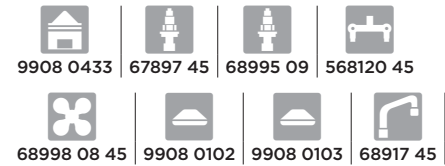

Serie Kross Acabado cromado. Montura 1/4 vuelta cierre cerámico. Chromed finish. Ceramic headwork quarter turn

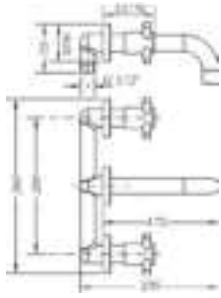

Ref.: 68131 08 45 66

Carton: 1

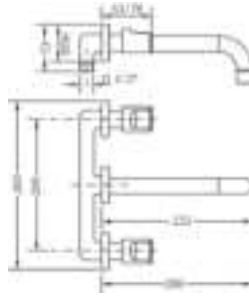

Ref.: 68132 08 45 66

Carton: 1

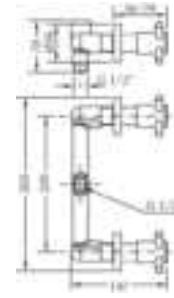

Ref.: 68115 08 45 66

Carton: 1

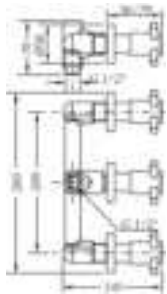
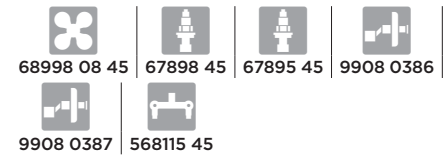

Ref.: 68116 08 45 66

Carton: 1

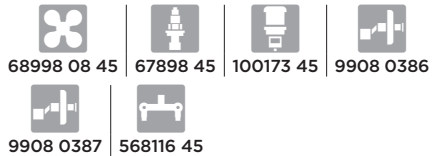

Ref.: 63114 30 45 66

Box: 1 | Carton: 8 | Pallet: 384

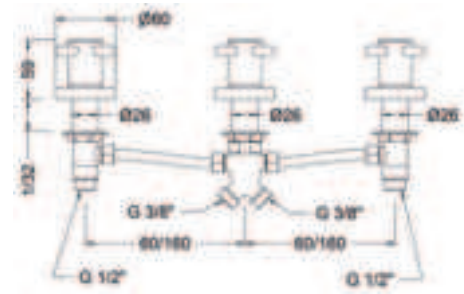

Ref.: 68113 08 45 66

Carton: 1

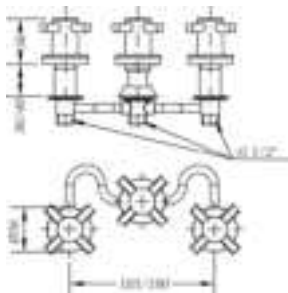

Ref.: 68142 08 45 66

Carton: 1

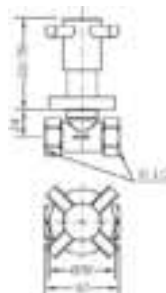
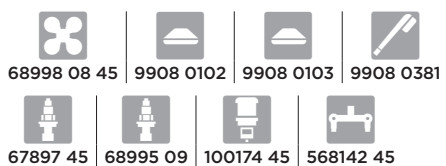

Ref.: 68170 08 45 66

Carton: 1

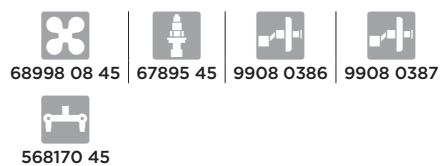

Las series Kalo, Kross e Ixo nacen de la combinación de diferentes componentes: cuerpos, caños y volantes. Busque la combinación que mejor se adapte a su baño. Puede pedirla utilizando la referencia del catálogo (conjunto) o bien por referencia de cada uno de los componentes. En este apartado podrá identificar fácilmente las referencias de cada componente necesario.

The series Kalo, Kross and Ixo are born from the combination of different components: bodies, pipes and handles. Look for the combination that best suits your bathroom. You can order it using the set reference or by components reference. In this section you can easily identify the references of each required component

Serie Ixo Acabado cromado. Montura 1/4 vuelta cierre cerámico. Chromed finish. Ceramic headwork quarter turn

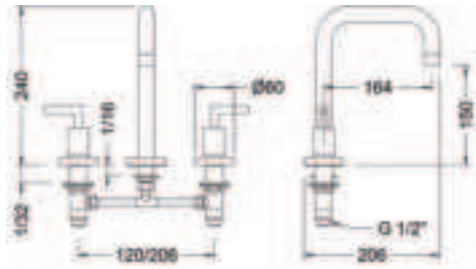

Ref.: 68120 12 45 66

Carton: 1

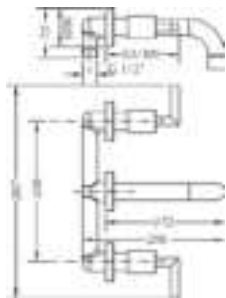
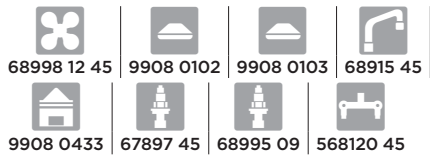

Ref.: 68131 12 45 66

Carton: 1

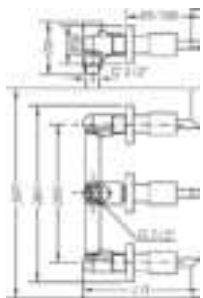
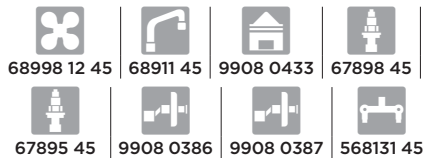

Ref.: 68116 12 45 66

Carton: 1

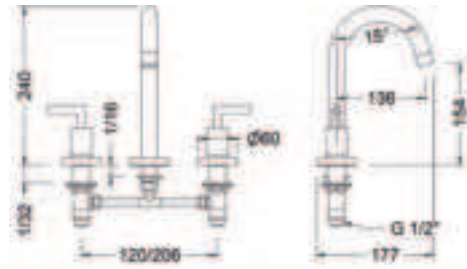
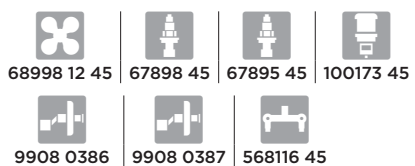

Ref.: 68124 12 45 66

Carton: 1

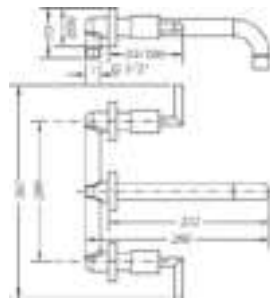
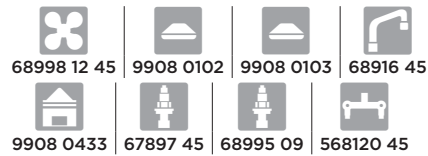

Ref.: 68132 12 45 66

Carton: 1



Ref.: 63114 30 45 66

Box: 1 | Carton: 8 | Pallet: 384

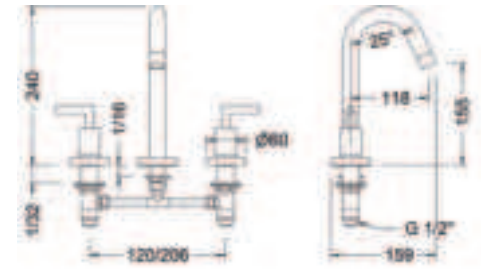

Ref.: 68125 12 45 66

Carton: 1

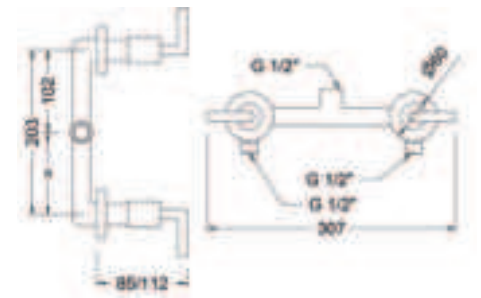
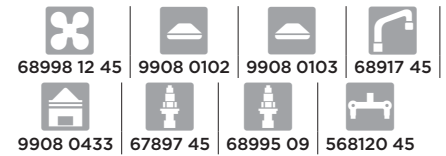

Ref.: 68115 12 45 66

Carton: 1

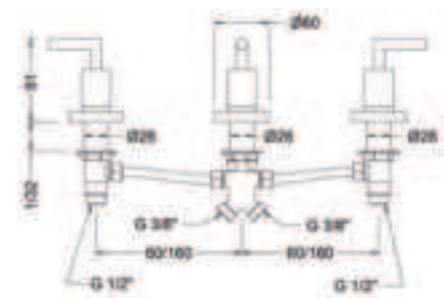
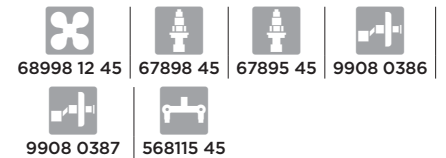

Ref.: 68113 12 45 66

Carton: 1



Serie Ixo Acabado cromado. Montura 1/4 vuelta cierre cerámico. Chromed finish. Ceramic headwork quarter turn

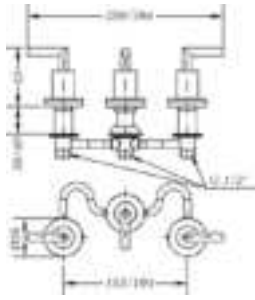

Ref.: 68142 12 45 66

Carton: 1

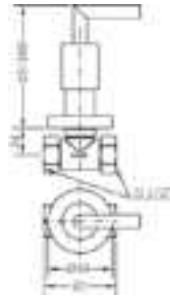
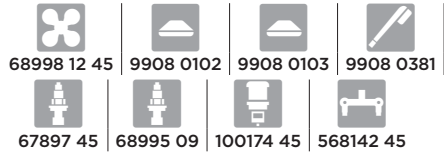

Ref.: 68170 12 45 66

Carton: 1

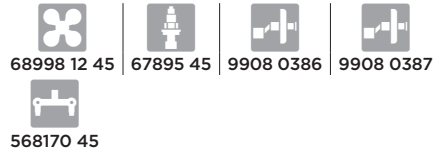

Las series Kalo, Kross e Ixo nacen de la combinación de diferentes componentes: cuerpos, caños y volantes. Busque la combinación que mejor se adapte a su baño. Puede pedirla utilizando la referencia del catálogo (conjunto) o bien por referencia de cada uno de los componentes. En este apartado podrá identificar fácilmente las referencias de cada componente necesario.

The series Kalo, Kross and Ixo are born from the combination of different components: bodies, pipes and handles. Look for the combination that best suits your bathroom. You can order it using the set reference or by components reference. In this section you can easily identify the references of each required component

Cocinas. Kitchen

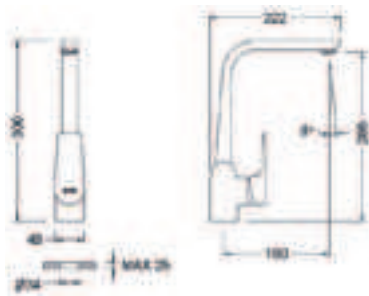

Ref.: 64201 32 45 66

Box: 1 | Carton: 8 | Pallet: 144

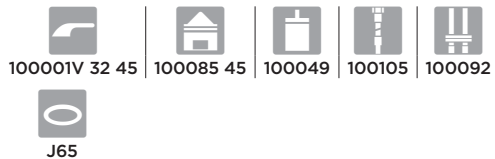

Ref.: 64201 16 45 66

Box: 1 | Carton: 8 | Pallet: 96

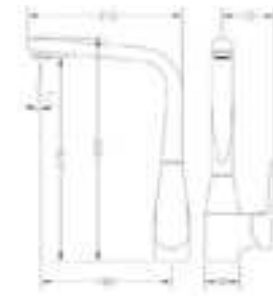
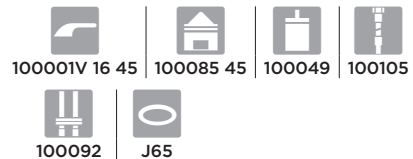

Ref.: 64201 04 45 66

Box: 1 | Carton: 8 | Pallet: 144

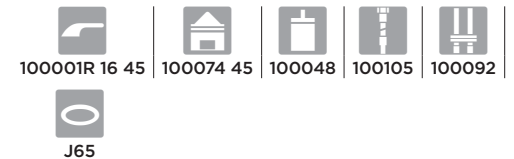

Cocinas. Kitchen

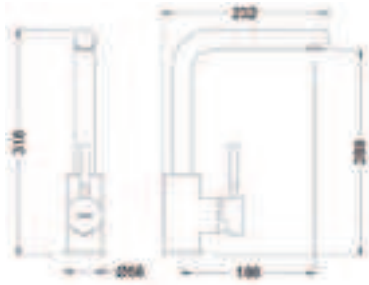

Ref.: 65214 18 45 66

Box: 1 | Carton: 5 | Pallet: 135

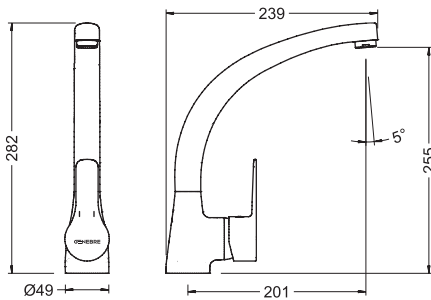
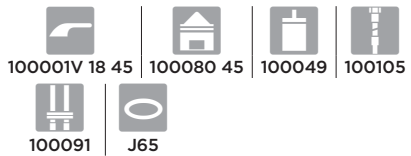

Ref.: 61201 28 45 66

Box: 1 | Carton: 10 | Pallet: 160

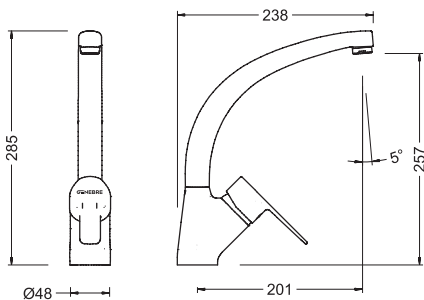
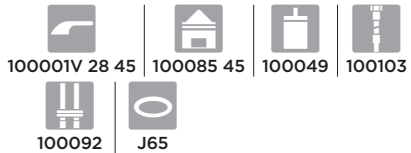

Ref.: 61210 28 45 66

Box: 1 | Carton: 8 | Pallet: 144

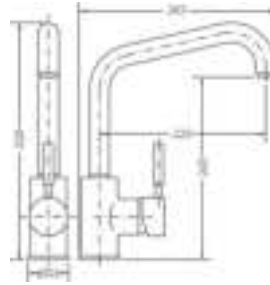
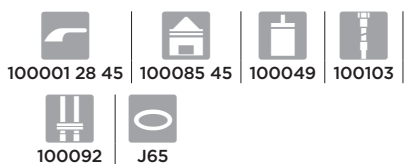

Ref.: 65204 18 45 66

Box: 1 | Carton: 5 | Pallet: 135

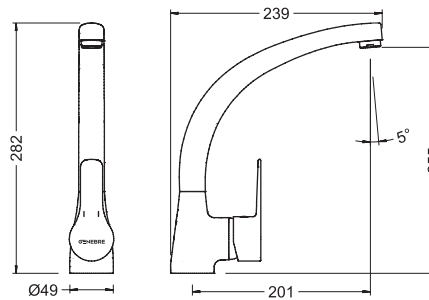
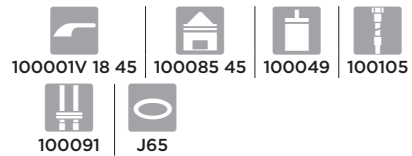

Ref.: 61203 28 45 66

Box: 1 | Carton: 8 | Pallet: 192

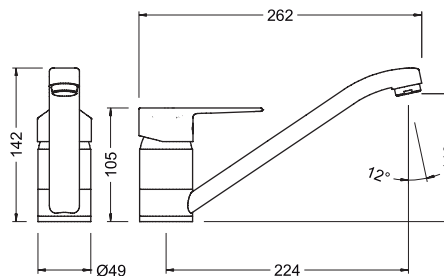
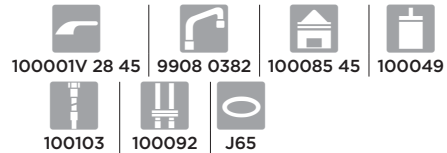

Ref.: 61200 28 45 66

Box: 1 | Carton: 9 | Pallet: 288

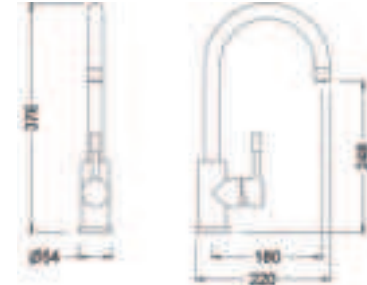
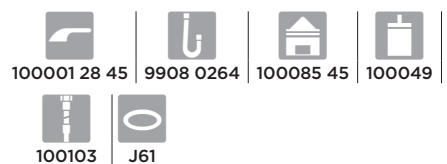

Ref.: 65203 18 60 66

Box: 1 | Carton: 5 | Pallet: 60

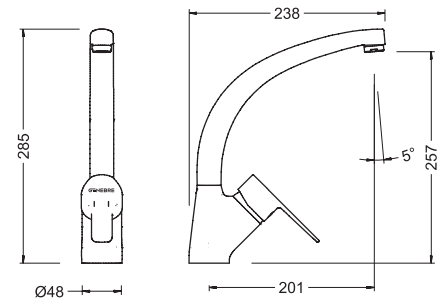

Ref.: 61204 28 45 66

Box: 1 | Carton: 8 | Pallet: 144

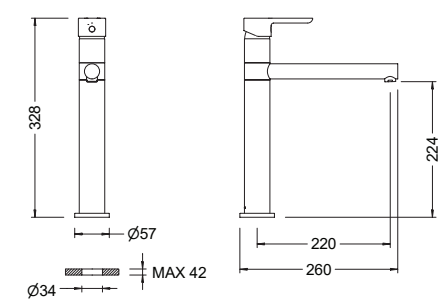

Ref.: 65200 19 45 66

Box: 1 | Carton: 10 | Pallet: 80

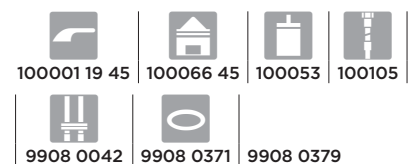

Cocinas. Kitchen

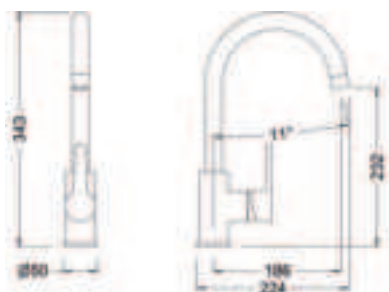

Ref.: 65203 19 45 66

Box: 1 | Carton: 8 | Pallet: 96

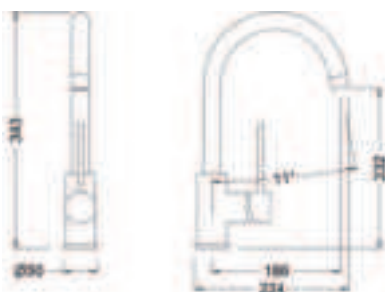

Ref.: FRT65402

Box: 1 | Carton: 8 | Pallet: 96

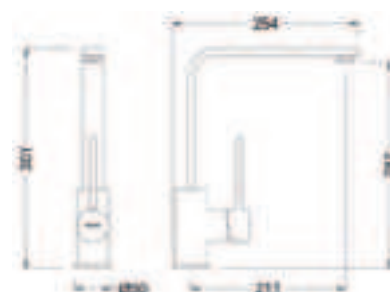

Ref.: 65404 18 45 66

Box: 1 | Carton: 8 | Pallet: 96

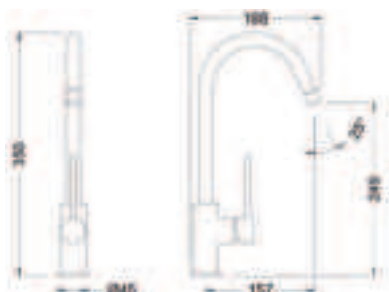
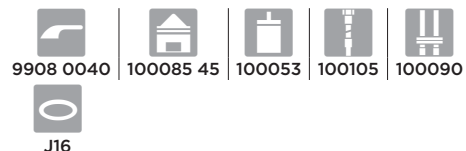

Ref.: 65403 18 45 66

Box: 1 | Carton: 8 | Pallet: 96

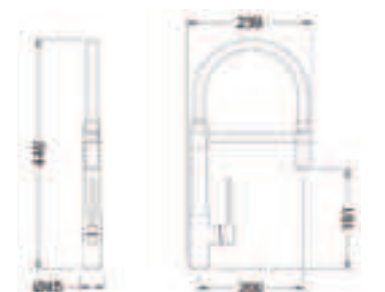
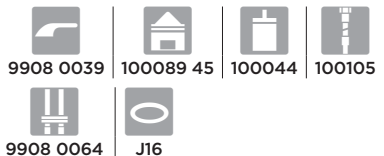

Ref.: 65219 18 45 66

Box: 1 | Carton: 4 | Pallet: 96

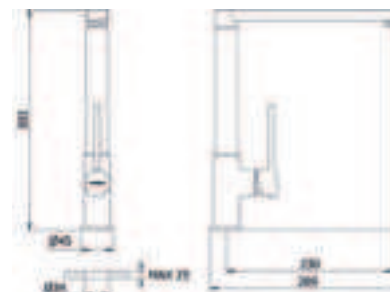
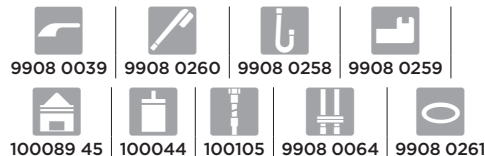

Ref.: 65215 18 45 66

Box: 1 | Carton: 8 | Pallet: 96

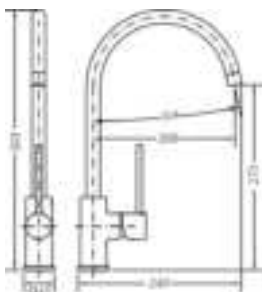
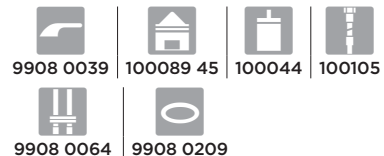

Ref.: FRT65401

Box: 1 | Carton: 8 | Pallet: 96

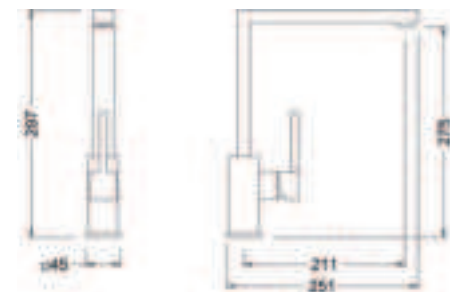
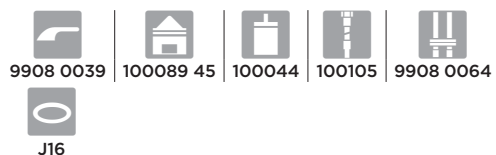

Ref.: FRK63400

Box: 1 | Carton: 8 | Pallet: 96

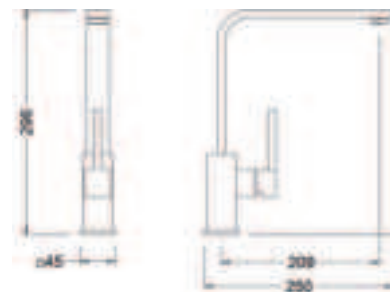
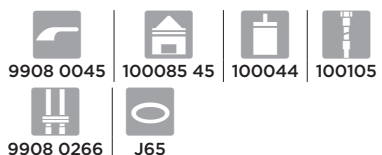

Ref.: FRK63401

Box: 1 | Carton: 8 | Pallet: 96

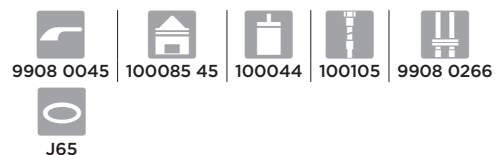

Cocinas. Kitchen

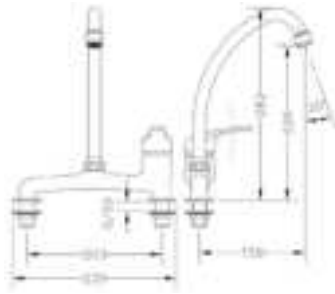

Ref.: 60198 05 45 66

Box: 1 | Carton: 6 | Pallet: 144



100001 05 45 | 100088 45 | 100053 | 100098 | J68

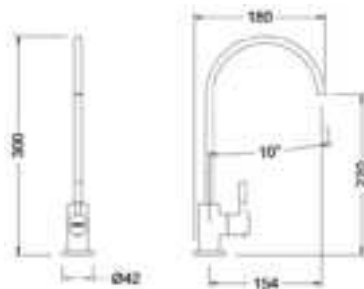

Ref.: 65700 18 45 66

| Carton: 14 | Pallet: 252



9908 0272 | 67998 45 | 9908 0271 | 9908 0263

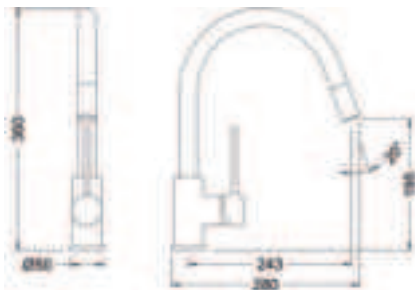

Ref.: FRV61206

Box: 1 | Carton: 4 | Pallet: 36

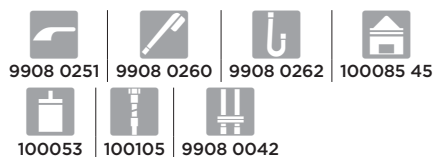

9908 0251 | 9908 0260 | 9908 0262 | 100085 45 | 100053 | 100105 | 9908 0042

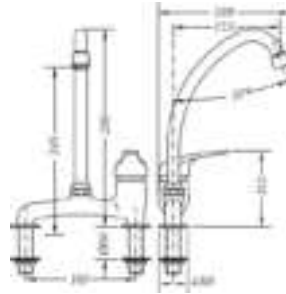

Ref.: 60199 05 45 66

Box: 1 | Carton: 12 | Pallet: 240



100001 05 45 | 100088 45 | 100053 | 100098 | J68

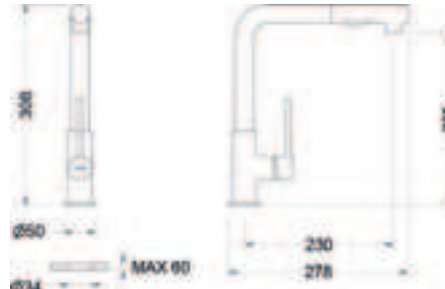

Ref.: FRV61208 44

Box: 1 | Carton: 4 | Pallet: 36

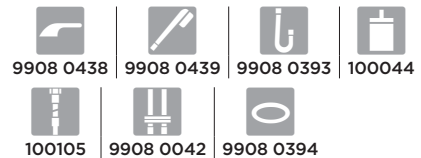

9908 0438 | 9908 0439 | 9908 0393 | 100044 | 100105 | 9908 0042 | 9908 0394

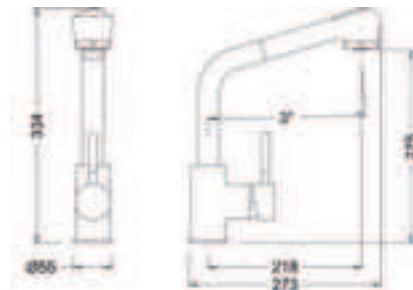

Ref.: 65205 18 45 66

Box: 1 | Carton: 6 | Pallet: 108



100001V 18 45 | 100252 45 | 100143 45 | 100085 45 | 100049 | 100105 | 100118 | 100097

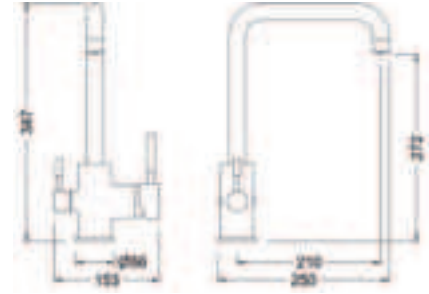

Ref.: 65702 18 45 66

Box: 1 | Carton: 4 | Pallet: 96

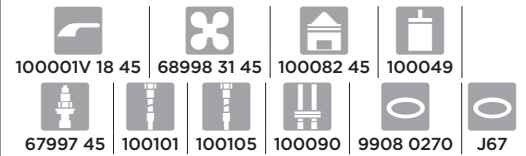

100001V 18 45 | 68998 31 45 | 100082 45 | 100049 | 67997 45 | 100101 | 100105 | 100090 | 9908 0270 | J67

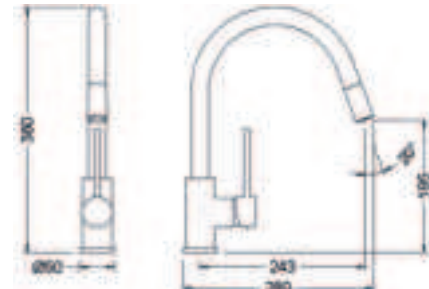

Ref.: FRV61207 44

Box: 1 | Carton: 4 | Pallet: 36

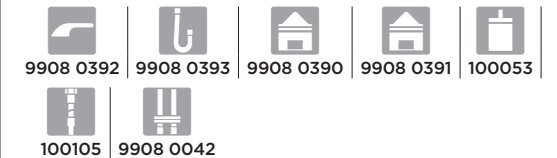

9908 0392 | 9908 0393 | 9908 0390 | 9908 0391 | 100053 | 100105 | 9908 0042

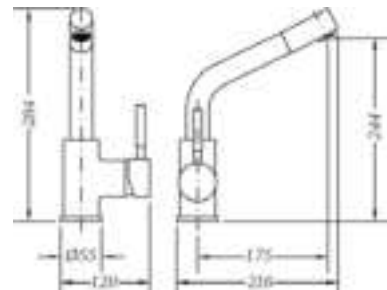

Ref.: 65206 18 45 66

Box: 1 | Carton: 8 | Pallet: 192

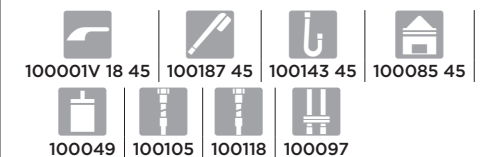

100001V 18 45 | 100187 45 | 100143 45 | 100085 45 | 100049 | 100105 | 100118 | 100097

Cocinas. Kitchen

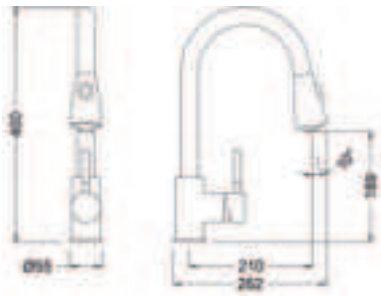

Ref.: FRV61205

Box: 1 | Carton: 4 | Pallet: 72

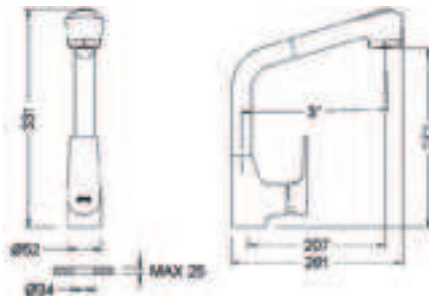
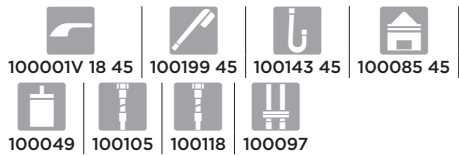

Ref.: 64206 32 45 66

Box: 1 | Carton: 6 | Pallet: 108

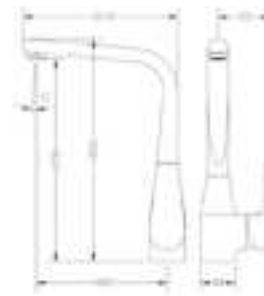
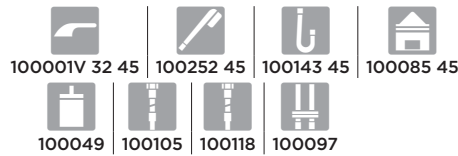

Ref.: 64201 16 45 66

Box: 1 | Carton: 8 | Pallet: 96

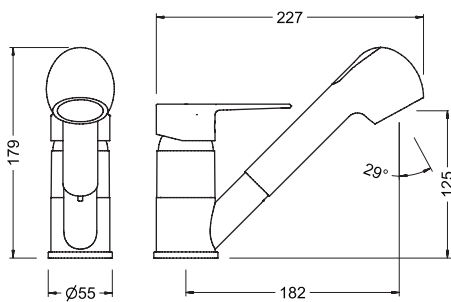
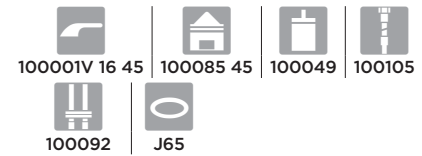

Ref.: 61205 28 45 66

Box: 1 | Carton: 10 | Pallet: 180

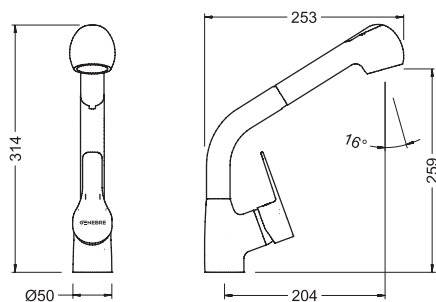
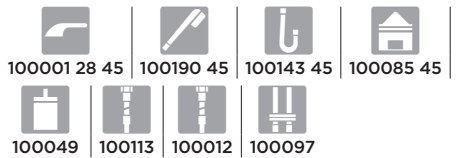

Ref.: 61206 28 45 66

Box: 1 | Carton: 10 | Pallet: 180

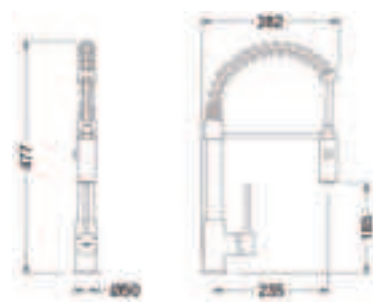
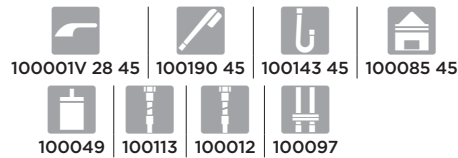

Ref.: 65211 18 45 66

Box: 1 | Carton: 4 | Pallet: 36

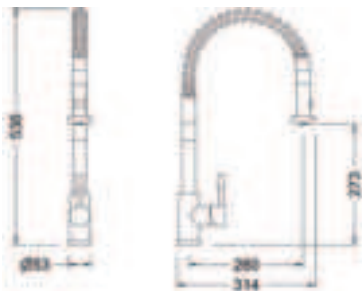
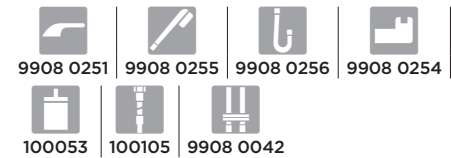

Ref.: 65207 18 60 66

Box: 1 | Carton: 4 | Pallet: 36

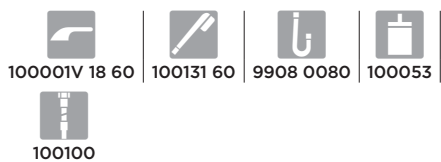

Cocinas. Kitchen

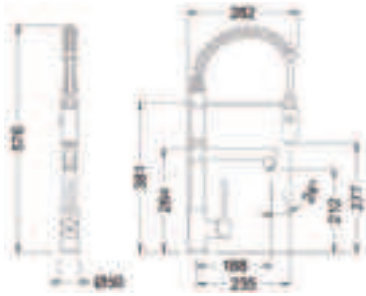

Ref.: 65212 18 45 66

Box: 1 | Carton: 4 | Pallet: 36

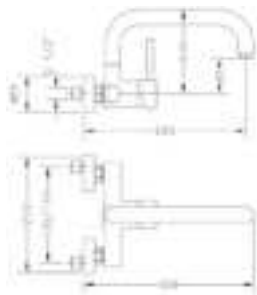

Ref.: 65192 18 45 66

Box: 1 | Carton: 4 | Pallet: 72

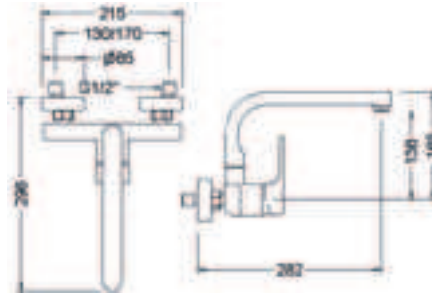

Ref.: 64192 32 45 66

Box: 1 | Carton: 6 | Pallet: 72



Ref.: 65192 19 45 66

Box: 1 | Carton: 6 | Pallet: 54

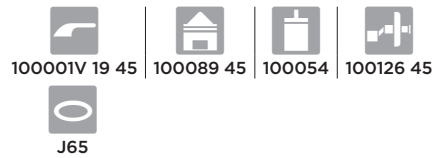

Ref.: 64192 16 45 66

Box: 1 | Carton: 6 | Pallet: 72

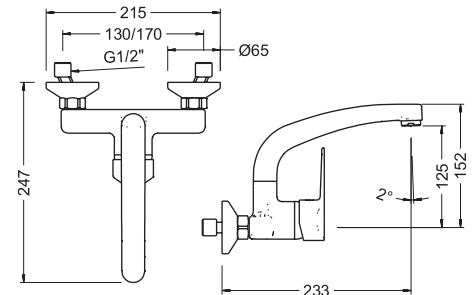
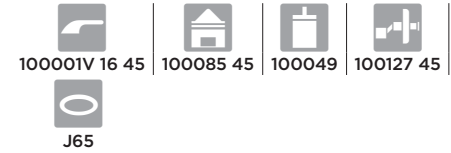

Ref.: 61190 28 45 66

Box: 1 | Carton: 10 | Pallet: 120



Cocinas. Kitchen

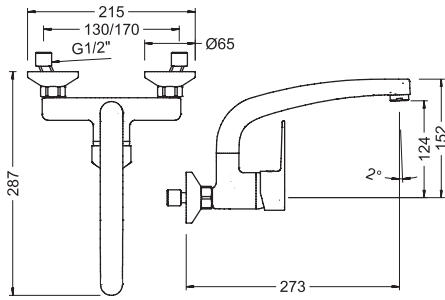

Ref.: 61192 28 45 66

Box: 1 | Carton: 4 | Pallet: 96

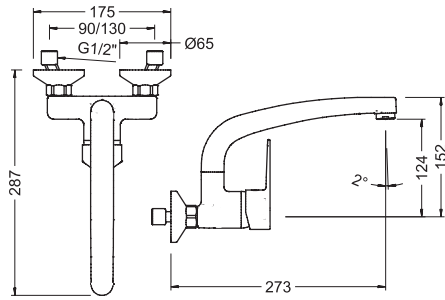

Ref.: 61195 28 45 66

Box: 1 | Carton: 6 | Pallet: 144

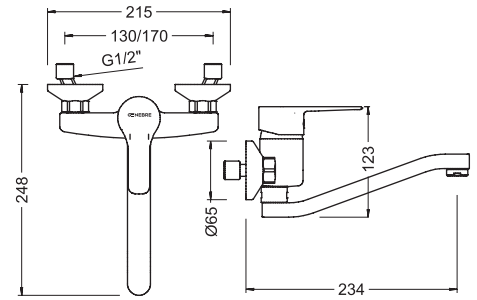

Ref.: 61196 28 45 66

Box: 1 | Carton: 8 | Pallet: 192

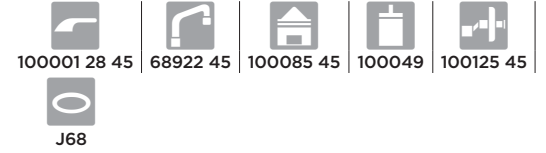

Ref.: 60194 05 45 66

Box: 1 | Carton: 8 | Pallet: 192

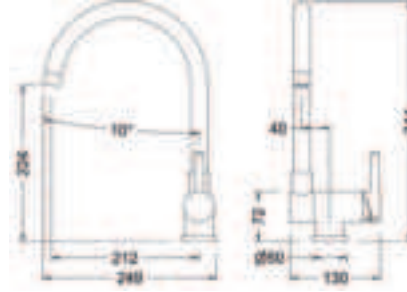

Ref.: 65900 18 45 66

Box: 1 | Carton: 8 | Pallet: 96

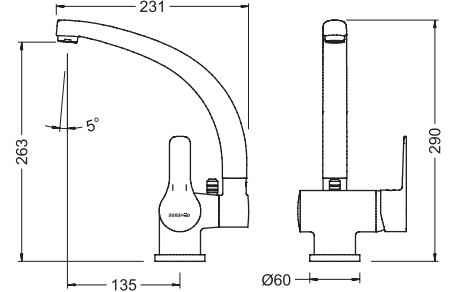
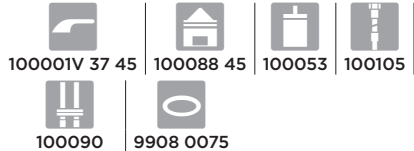

Ref.: 61900 28 45 66

Box: 1 | Carton: 6 | Pallet: 108

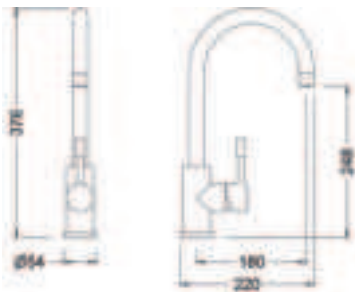
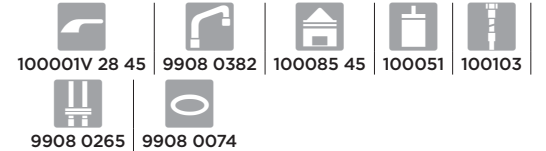

Ref.: 65203 18 60 66

Box: 1 | Carton: 5 | Pallet: 60

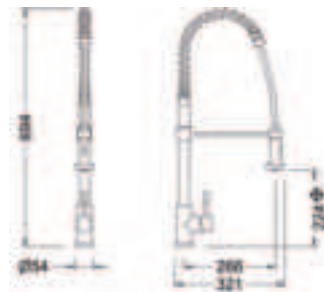

Ref.: 65211 18 60 66

Box: 1 | Carton: 4 | Pallet: 36

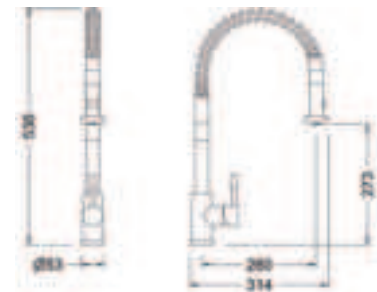
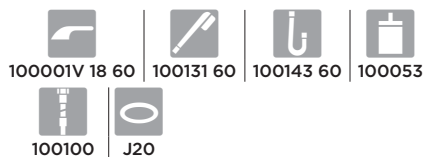

Ref.: 65207 18 60 66

Box: 1 | Carton: 4 | Pallet: 36



Cocinas. Kitchen

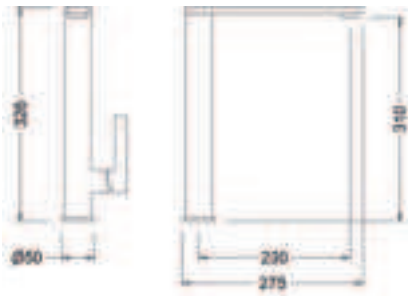

Ref.: 65215 40 60 66

Box: 1 | Carton: 4 | Pallet: 48

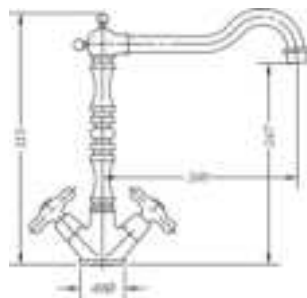

Ref.: 68595 09 45 66

Box: 1 | Carton: 4 | Pallet: 96

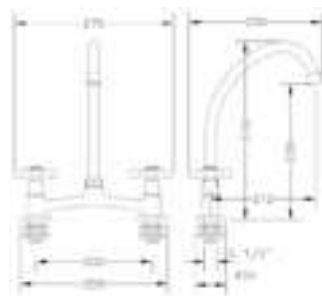

Ref.: 68545 09 45 66

Box: 1 | Carton: 10 | Pallet: 240

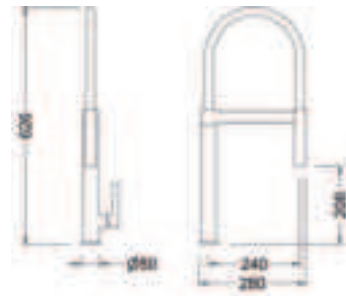

Ref.: 65219 40 60 66

Box: 1 | Carton: 4 | Pallet: 36

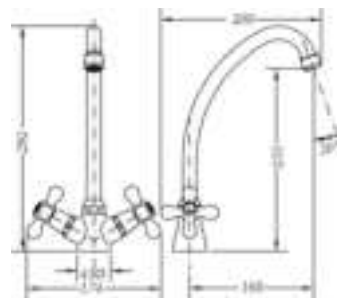

Ref.: 68540 09 45 66

Box: 1 | Carton: 10 | Pallet: 240

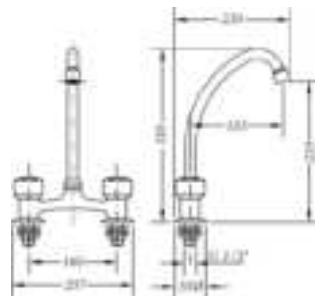

Ref.: 68194 11 45 66

Box: 1 | Carton: 10 | Pallet: 240

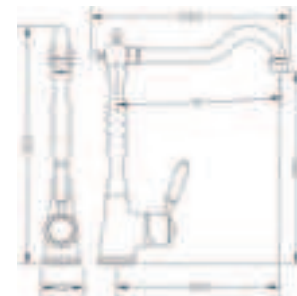

Ref.: 68201 39 43 66

Box: 1 | Carton: 4 | Pallet: 96

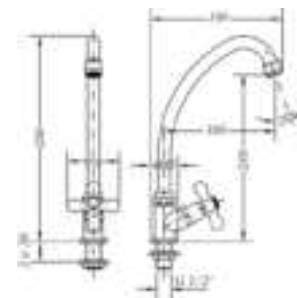

Ref.: 68585 09 45 66

Box: 1 | Carton: 10 | Pallet: 240

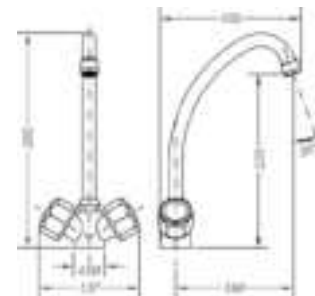

Ref.: 68200 11 45 66

Box: 1 | Carton: 10 | Pallet: 240

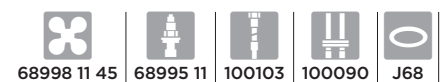

Cocinas. Kitchen

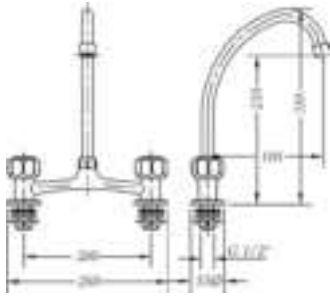

Ref.: 68199 11 45 66

Box: 1 | Carton: 10 | Pallet: 240



9908 0063

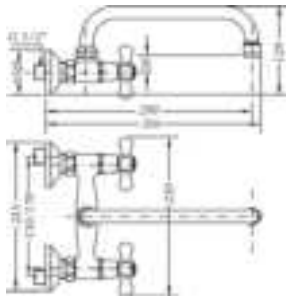

Ref.: 68555 09 45 66

Box: 1 | Carton: 10 | Pallet: 240



100125 45

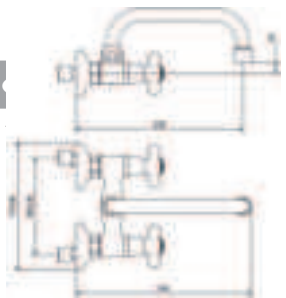

Ref.: 68550 09 45 66

Box: 1 | Carton: 10 | Pallet: 240



100125 45

J68

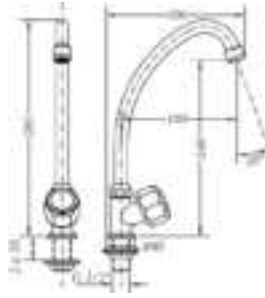

Ref.: 68003 11 45 66

Box: 1 | Carton: 10 | Pallet: 240



9908 0063

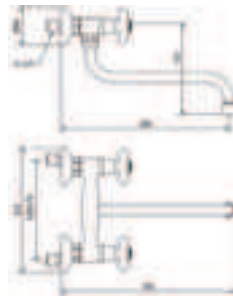

Ref.: 68560 09 45 66

Box: 1 | Carton: 10 | Pallet: 240



100125 45

J68

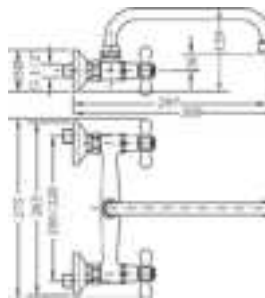

Ref.: 68565 09 45 66

Box: 1 | Carton: 10 | Pallet: 240



100125 45

J68

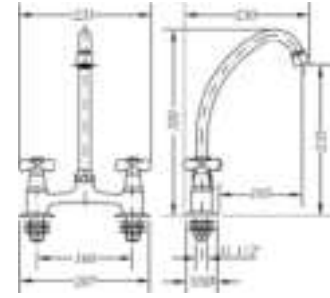

Ref.: 68194 09 45 66

Box: 1 | Carton: 10 | Pallet: 240



68998 09 45 | 100088 45 | 68995 09 | 100098 | J68

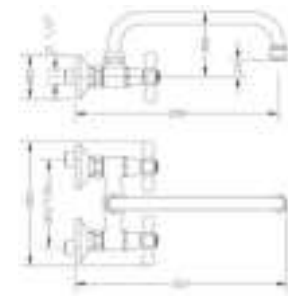

Ref.: 68196 09 45 66

Carton: 1



100125 45

J68

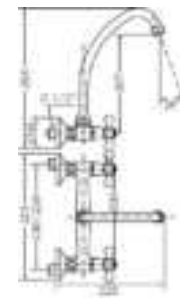

Ref.: 68570 09 45 66

Box: 1 | Carton: 10 | Pallet: 240



68998 09 45 | 100088 45 | 68995 09 | 100125 45 | J68

Cocinas. Kitchen

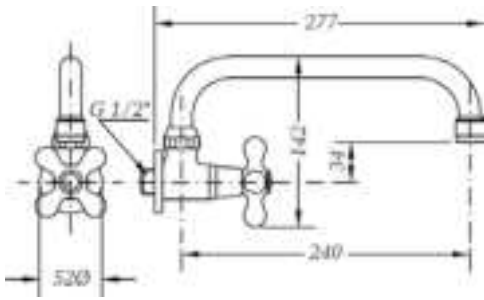

Ref.: 68580 09 45 66

Box: 1 | Carton: 10 | Pallet: 240

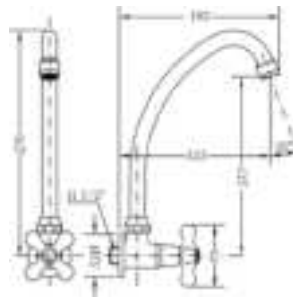

Ref.: 68575 09 45 66

Box: 1 | Carton: 10 | Pallet: 240

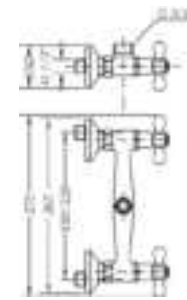

Ref.: 568565 45

Box: 1 | Carton: 15 | Pallet: 270

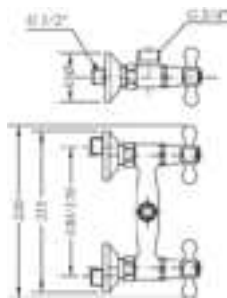

Ref.: 568555 45

Box: 1 | Carton: 15 | Pallet: 270

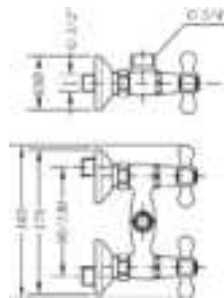

Ref.: 568550 45

Box: 1 | Carton: 15 | Pallet: 270

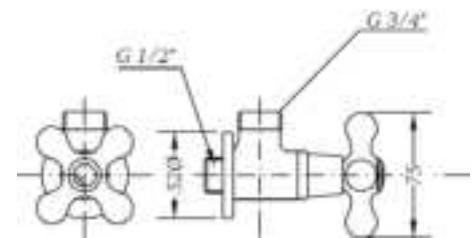

Ref.: 568575 45

Box: 1 | Carton: 15 | Pallet: 270

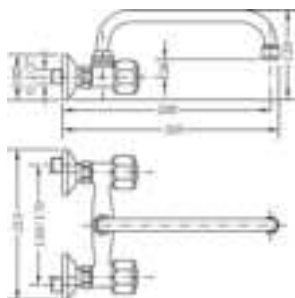

Ref.: 68193 11 45 66

Box: 1 | Carton: 10 | Pallet: 240

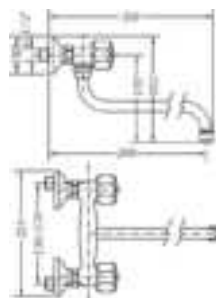
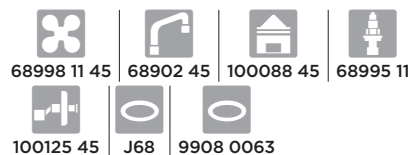

Ref.: 68197 11 45 66

Box: 1 | Carton: 10 | Pallet: 240

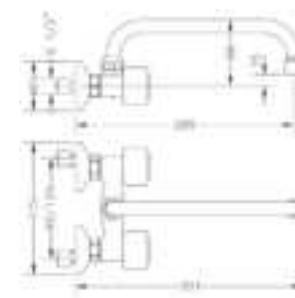
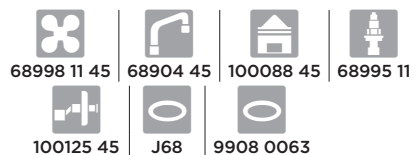

Ref.: 68196 11 45 66

Box: 1 | Carton: 10 | Pallet: 270

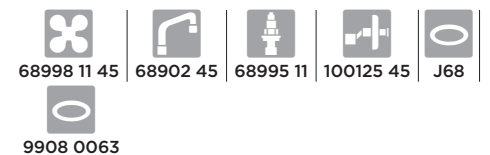

Cocinas. Kitchen

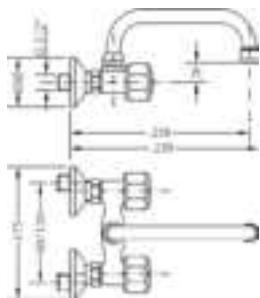

Ref.: 68195 11 45 66

Box: 1 | Carton: 17 | Pallet: 204

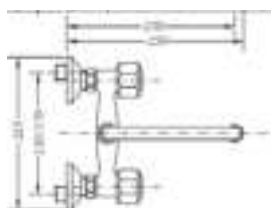

Ref.: 68190 11 45 66

Box: 1 | Carton: 17 | Pallet: 204

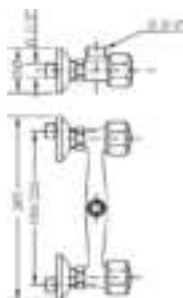
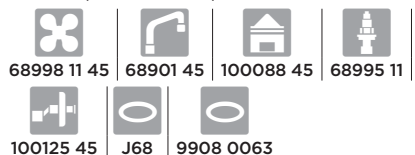

Ref.: 568104 45

Box: 1 | Carton: 15 | Pallet: 240

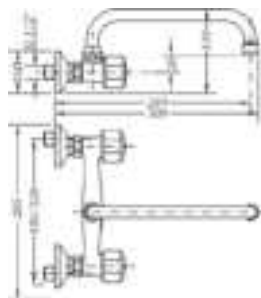

Ref.: 68104 11 45 66

Box: 1 | Carton: 10 | Pallet: 240

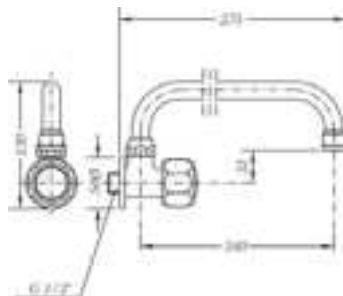

Ref.: 68093 11 45 66

Box: 1 | Carton: 10 | Pallet: 240

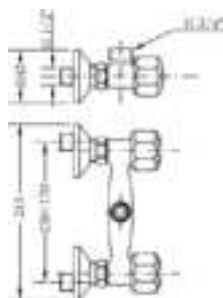
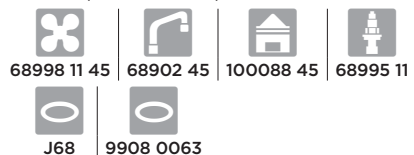

Ref.: 568193 45

Box: 1 | Carton: 20 | Pallet: 360

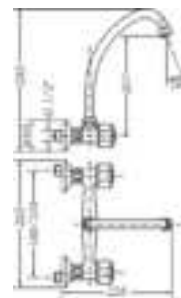

Ref.: 68103 11 45 66

Box: 1 | Carton: 10 | Pallet: 240

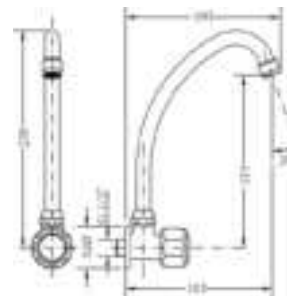
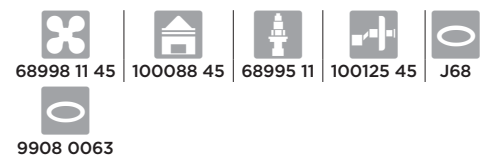

Ref.: 68083 11 45 66

Box: 1 | Carton: 19 | Pallet: 228

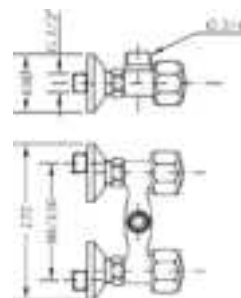
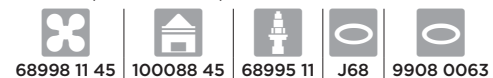

Ref.: 568195 45

Box: 1 | Carton: 20 | Pallet: 360

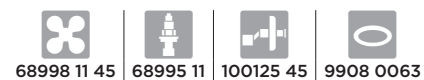

Cocinas. Kitchen

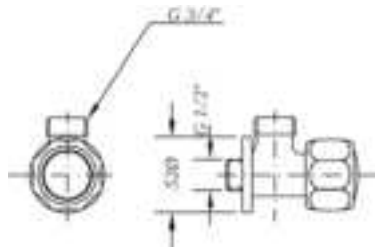

Ref.: 568083 45

Box: 1 | Carton: 40 | Pallet: 960

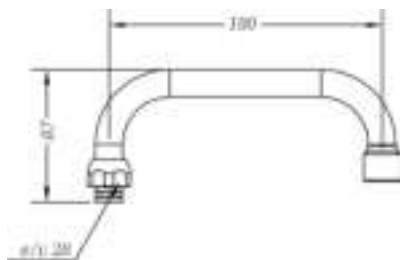

Ref.: 68901 45

Box: 1 | Carton: 40 | Pallet: 720

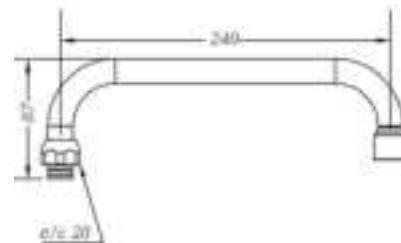

Ref.: 68902 45

Box: 1 | Carton: 30 | Pallet: 540

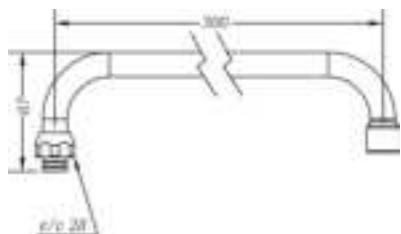

Ref.: 68908 45

Box: 1 | Carton: 40 | Pallet: 720

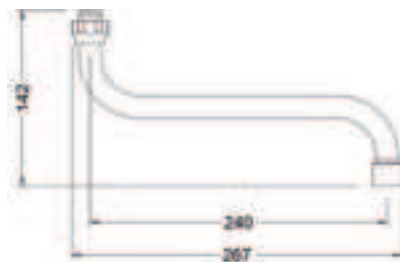

Ref.: 68904 45

Box: 1 | Carton: 30 | Pallet: 540

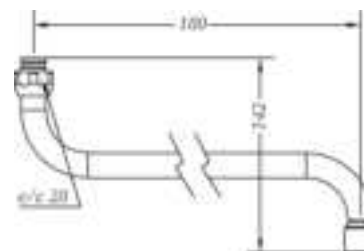

Ref.: 68910 45

Box: 1 | Carton: 40 | Pallet: 720

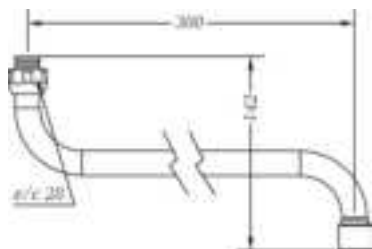

Ref.: 68909 45

Box: 1 | Carton: 40 | Pallet: 480

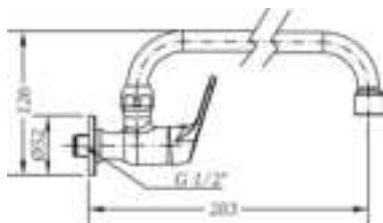

Ref.: 1008 04

Box: 1 | Carton: 42 | Pallet: 504

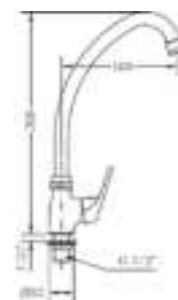

Ref.: 1009 04

Box: 1 | Carton: 30 | Pallet: 540



Cocinas. Kitchen



Ref.: 1005 04

Box: 1 | Carton: 42 | Pallet: 504



100001V 33 45 | 100088 45 | 100042 | J68

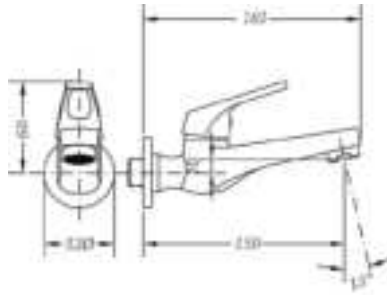

Ref.: 1003 04

Box: 1 | Carton: 48 | Pallet: 864



100001 33 45 | 100085 45 | 100042

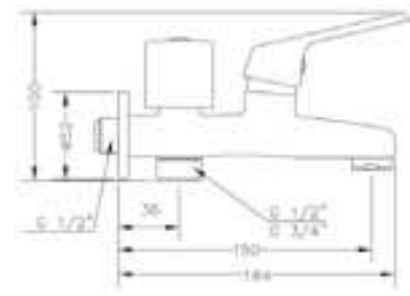

Ref.: 1024 04

Box: 1 | Carton: 22 | Pallet: 704



100001 33 45 | 68998 28 45 | 100085 45 | 100042



68995 09

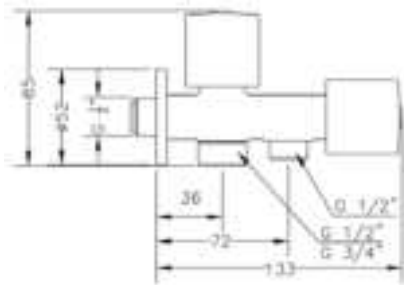

Ref.: 1023 04

Box: 1 | Carton: 48 | Pallet: 864



68998 28 45 | 68995 09

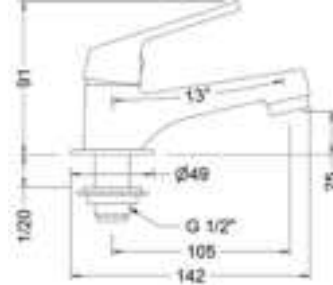

Ref.: 1002 04

Box: 1 | Carton: 42 | Pallet: 840



100001 33 45 | 100085 45 | 100042 | 100098



Ref.: 1007 04

Box: 1 | Carton: 22 | Pallet: 704



100085 45 | 100042 | 100098

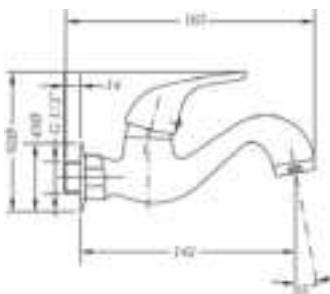

Ref.: 1006 04

Box: 1 | Carton: 36 | Pallet: 864



100085 45 | 100042

Accesorios. Accessories

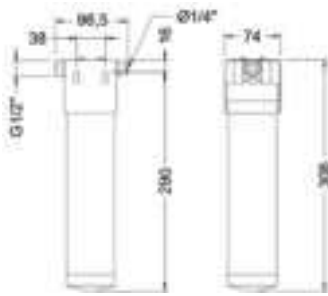

Ref.: FT00

Box: 1 | Carton: 16 | Pallet: 160

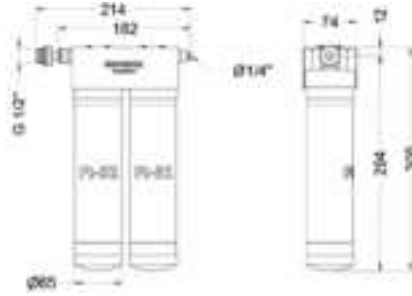

Ref.: FT01

Box: 1 | Carton: 8 | Pallet: 100



Ref.: DXK3 45

Box: 1 | Carton: 36 | Pallet: 324

FT92



FT91 | FT92



Ref.: 9908 0284

Box: 1 | Carton: 25 | Pallet: 225



Ref.: DXT5 45

Box: 1 | Carton: 24 | Pallet: 288

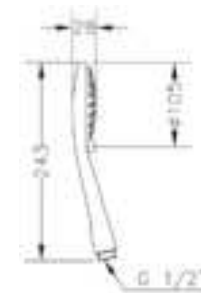

Ref.: DXT3 45

Box: 1 | Carton: 36 | Pallet: 324

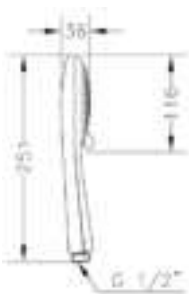

Ref.: DXO3 45

Box: 1 | Carton: 36 | Pallet: 324

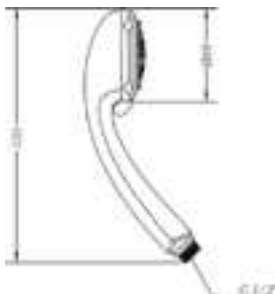

Ref.: DXE5 45

Box: 1 | Carton: 45 | Pallet: 405

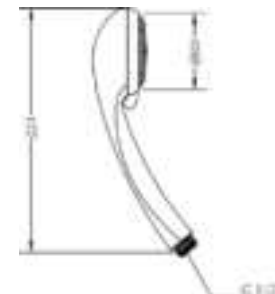

Ref.: DXE2 45

Box: 1 | Carton: 45 | Pallet: 540

Accesorios. Accessories



Ref.: DXK1 45

Box: 1 | Carton: 36 | Pallet: 432

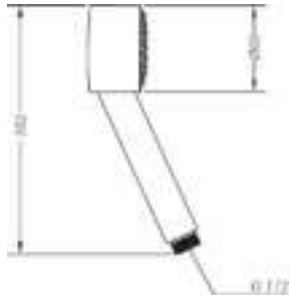

Ref.: 100197 45 00

| Carton: 100 Pallet: 1600

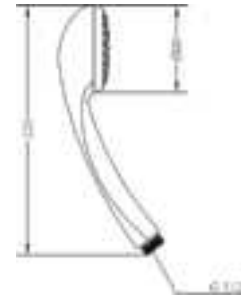

Ref.: 100175 45 00

| Carton: 40 Pallet: 1280



Ref.: 100698 45

Box: 1 | Carton: 18 | Pallet: 216

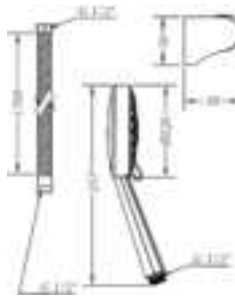

Ref.: 100699 45

Box: 1 | Carton: 18 | Pallet: 216

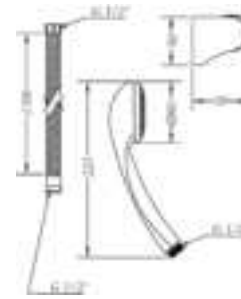

Ref.: 100697 45

Box: 1 | Carton: 18 | Pallet: 216



Ref.: 1748 45

Box: 1 | Carton: 10 | Pallet: 60



Ref.: 1747 45

Box: 1 | Carton: 10 | Pallet: 60

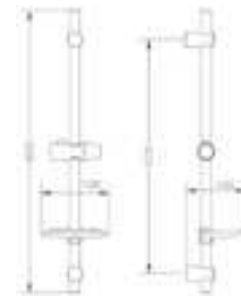

Ref.: 1636 45

Box: 1 | Carton: 10 | Pallet: 80



Ref.: 1637 45



Ref.: 1638 45



Ref.: 1639 45

Accesorios. Accessories

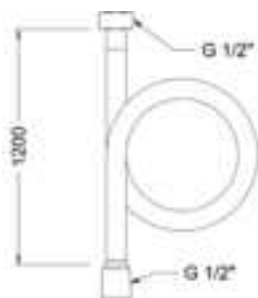

Ref.: 100141 45

| Carton: 50 | Pallet: 900

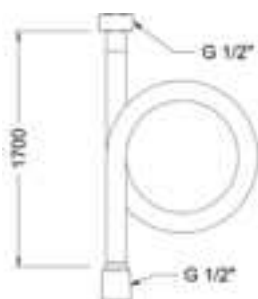

Ref.: 100140 30

Box: 1 | Carton: 24 | Pallet: 432



Ref.: 100149 45

| Carton: 60 | Pallet: 1080



Ref.: 1633 04

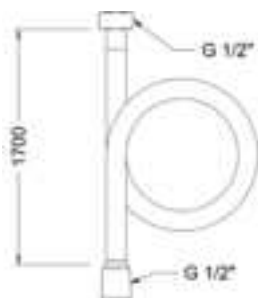

Ref.: 100135 60 00

| Carton: 35 | Pallet: 1120

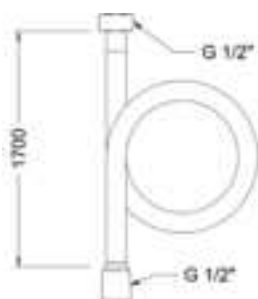

Ref.: 9908 0287

| Carton: 35 Pallet: 1120

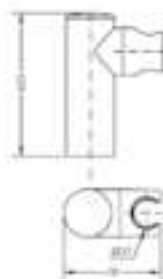

Ref.: 100153 45

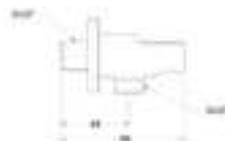

Ref.: 1634 04



Ref.: 100137 60 00

| Carton: 35 | Pallet: 1120



Ref.: 100152 45 00

| Carton: 150 | Pallet: 2700



Ref.: 100068 45



| Carton: 150 | Pallet: 1800

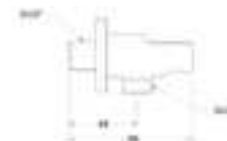

Ref.: 1946 41

Accesorios. Accessories



Ref.: 1635 04
Box: 1 | Carton: 50 | Pallet: 1600



Ref.: 1680 04
Box: 1 | Carton: 60 | Pallet: 1920



Ref.: 1649 04
Box: 1 | Carton: 50 | Pallet: 1600



Ref.: 1679 04
Box: 1 | Carton: 40 | Pallet: 1600

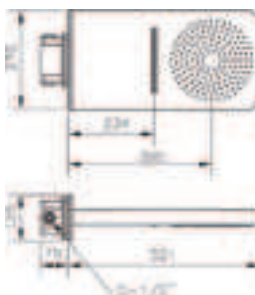

Ref.: 1643 45
Box: 1 | Carton: 2 | Pallet: 12



Ref.: R63112 08
Box: 1 | Carton: 24 | Pallet: 192



Ref.: R63112 26
Box: 1 | Carton: 24 | Pallet: 144



Ref.: R65112 18
Box: 1 | Carton: 24 | Pallet: 144



Ref.: R65112 41
Box: 1 | Carton: 12 | Pallet: 192

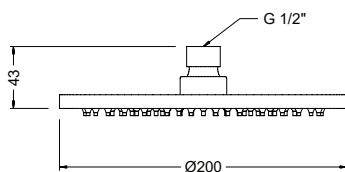

Ref.: R68113 43

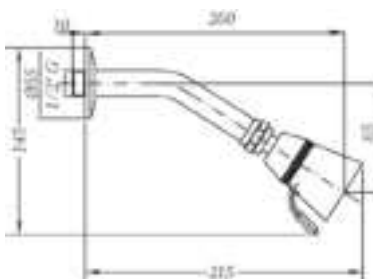

Ref.: 1698 45 00

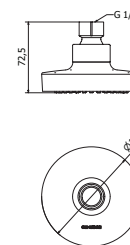

Ref.: 1155 04

Accesorios. Accessories

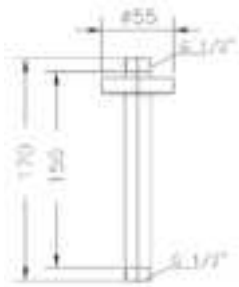

Ref.: 1671 45
 Box: 1 | Carton: 20 | Pallet: 960

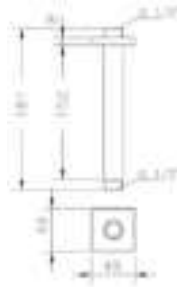

Ref.: 1672 45
 Box: 1 | Carton: 54 | Pallet: 1728

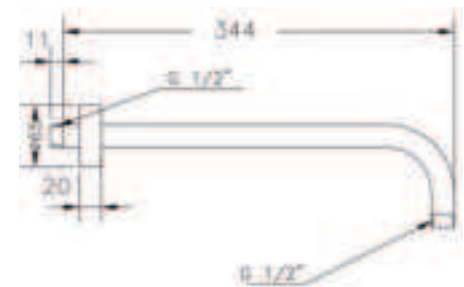

Ref.: B65113 18
 Box: 1 | Carton: 20 | Pallet: 480



Ref.: B64113 41
 Box: 1 | Carton: 20 | Pallet: 600



Ref.: B64113 43
 Box: 1 | Carton: 20 | Pallet: 600

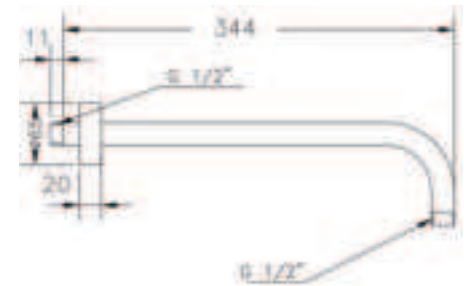

Ref.: B65114 18
 Box: 1 | Carton: 42 | Pallet: 1260

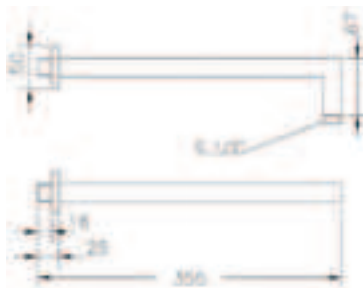

Ref.: B63113 26
 Box: 1 | Carton: 20 | Pallet: 360



Ref.: 3104 04
 Box: 2 | Carton: 132 | Pallet: 4224

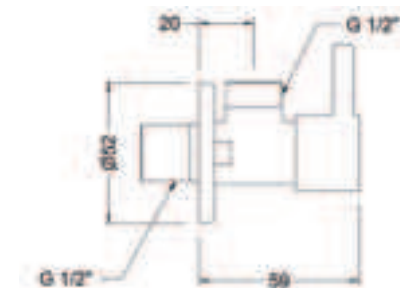

Ref.: 3110 04 41
 Box: 1 | Carton: 40 | Pallet: 960



Ref.: 3110 03 41

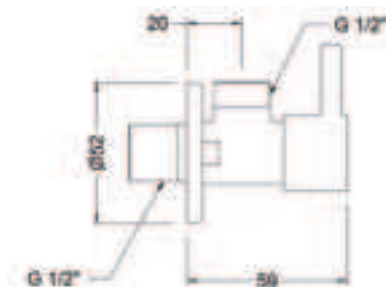

Ref.: 3104 05



Ref.: 3106 04

Accesorios. Accessories

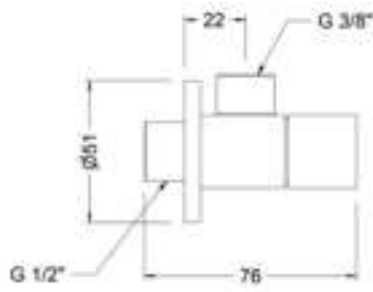

Ref.: 3106 05
Box: 2 | Carton: 120 | Pallet: 4320



Ref.: 3107 03
Carton: 1

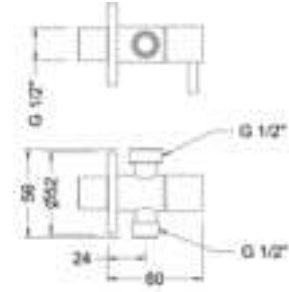

Ref.: 3107 04
Box: 1 | Carton: 160



Ref.: 3108 03
Box: 1 | Carton: 160



Ref.: 3108 04
Box: 1 | Carton: 160

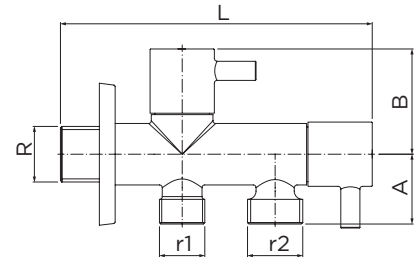

Ref.: 3109 04
Box: 1 | Carton: 90 | Pallet: 2160

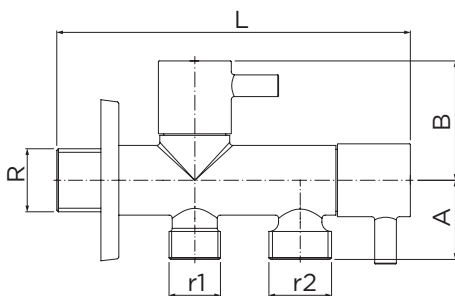

Ref.: 3109 05
Box: 1 | Carton: 60 | Pallet: 2160

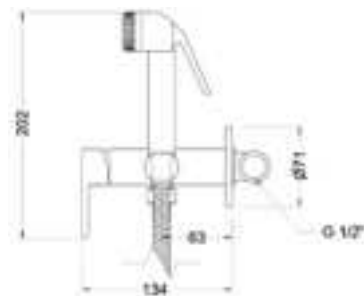

Ref.: 65144 19 45 66
Box: 1 | Carton: 18 | Pallet: 288

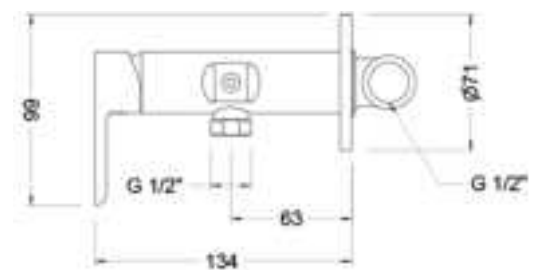

Ref.: 65144 19 45 67
Box: 1 | Carton: 20 | Pallet: 640



Accesorios. Accessories

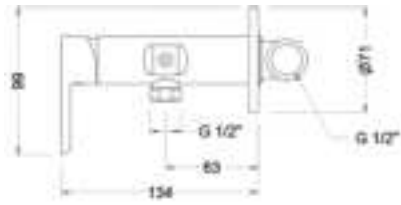

Ref.: 65144 19 41 67

Box: 1 | Carton: 20 | Pallet: 640

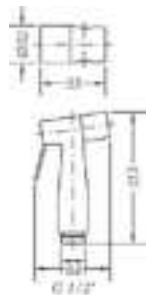

Ref.: 100694 41

Box: 1 | Carton: 22 | Pallet: 264



Ref.: 100694 45

Box: 1 | Carton: 22 | Pallet: 264



Ref.: 100696 45

Box: 1 | Carton: 100 | Pallet: 1800



Ref.: 100694 60

Box: 1 | Carton: 22 | Pallet: 264

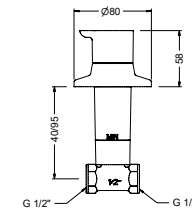

Ref.: 60170 41 45 66

Box: 1 | Carton: 8 | Pallet: 192



Ref.: 60171 41 45 66

Box: 1 | Carton: 8 | Pallet: 192

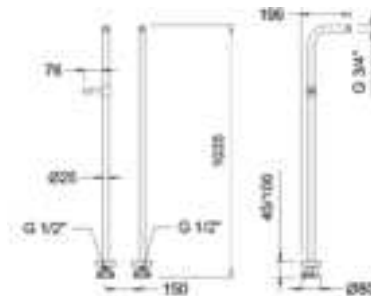

Ref.: 65120 45

Box: 1 | Carton: 2 | Pallet: 24

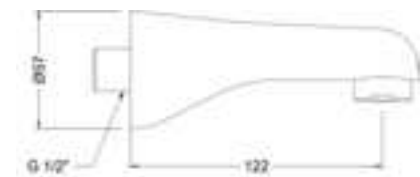

Ref.: 1667 45

Box: 1 | Carton: 60 | Pallet: 1080

Accesorios. Accessories

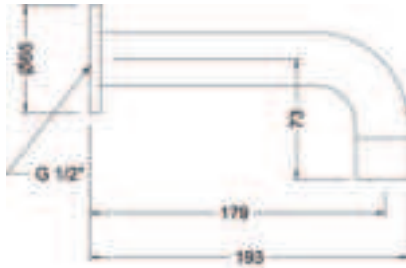

Ref.: 1668 45
Box: 1 | Carton: 20 | Pallet: 600

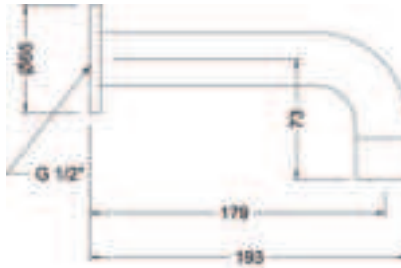

Ref.: 1668 41
Box: 1 | Carton: 21 | Pallet: 360



Ref.: 1674 45
Box: 1 | Carton: 24 | Pallet: 720

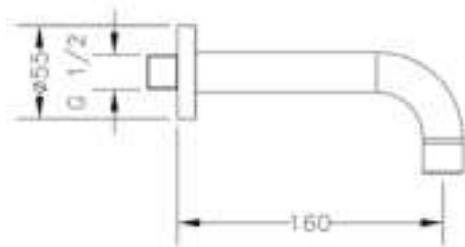

Ref.: 68911 45
Box: 1 | Carton: 40 | Pallet: 640



9908 0433

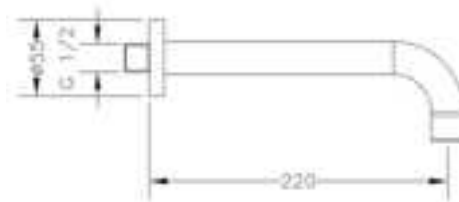

Ref.: 68912 45
Box: 1 | Carton: 40 | Pallet: 640



9908 0433

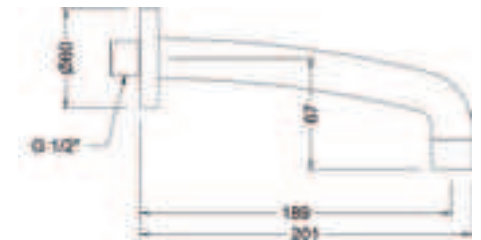

Ref.: 68913 45
Box: 1 | Carton: 24 | Pallet: 768



9908 0433

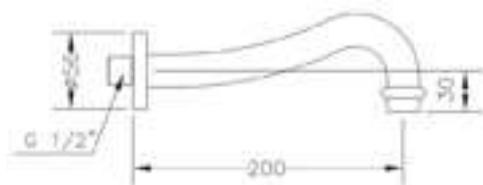

Ref.: 68914 45
Box: 1 | Carton: 24 | Pallet: 768

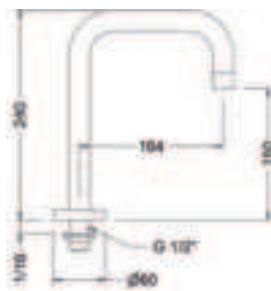

Ref.: 68915 45
Box: 1 | Carton: 30 | Pallet: 360



9908 0433 | 100098

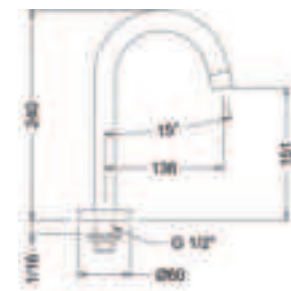

Ref.: 68916 45
Box: 1 | Carton: 30 | Pallet: 360



9908 0433 | 100098

Accesorios. Accessories

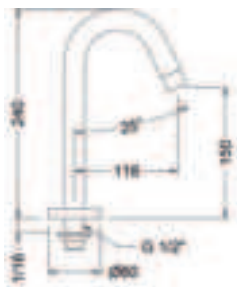

Ref.: 68917 45
 Box: 1 | Carton: 30 | Pallet: 360

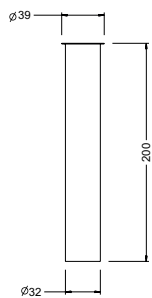

Ref.: 1632 41

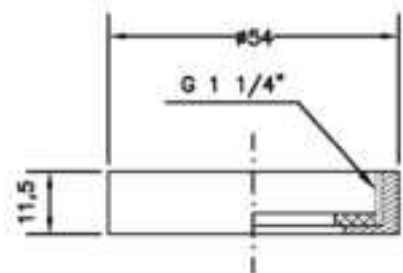

Ref.: 100134 07
 Box: 30 | Carton: 240 | Pallet: 8640

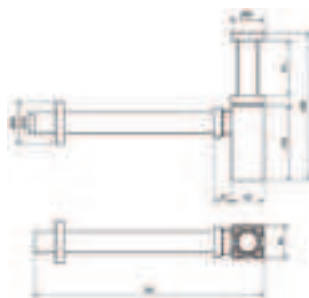

Ref.: 1621 07
 Box: 1 | Carton: 12 | Pallet: 216

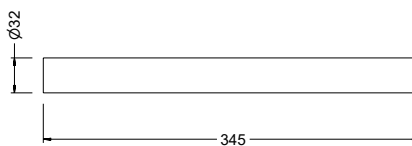

Ref.: 1640 41

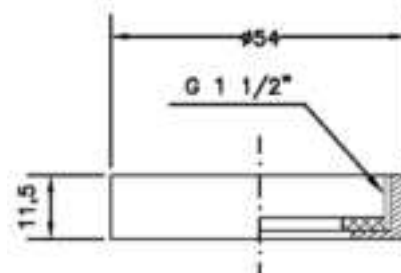

Ref.: 100134 08
 Carton: 1

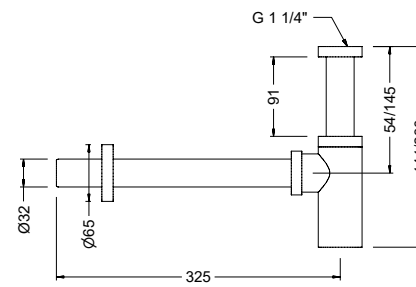

Ref.: 1622 07
 Box: 1 | Carton: 12 | Pallet: 216

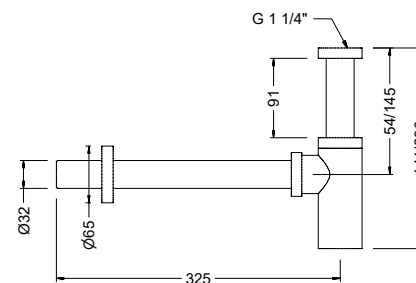

Ref.: 1626 41
 Box: 1 | Carton: 12 | Pallet: 216

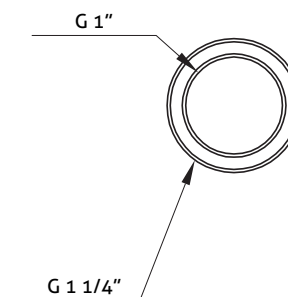

Ref.: 9908 0046
 Carton: 1

Accesorios. Accessories

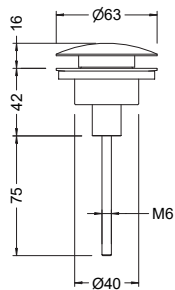

Ref.: 100202 45

Box: 1 | Carton: 60 | Pallet: 1080

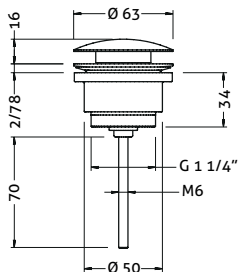

Ref.: 100211 45

Box: 1 | Carton: 60 | Pallet: 1080

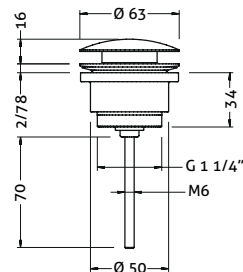

Ref.: 100211 41

Box: 1 | Carton: 60 | Pallet: 1080

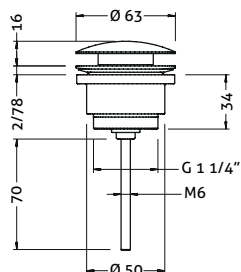

Ref.: 100211 43

Box: 1 | Carton: 60 | Pallet: 1080

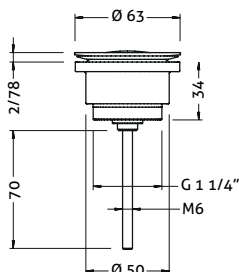

Ref.: 100205 45

Box: 1 | Carton: 60 | Pallet: 1080

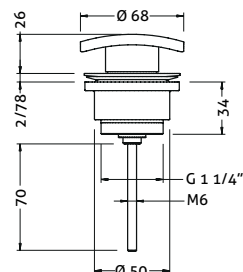

Ref.: 100204 45

Box: 1 | Carton: 60 | Pallet: 1080

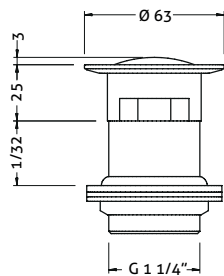

Ref.: 100206 45

Box: 1 | Carton: 60 | Pallet: 1080

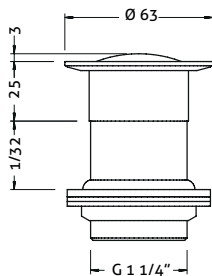

Ref.: 100207 45

Box: 1 | Carton: 60 | Pallet: 1080

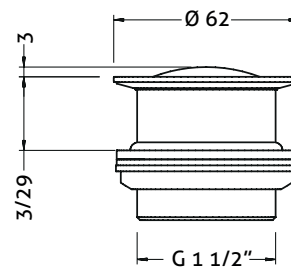

Ref.: 100208 45

Box: 1 | Carton: 80 | Pallet: 2160



Accesorios. Accessories

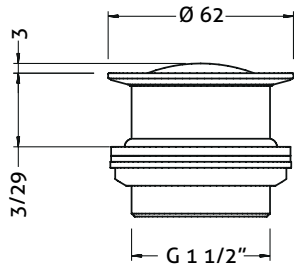

Ref.: 100208 43

Box: 1 | Carton: 80 | Pallet: 2160



9908 0154 | 9908 0156 | 9908 0347

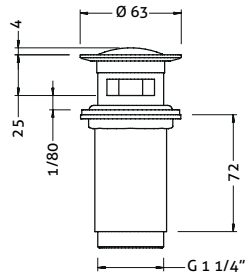

Ref.: 100209 45

Box: 1 | Carton: 60 | Pallet: 1080



9908 0152 | J100206 | 9908 0157 | 9908 0168

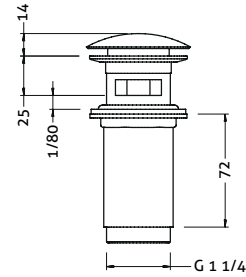

Ref.: 100210 45

Box: 1 | Carton: 60 | Pallet: 1080



9908 0152 | J100206 | 9908 0157 | 9908 0167



Ref.: 100200 45

| Carton: 100 | Pallet: 1200

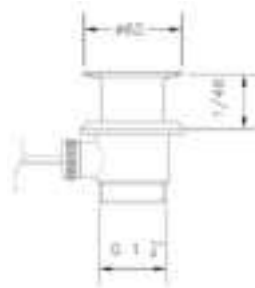

Ref.: 100203 45

| Carton: 60 | Pallet: 960



Ref.: 100122 45

Box: 1 | Carton: 72 | Pallet: 1728

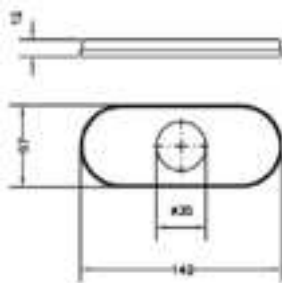

Ref.: P130

Box: 5 | Carton: 240 | Pallet: 4320

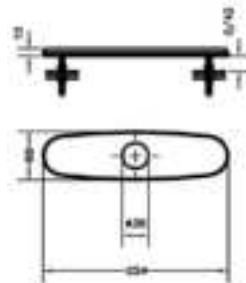

Ref.: P200

Carton: 1

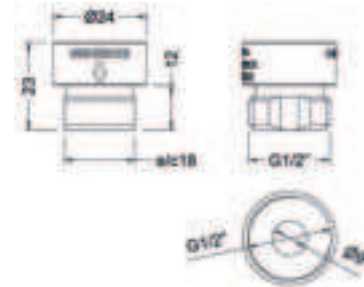

Ref.: 9908 0300 - 9908 0307

Box: 50 | Carton: 500 | Pallet: 14400

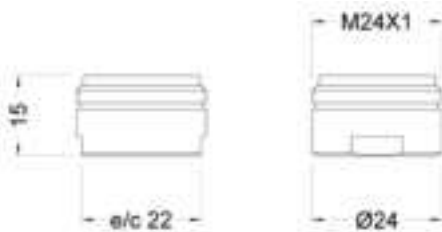

Ref.: 9908 0310 - 9908 0315

Box: 50 | Carton: 500 | Pallet: 18000



Ref.: 9908 0316 - 9908 0321

Box: 50 | Carton: 500 | Pallet: 18000

Índice por referencia

Index by reference

Localiza la referencia en este índice para encontrar la página donde ver el producto o la página para obtener su información técnica.

Locate the reference in this index to find the page where you can find the product or the page to get its technical information.



Información de producto
Product information



Información técnica
Technical information



Puedes ampliar información en:
You can get more information at:



www.genebre.es

Página | Page



Product



Technical Info

Ref.:	Product	Technical Info
100001 18 45	148, 205	
100001 22 45	148, 205	
100001 28 45	149, 205	
100001 29 45	149, 205	
100001 31 45	149, 205	
100001 32 45	149, 205	
100068 45	58, 189	283
100122 45	200	291
100135 51 00	188	
100135 52 00	188	
100135 60 00	50, 88, 102, 188	283
100137 60 00	58, 60, 188	283
100140 30	188	283
100141 45	188	283
100141 51	188	
100141 52	188	
100149 45	88, 189	283
100152 45 00	189	283
100153 41	189	
100153 45	50, 189	283
100153 51	189	
100153 51	189	
100153 52	189	
100175 45 00	96, 187	282
100197 45 00	50, 187	282
1002 04	103, 105	257
100200 45	197	291
100202 45	197	290
100203 45	197	291
100204 45	197	290
100205 45	197	290
100206 45	197	290
100207 45	197	290
100208 43	111, 197	291
100208 45	197	290
100209 45	197	291
100210 45	197	291
100211 41	197	290
100211 43	197	290
100211 45	197	290
100211 51	197	
100211 52	197	
1003 04	103	257, 280
10041 45	104	

Página | Page



Product



Technical Info

Ref.:	Product	Technical Info
1005 04	182	257, 280
1006 04	104	258, 280
100694 41	193	243, 287
100694 45	193	287
100694 51	193	
100694 52	193	
100694 60	193	287
100696 45	104, 193	287
100697 45	188	282
100698 45	188	282
100699 45	188	282
1007 04	104	258, 280
1008 04	182	257, 279
1009 04	182	257, 279
1023 04	103, 182	258, 280
1024 04	103, 182	258, 280
1155 04	192	284
115BOX	202	
116BOX	202	
118BOX	202	
1618 41	189	
1618 51	189	
1618 52	189	
1621 07	198	289
1622 07	198	289
1626 41	198	289
1626 51	198	
1626 52	198	
1632 00	198	
1633 04	189	283
1634 04	189	283
1635 04	189	284
1636 41	190	
1636 45	60, 190	282
1636 51	190	
1636 52	190	
1637 45	190	282
1638 45	102, 190	282
1639 45	190	282
1640 07	198	
1643 45	60, 191	284
1648 41	198	
1648 51	198	
1648 52	198	

Página | Page



Product



Technical Info

Ref.:	Product	Technical Info
1649 04	189	284
1650 41	198	
1650 51	198	
1650 52	198	
1667 45	102, 195	287
1668 41	195	288
1668 45	60, 195	288
1668 51	195	
1668 52	195	
1671 41	191	
1671 45	191	285
1671 51	191	
1671 52	191	
1672 45	191	285
1674 41	195	
1674 45	195	288
1674 51	195	
1674 52	195	
1679 04	189	284
1680 04	60, 102, 189	284
1698 45 00	102, 192	284
1744 41	51	244
1744 45	51	241
1745 45	67, 73, 76, 83, 144	249, 251
1746 45	91	254
1747 45	190	282
1748 45	190	282
1946 41	189	283
1946 51	189	
1946 52	189	
3104 04	193	285
3104 05	193	285
3106 04	193	285
3106 05	193	286
3109 04	193	286
3109 05	193	286
3110 03 41	193	285
3110 03 51	193	
3110 03 52	193	
3110 04 41	193	285
3110 04 51	193	
3110 04 52	193	
3113 05 41	193	
3113 05 51	193	

Página | Page



Product

Technical
Info

Ref.:	Product	Technical Info
3113 05 52	193	
568083 45	181	279
568104 45	181	278
568193 45	181	278
568195 45	181	278
568550 45	178	277
568555 45	178	277
568565 45	178	277
568575 45	178	277
60001 22 45 67	104	258
60100 22 45 66	101	257
60100 28 45 66	96, 97	255
60110 22 45 66	101	257
60110 28 45 66	96	256
60130 22 45 66	100	256
60130 28 45 66	94	254
60134 28 45 66	94	255
60136 28 45 66	94	255
60140 22 45 66	100	256
60140 28 45 66	95	255
60150 28 45 66	94	254
60154 28 45 66	94	255
60170 41 41 66	193	
60170 41 45 66	193	287
60170 41 51 66	193	
60170 41 52 66	193	
60171 41 41 66	194	287
60171 41 45 66	194	
60171 41 51 66	194	
60171 41 52 66	194	
60188 22 45 66	100	256
60188 28 45 66	95	255
60194 05 45 66	167	274
60198 05 45 66	157	271
60199 05 45 66	157	271
61115 22 45 66	101	257
61115 28 45 66	96	256
61116 22 45 66	101, 102	257
61116 28 45 66	96	256
61130 22 45 66	100	256
61130 28 45 66	94	255
61142 22 45 66	100	256
61142 28 45 66	95	255
61150 28 45 66	94	254

Página | Page



Product

Technical
Info

Ref.:	Product	Technical Info
61190 28 45 66	167	273
61192 28 45 66	167	274
61195 28 45 66	166	274
61196 28 45 66	166	274
61200 28 45 66	153	269
61201 28 45 66	153	269
61203 28 45 66	153	269
61204 28 45 66	153	269
61205 28 45 66	162	272
61206 28 45 66	162	272
61210 28 45 66	153	269
61900 28 45 66	168	274
62100 08 45 67	58	238
62110 31 45 67	58	238
62114 30 45 66	59	239
62115 31 45 66	59	239
62117 31 45 66	59	239
62118 31 45 66	59	239
62119 31 45 66	58	238
62130 08 45 66	56	238
62131 31 45 66	57	238
62132 31 45 66	57	238
62136 08 45 66	56	238
62140 08 45 66	57	238
62142 31 45 66	57	238
63100 26 45 67	88	253
63110 26 45 67	88	253
63114 30 45 66	127, 131, 135	264, 266, 267
63115 26 45 66	89	253
63116 26 45 66	89	253
63119 26 45 66	89	253
63130 26 45 66	86	252
63131 26 45 66	88	252
63132 26 45 66	88	252
63134 26 45 66	86	252
63136 26 45 66	86	252
63137 26 45 66		252
63138 26 45 66	86, 87	252
63140 26 45 66	88	252
63142 26 45 66	88	252
64100 16 45 66	65	245
64100 32 41 66	37	236
64100 32 45 66	37	234
64110 16 45 66	65	246

Página | Page



Product

Technical
Info

Ref.:	Product	Technical Info
64110 32 41 66	37	236
64110 32 45 66	37	234
64111 14 45 67	75	249
64114 14 45 67	75	249
64114 30 41 66	39	237
64114 30 45 66	39	235
64115 16 45 66	66, 144	246
64115 32 41 66	39	237
64115 32 45 66	39	234
64116 16 45 66	66, 67, 144	246
64116 32 41 66	39	237
64116 32 45 66	39	235
64117 04 45 66	66	246
64117 32 41 66	39	237
64117 32 45 66	39	235
64118 04 45 66	66	246
64118 32 41 66	39	237
64118 32 45 66	39	235
64119 32 41 66	38	237
64119 32 45 66	38	234
64130 16 45 66	64	245
64130 32 41 66	34, 35	236
64130 32 45 66	34	233
64131 16 45 66	65	245
64131 32 41 66	37	236
64131 32 45 66	37	234
64132 16 45 66	65	245
64132 32 41 66	36, 37	236
64132 32 45 66	37	234
64134 16 45 66	64	245
64134 32 41 66	34	236
64134 32 45 66	34	233
64136 16 45 66	64	245
64136 32 41 66	34	236
64136 32 45 66	34	234
64140 16 45 66	65	245
64140 32 41 66	37	236
64140 32 45 66	37	234
64142 16 45 66	65	245
64142 32 41 66	37	236
64142 32 45 66	37	234
64150 16 45 66	64	245
64150 32 45 66	34	233
64192 16 45 66	166	273

Página | Page



Product

Technical
Info

Ref.:	Product	Technical Info
64192 32 45 66	166	273
64201 04 45 66	152	268
64201 16 45 66	152	268
64201 32 45 66	152	268
64206 16 45 66	162	272
64206 32 45 66	162	272
64316 32 41 66	39	237
64316 32 45 66	39	235
65100 18 45 66	72	247
65100 19 41 66	50	243
65100 19 45 66	50	240
65100 29 45 66	81	250
65110 18 45 66	72	247
65110 19 41 66	50	243
65110 19 45 66	50	241
65110 29 45 66	81	250
65114 30 45 66	66, 74, 138	246, 247
65115 18 45 66	74, 138	247
65115 19 41 66	50	244
65115 19 45 66	50	241
65115 29 45 66	82	251
65116 18 45 66	74	247
65116 19 41 66	50	244
65116 19 45 66	50	241
65116 29 45 66	82	251
65117 18 45 66	74	247
65118 18 45 66	74, 140	247
65119 18 45 66	72	247
65119 29 45 66	82	250
65120 45	109, 194	259
65130 19 41 66	44	242
65130 19 45 66	44	239
65131 18 45 66	71	247
65131 19 41 66	48	243
65131 19 45 66	48	240
65131 29 45 66	80	250
65132 18 45 66	71	247
65132 19 41 66	48	243
65132 19 45 66	48	240
65132 29 45 66	80	250
65134 18 45 66	70	247
65134 19 41 66	44	242
65134 19 45 66	44	239
65134 29 45 66	80	250

Página | Page



Product

Technical
Info

Ref.:	Product	Technical Info
65135 18 45 66	70	247
65135 29 45 66	80	250
65136 18 45 66	70	247
65136 19 41 66	44, 45	242
65136 19 45 66	44	240
65136 29 45 66	80	250
65138 18 45 66	71	247
65139 19 41 66	46, 47	243
65139 19 45 66	47	240
65140 19 41 66	49	243
65140 19 45 66	49	240
65142 18 45 66	71	247
65142 19 41 66	49	243
65142 19 45 66	49	240
65142 29 45 66	81	250
65144 19 41 66	49	243
65144 19 41 67	49, 194	243
65144 19 45 66	49, 194	240
65144 19 45 67	49, 194	240
65144 19 51 67	194	
65144 19 52 67	194	
65145 18 45 66	71	247
65145 29 45 66	81	250
65150 19 45 66	44	239
65192 18 45 66	166	273
65192 19 45 66	167	273
65200 19 45 66	154	269
65203 18 45 66	152	269
65203 18 60 66	169	274
65203 19 45 66	154	270
65204 18 45 66	152	269
65205 18 45 66	162	271
65206 18 45 66	162	271
65207 18 60 66	165, 169	274
65211 18 45 66	165	272
65211 18 60 66	165, 169	274
65212 18 45 66	164, 165	273
65214 18 45 66	152	269
65215 18 45 66	155	270
65215 40 60 66	170, 171	275
65219 18 45 66	157	270
65219 40 60 66	169, 170	275
65403 18 40 66	155	
65403 18 41 66	155	

Página | Page



Product

Technical
Info

Ref.:	Product	Technical Info
65403 18 44 66	155	
65403 18 45 66	155	270
65404 18 45 66	154	270
65700 18 45 66	159	271
65702 18 41 66	159	
65702 18 44 66	159	
65702 18 45 66	159	271
65900 18 45 66	168	274
67100 26 45 67		253
67102 14 45 67	75	247
67103 14 45 67	66, 67	246
67104 14 45 67	66	246
67110 26 45 67	89	253
67112 14 45 67	75	247
68001 09 45 66	116	261
68001 11 45 66	122	263
68003 11 45 66	176	276
68083 11 45 66	180	278
68093 11 45 66	180	278
68100 11 45 66	120	262
68103 11 45 66	179	278
68104 11 45 66	179	278
68110 11 45 66	120	262
68113 07 45 66	135	264
68113 08 45 66	131	266
68113 12 45 66	127	267
68115 07 45 66	135	264
68115 08 45 66	131	266
68115 11 45 66	122	263
68115 12 45 66	127	267
68116 07 45 66	135	264
68116 08 45 66	131	266
68116 11 45 66	122	263
68116 12 45 66	127	267
68120 07 45 66	134	264
68120 08 45 66	130	265
68120 09 45 66	114, 117	260
68120 11 45 66	120	262
68120 12 45 66	126	267
68122 11 45 66	120	262
68124 07 45 66	134	264
68124 08 45 66	130	265
68124 12 45 66	126	267
68125 07 45 66	134	264

Página | Page



Product

Technical
Info

Ref.:	Product	Technical Info
68125 08 45 66	130	265
68125 12 45 66	126	267
68130 11 45 66	120	262
68131 07 45 66	134	264
68131 08 45 66	131	266
68131 09 45 66	116	261
68131 11 45 66	122	263
68131 12 45 66	127	267
68132 07 45 66	134	264
68132 08 45 66	131	266
68132 12 45 66	127	267
68140 11 45 66	120	262
68142 07 45 66	135	265
68142 08 45 66	131	266
68142 09 45 66	115	260
68142 11 45 66	120	262
68142 12 45 66	127	268
68160 11 45 66	120	262
68170 07 45 66	135	265
68170 08 45 66	131	266
68170 11 45 66	122	263
68170 12 45 66	127	268
68180 11 45 66	120	262
68190 11 45 66	180	278
68193 11 45 66	179	277
68194 09 45 66	174	276
68194 11 45 66	175	275
68195 11 45 66	179	278
68196 09 45 66	176	276
68196 11 45 66	179	277
68197 11 45 66	179	277
68199 11 45 66	175	276
68200 11 45 66	175	275
68201 39 43 66	172	275
68201 39 45 66	172, 173	
68500 09 45 66	115	260
68505 09 45 66	114	260
68506 09 43 66	110	259
68506 09 45 66	108	258
68510 09 45 66	114	260
68511 09 45 66	115	260
68515 09 45 66	115	260
68516 09 43 66	110	259
68516 09 45 66	108	258

Página | Page



Product

Technical
Info

Ref.:	Product	Technical Info
68520 09 45 66	115	260
68525 09 45 66	115	260
68526 09 43 66	110	259
68526 09 45 66	108, 109	259
68527 09 45 66	116	261
68530 09 45 66	115	261
68531 09 43 66	110	259
68531 09 45 66	108	259
68535 09 45 66	116	261
68540 09 45 66	174	275
68545 09 45 66	174	275
68550 09 45 66	176	276
68555 09 45 66	176	276
68560 09 45 66	176	276
68565 09 45 66	176	276
68570 09 45 66	176	276
68575 09 45 66	177	277
68580 09 45 66	177	277
68585 09 45 66	174	275
68590 09 45 66	116	261
68595 09 43 66	172	
68595 09 45 66	172	275
68901 45	178, 181	279
68902 45	178, 181	279
68904 45	178, 181	279
68908 45	178, 181	279
68909 45	178, 181	279
68910 45	178, 181	279
68911 45	195	288
68912 45	195	288
68913 45	195	288
68914 45	195	288
68915 45	195	288
68916 45	195	288
68917 45	195	289
69100 34 41 66	31	232
69100 34 45 66	31	232
69100 34 51 66	31	232
69100 34 52 66	31	232
69110 34 41 66	31	231
69110 34 45 66	31	231
69110 34 51 66	31	232
69110 34 52 66	31	232
69115 34 41 66	31	232

Página | Page



Product

Technical
Info

Ref.:	Product	Technical Info
69115 34 45 66	31	232
69115 34 51 66	31	232
69115 34 52 66	31	232
69116 34 41 66	31	233
69116 34 45 66	31	233
69116 34 51 66	31	233
69116 34 52 66	31	233
69130 34 41 66	27	229
69130 34 45 66	27	229
69130 34 51 66	27	229
69130 34 52 66	27	230
69131 34 41 66	28	230
69131 34 45 66	28	230
69131 34 51 66	28	230
69131 34 52 66	28	230
69132 34 41 66	28	230
69132 34 45 66	28	230
69132 34 51 66	28	230
69132 34 52 66	28, 29	230
69134 34 41 66	27	229
69134 34 45 66	27	229
69134 34 51 66	27	229
69134 34 52 66	27	230
69136 34 41 66	27	229
69136 34 45 66	27	229
69136 34 51 66	27	229
69136 34 52 66	26, 27	230
69140 34 41 66	28	230
69140 34 45 66	28	230
69140 34 51 66	28	231
69140 34 52 66	28	231
69142 34 41 66	28	
69142 34 45 66	28	
69142 34 51 66	28	
69142 34 52 66	28	
9908 0285	188	
9908 0287	188	283
9908 0300	199	291
9908 0301	199	291
9908 0302	199	291
9908 0303	199	291
9908 0304	199	291
9908 0305	199	291
9908 0306	199	291

Página | Page



Product

Technical
Info

Ref.:	Product	Technical Info
9908 0307	199	291
9908 0310	199	291
9908 0311	199	291
9908 0312	199	291
9908 0313	199	291
9908 0314	199	291
9908 0315	199	291
9908 0316	199	291
9908 0317	199	291
9908 0318	199	291
9908 0319	199	291
9908 0320	199	291
9908 0321	199	291
B115 40 10	148, 204	
B117 40 10	149, 204	
B118 40 10	149, 204	
B63113 26	191	285
B64113 41	191	285
B64113 43	191	285
B64113 51	191	285
B64113 52	191	
B65113 18	60, 102, 191	285
B65114 18	191	285
CM63110 26	91	254
CM64110 32	40, 41	235
CM64111 32 41	40	237
CM65110 18	76, 77	249
CM65110 19	51	241
CM65110 29	83	251
CM65111 19 41	51	244
CT67110 18	76, 83	249, 251
CT67110 19	51	242
CT67110 26	90, 91	254
CT67111 19 41	51	244
DXE2 45	102, 187	281
DXE5 45	187	281
DXK1 45	186	282
DXK3 45	88, 186	281
DXL3 41	186	
DXL3 41	186	
DXL3 41	186	
DXL3 45	186	
DXL3 45	186	
DXL3 51	186	

Página | Page



Product

Technical
Info

Ref.:	Product	Technical Info
DXL3 51	186	
DXL3 52	186	
DXL3 52	186	
DXO3 45	58, 60	281
DXO3 45	186	281
DXT3 45	186	281
DXT5 45	186	281
EXT0001	202	
EXT0002	202	
EXT0003	202	
EXT0004	202	
EXT0005	202	
EXT0006	202	
FRK63400	156, 157	270
FRK63401	157	270
FRT65401	155	270
FRT65402	154	270
FRV61205	162	272
FRV61206	161	271
FRV61207 40	161	
FRV61207 41	161	
FRV61207 44	161	271
FRV61208 41	161	
FRV61208 44	160, 161	271
FRV61208 45	161	
FT00	158, 159, 200	281
FT01	158, 159, 200	281
FT91	158, 200	
FT92	158, 200	
KPB115 40 45	148, 204	
KPB117 40 45	149, 204	
KPB118 40 45	149, 204	
KPC115 40 41	148, 205	
KPC115 40 45	148, 204	
KPC117 40 41	149, 205	
KPC117 40 45	149, 204	
KPC118 40 41	149, 205	
KPC118 40 45	149, 204	
KPT115 40 45	148, 204	
KPT117 40 45	149, 204	
KPT118 40 45	149, 204	
P130	200	291
P200	200	291
R63112 08	60, 192	284

Página | Page



Product

Technical
Info

Ref.:	Product	Technical Info
R63112 26	192	284
R65110 41	192	
R65110 51	192	
R65110 52	192	
R65110 60	192	
R65112 18	102, 191	284
R65112 41	191	284
R65130 41	192	
R65130 51	192	
R65130 52	192	
R65130 60	192	
R65150 60	192	
R65170 60	192	
R68113 43	111, 191	284
ST1111941	52, 53	
ST116 19	52	241

Condiciones Generales de Venta

General Sales Conditions



Ver Tarifa de Precios Grifería 2024
See Taps Collection 2024 Price List



PRECIOS: Los precios se entienden en nuestro almacén, siendo los portes, el I.V.A. y acarreo a cargo del comprador, salvo acuerdo previo en contra.

CONDICIONES DE PAGO: En aplicación de la Ley 15/2010 que limita los plazos máximos de pago en las operaciones comerciales, hemos ajustado las condiciones a lo dispuesto en la misma. En caso de diferirse el pago, los gastos de negociación de efectos y/o los intereses legales especificados serán a cargo del comprador. El impago de cualquier efecto o recibo, conllevará la inmediata suspensión de suministros y servicios.

PEDIDOS: Para la tramitación de cualquier suministro será indispensable que el comprador nos remita el pedido por escrito indicando claramente la referencia Genebre, incluidos los dígitos de la medida y también la cantidad deseada respetando las unidades de compra mínima (por caja), tal como especifica Genebre en su catálogo. El importe mínimo del pedido se establece en 50€ para pedidos del Mercado Nacional y de 100€ para pedidos comunitarios. Si existen condicionantes no previstos, Genebre S.A. se reserva el derecho de aceptación o anulación de los pedidos cursados. Cada pedido solicitado a Genebre S.A. genera una expedición para el cliente con su coste de transporte correspondiente; por lo que recomendamos preparen sus pedidos completos una vez al día para optimizar el transporte. Todos los pedidos serán confirmados por Genebre, S.A. vía email/fax. Salvo notificación de lo contrario en las siguientes 2 horas (Mercado Nacional), el pedido confirmado seguirá su curso sin derecho a posteriores reclamaciones.

TARIFAS DE PRECIOS: Genebre S.A. comunicará a sus clientes cualquier cambio que se produzca en las tarifas del catálogo a través de alguna de las vías de comunicación usuales (web, email, correo).

CANCELACIÓN DE PRODUCTOS DE CATÁLOGO:

Genebre, S.A. comunicará a sus clientes cualquier cancelación de productos del catálogo.

ESPECIFICACIONES TÉCNICAS: El catálogo de Genebre, S.A. contiene los requisitos técnicos y normas aplicables a los productos suministrados. Genebre S.A. se reserva la facultad de cambiar en todo o en parte el diseño y materiales de cualquiera de sus productos, debido a la mejora continua de nuestros productos.

EXPEDICIONES: Todo pedido superior a 500 euros en Península se suministran a portes pagados. Para Canarias, Ceuta, Melilla y Andorra, el pedido mínimo será de 1.000 euros. Las mercancías viajan siempre por cuenta y riesgo del comprador, aún en los casos de convenios especiales.

ENTREGA: Los pedidos se suministrarán siempre por cajas completas, según especificaciones de catálogo.

RECLAMACIONES: Las eventuales reclamaciones deberán formularse dentro de los 15 días siguientes al de recepción de la mercancía por el comprador, rechazándose las efectuadas después de dicho plazo límite. NO se aceptará ninguna devolución de material sin aprobación previa de nuestro Departamento Comercial que facilitará un número de boletín de devolución que debe acompañar al material devuelto. Todas las devoluciones serán con los portes a cargo del comprador. Y se realizará un cargo por demérito del 10% del valor de la mercancía para todos los materiales, excepto para las válvulas automatizadas que será del 30%.

GARANTÍA: Queda limitada al reemplazo de las piezas reconocidas como defectuosas de fabricación por el Departamento de Calidad de Genebre S.A.. No admitiremos ninguna reclamación transcurridos 15 días de la recepción de la mercancía por el comprador.

PROPIEDAD DE LA MERCANCÍA: Genebre, S.A. se reserva el derecho de propiedad de la mercancía suministrada, hasta que el comprador no haya satisfecho totalmente el importe de la misma. En el intervalo, se considerará en concepto de depósito y custodia. La mercancía podrá ser retirada por incumplimiento de pago en el plazo previamente estipulado.

LITIGIOS: En caso de litigio, ambas partes aceptan someter sus diferencias a los Juzgados de L'Hospitalet de Llobregat.

PRICES: Prices are considered to be EX WORKS, being the freight and transportation at the cost of the purchaser, unless previous agreement has been reached.

PAYMENT TERMS: We have adjusted the conditions in application of Law 15/2010 which limits the maximum terms of payment in commercial transactions. The maximum delay on payment will be of 60 days after invoice date. Payment term will be as accorded between the parties. In case of unpaid, the expenses and interest occurred will be paid by the purchaser. The unpaid maturity will imply the complete suspension of any service or supply.

ORDERS: Regarding the handling of any supply, it is compulsory for the purchaser to send a written signed and sealed purchasing order indicating clearly Genebre's reference, including measures digits, and also the quantity required subject to obligated minimum units of purchase (boxes), as Genebre's Catalogue specifies. The minimum order amount is set at €50 for National Market orders and 100€ for community orders. In case of unexpected discrepancies, Genebre has the right to accept or cancel the pending orders. Each order required to Genebre, S.A., opens a client expedition with corresponding transports cost, because of that, we recommend to prepare complete orders once a day to improve the transport. All the orders will be confirmed by Genebre by e-mail/fax. Each confirmed order will handled without any right from the purchaser to modify it, unless previous notification before 2 hours (National Market) after confirmation.

PRICE LIST: Genebre will inform the customers about any change in the price list, using some usual communication way (web, e-mail or post).

PRODUCTS WITHDRAWAL FROM CATALOGUE:

Genebre S.A. will inform the customers about any product withdrawal from the catalogue.

TECHNICAL SPECIFICATIONS: Genebres's catalogue holds all the technical requirements and applicable norms about the products.

SHIPMENT: Goods are shipped under the purchaser's own risk, even in special cases.

DELIVERY: Orders will always be shipped according to full boxes, as specified in the catalogue.

CLAIMS: Eventual claims must be done within 15 days after date of reception of the goods by the purchaser. Claims after such period will not be considered. NO devolution will be accepted without the previous approval from our Sales Department, who will issue a devolution certificate that must be enclosed in the devolution goods. All devolutions' freight will be paid by the purchaser. Additionally, an unworthiness debit of 10% of the products' value will be charged, except for the automatic valves that are a 30%.

GUARANTEE: It is limited to defective pieces replacement identified by Genebre's Quality Department. We will not accept any return after 15 days from the date of reception by the purchaser.

PROPERTY OF THE GOODS: Genebre has the property right of the supplied goods, until the purchaser has totally paid its value. In the meantime, it will be considered as deposit and custody. Goods shall be claimed in case of breach of payment terms.

DISPUTES: In case of disputes, both parties agree to solve discrepancies in the Barcelona Court of Justice.

GENEBRE

W A T E R C A R E V I S I O N E E R S

www.genebre.es

GENEBRE

WATER CARE VISIONEERS

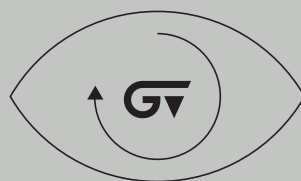

www.genebre.es